



NEUTRALPOSTURE NP



EQUITY

PRICE LIST

2024
February

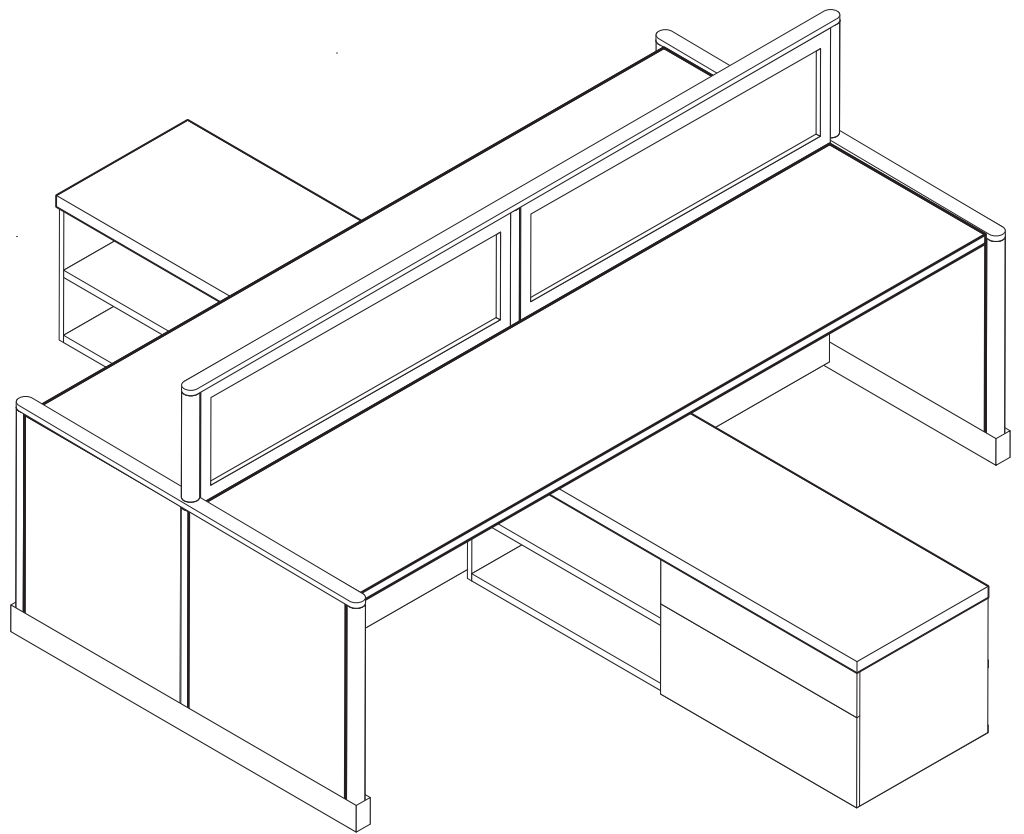

TABLE OF CONTENTS

GENERAL INFORMATION	4	PANELS	18	WORKSURFACES	70
Panels	4	Features	18	Features	70
Power	4	Construction	18	Wiring & Cabling	70
Raceway	4	Surface Materials	18	Edge Detail	70
Environmental Impact	4	Fabric Panels	20	Surface Materials	70
Storage	4	Insert Panels	22	General Information	72
Legacy Customers	4	Perforated Aluminum Insert Panels	24	Support Information	73
SUSTAINABLE DESIGN	5	Tequity Panels	26	Grain Direction	74
Manufacturing Process	5	Doors	28	Straights	76
Shipping Initiatives	5	Post Assemblies	30	Corners	78
TERMS AND CONDITIONS	6	End Kits	32	Split Corner	78
Ordering	6	Wall Starter/Wall Mounted Channel	33	Blended Corners	79
Pricing	6	Posts (Multi-height)	34	Corner Peninsulas	80
Taxes	6	Connectors/Shrouds	35	Peninsulas	81
Lead Time	6	STACK-ON PANELS	36	Half Round & Linking	82
Customer's Own Material	6	Components	36	Blended Double Corner	83
Storage Fee	6	Stack-on Panel Connectors	36	135° Curved Corner	83
Compliance with Law	6	Specifying Stack-on Configurations	36	Supports	84
Shipping	7	Stack-on Diagram	37	Legs	86
Accessorial Charges Freight Damage	7	Stack-on Configurations	38	Worksurface for Height Adjustable Supports	88
Delay/Force Majeure	7	Fabric with slots	40	Electric Height Adjustable Base	89
Returns	7	Fabric without slots	42	120° Planning	90
Warranty Claims	7	Insert with slots	44	120°	92
Warranty	8	Insert without slots	46	Transition Tops	94
Certifications & Standards	8	Perforated Aluminum Insert w/slots	48	CASCADE WORKSURFACES	95
Key-Alike Program	9	Perforated Aluminum Insert w/o slots	50	Cascade Edge	95
GSA Contract Overview	10	Stack-on Posts	52	Straights	96
GSA Contract Details	11	Panel Accessories	53	Corners & Extended Corners	97
Wall Mounting Suggestions	12	Frameless Glass	54	Corner Peninsulas	98
Wall Mounting Details	13	Frameless Glass Connectors	55	Waves	99
FINISHES	14	Add-on Screens	56	Rounds	100
Fabrics	14	Slat Rail	57	Accessories	101
Laminates	14	Slat Rail Accessories	57	Personal Drawer	101
Edge Bands	14	ELECTRICAL	58	Cable Management	101
Paints	15	How to Order	58	COUNTER CAPS	102
Plexiglass	15	Infeeds	60	Straights	102
Glass	15	Technical Data	61	Corners	103
Designer Glass	15	Ceiling Infeeds	62	PANEL SUPPORTED STORAGE	104
Corian	15	Base Infeeds	63	Open Shelves	104
Textured Corian	15	Components	64	Overheads	106
CUSTOM FINISHES PROGRAM	16	Knock-out Replacement Cover	64	Shared Storage	108
Customer's Own Fabric	16	Jumper	65	Tackboards	110
Customer's Own Laminate	16	Dedicated Neutral System Components	66	Wall Mounted Channel	111
Custom RAL Paint Finishes	16	Dedicated Neutral Jumpers	67	LIGHTING	112
LEGACY FINISHES	17	Charge Spot (Wireless Charger)	68	TASK	114
Legacy – Laminates	17	Desktop Data & Power	68	REED Premier	114
Legacy – Edge Bands	17	Ashley Duo	68	Tazetta	115
Legacy – Paint & Plastics	17	Ashley 202	68	Freestanding Lights	116
		Ashley Trio	69		
		Ashley Quad	69		

TABLES	118	STORAGE	134	WORKPLACE ACCESSORIES	174
Features	118	Accessory Availability	136	Keyboard Trays	176
Construction	118	Accessories	137	Keyboard Arms	176
Surface Materials	118	PEDESTALS	138	Easy Combos	177
OCCASIONAL	120	Features	138	Monitor Arms	178
Round	120	Construction	138	CPU Holders	178
Square	121	Surface Materials	138	Forearm Supports	179
CONFERENCE	122	Pedestals	140	Anti-fatigue Floor Mats	179
Oval	122	FILE CENTERS	142	Tablet Holder	179
Rectangle	123	Features	142	StandUp	180
DESKS	124	Construction	142	StandUp A1	181
C-Legs	124	Surface Materials	142		
O-Legs	124	File Centers	144	GRADED IN FABRICS	182
T-Legs	125	LATERALS	146	Carnegie	182
SIT/STAND DESKS	126	Features	146	C.F. Stinson	182
Electric Height Adjustable	126	Construction	146	Designtex	183
Stand-biased	127	Surface Materials	146	Guilford of Maine	183
SIT/STAND PACKAGES	128	Laterals	148	Luna	183
1000 Series Sit/Stand Packages	128	Lateral – BF	149	Luna	184
8000 Series Sit/Stand Packages	129	Lateral – Worksurface Supporting	149	Maharam	184
		Lateral – Lateral/Open Shelves	149	Mayer	184
SCREENS	130	Lateral – 6B, BBF & BBFF	150	Momentum	184
Privacy/Modesty Panels	130	Lateral – Common Tops	151		
Desktop	132	Lateral – Cushions	151	LEGACY	187
Mobile Privacy	133	TOWERS	152	LEGACY FINISHES	188
		Features	152	Laminate	188
		Construction	152	Edge Band	188
		Surface Materials	152	Paint	189
		24" Wide	154	Plexiglass	189
		24" Wide – Side Access	155	Fabric	189
		15" Wide	156	GEN 1 & 2	190
		15" Wide – Side Access	157	Panels	190
		CREDENZAS	158	Wall Starter & Wall Mount Chanel	194
		Features	158	Post Assemblies	195
		Construction	158	Panel Connectors	200
		Surface Materials	158	Shrouds	201
		Credenzas	160	GEN 3	202
		Credenza – Drawers	160	Panels	202
		Credenza – Shelves	160	Post Assemblies	204
		Accessories	160	Wall Starter/Wall Mounted Channel	207
		Credenza – Common Tops	161	Vertical Wire Manager	208
		Credenza – Cushion Tops	161	Metal Ceiling Module	208
		CABINETS	162	Coat Hook	209
		Features	162	Carpet Gripper	209
		Construction	162	Counter Caps	210
		Surface Materials	162	Flat Brackets	212
		Cabinets	164	Column Base	212
		LOCKERS	166	Tackable Privacy	213
		Features	166	WALL MOUNTING	214
		Construction	166	Wall Mounting Suggestions	215
		Surface Materials	166	KEY LOCK PROGRAM	216
		Lockers	168	General Information	216
		Lockers – Double	168	How to Specify Key Alike	216
		Lockers – Quad	168	Key-alike ordered prior to 6/12/00	217
		Lockers – Cubby	168		
		Lockers – Common Tops	169		
		BOOKCASES	170		
		Features	170		
		Construction	170		
		Surface Materials	170		
		Bookcases	172		

General Information

PANELS

Width dimension of all panels is centerline to centerline of adjacent panel connectors.

Panel thickness is 1½". Panel thickness at the base covers is 2".

FABRIC PANELS

Fabric panels incorporate a mineral wool core construction. Fabric panels are acoustical and fully tackable. The base raceway is nominally 5" high.

INSERT PANELS

Insert panels are constructed with a tapered aluminum frame that is mitered in the corners. Insert panels may be ordered with plexiglass, laminate, perforated aluminum or as an open frame for complete accessibility through the panel.

STACK-ON PANELS

Stack-on panels connect on the top of any standard panel to provide additional privacy or new aesthetic options and can also be load bearing.

PANEL CONNECTORS

Panel connectors are 1½" diameter and required at every panel connection and panel end (except when postless end assembly is used). Posts are painted to match the selected trim finish and include an adjustable glide on the bottom for leveling.

POWER

Fabric and insert panels accept electrical components.

Equity panels distribute power through the office and directly to the individual workstation through field-installed modular, electrical wiring components in the base of the panels. The panel base is factory prepared to accept a terminal block in a centered location where two 20-amp receptacles can be installed; one on each side of a panel, arranged back-to-back. An auxiliary side mount duplex receptacle is also available and plugs directly into the side of the terminal block connector end when a second duplex receptacle is required.

RACEWAY

The panel base cover provides openings for receptacles and/or communication outlets, which can be covered when not in use.

All panel bases provide a cable management segment to facilitate lay-in of workstation cables and cords.

CABLE CAPACITY

ELECTRICAL FILL	WITH		WITHOUT	
	100%	40%	100%	40%
Cat 5	36	14	102	40
Cat 6	28	11	80	32

STORAGE

All storage components come standard locking.

Master key and key alike are available upon request.

LEGACY PRODUCTS

Neutral Posture offers Legacy products for existing Equity which was ordered before February of 2016.

For any code compliance testing data,
please contact Customer Service at
customerservice@neutralposture.com
or 979.778.0502.

ENVIRONMENTAL IMPACT

Neutral Posture takes great pride in providing one of the most environmentally friendly furniture systems available on the market today.

Building an effective Green Program takes a company-wide effort, but we think it's worth the effort to ensure that our manufacturing process leaves the smallest possible footprint on the environment. Neutral Posture products are designed and manufactured to support a long and useful product life. Our products, if need be, can withstand repeated service, repairs and handling; and our products are made with standardized parts and components which make replacing worn out parts easy and as green as possible.

The steel and plastic materials used to construct Equity can be recycled after the product's life. The system is also designed to be cleaned with low environmental impact materials.

The clean technology used to manufacture the Equity system results in negligible off-gassing from the product.

We continually work with many 3rd party organizations to firmly establish a quality Sustainability Program.

- BIFMA level® Certification
- SCS Indoor Advantage Gold Certification
- LEED
- Underwriters Laboratories (UL)
- Canadian Standards Association (CSA)
- Occupational Safety and Health Administration (OSHA)
- ISO 9001:2015

GREEN MANUFACTURING PROCESS

Neutral Posture is highly efficient in its manufacturing process. New roll forming machines can change between parts with zero scrap. Current manufacturing efforts recycle process water and refrain from using hazardous process chemicals.

PLASTIC

Neutral Posture uses plastic which contains up to 25% pre-consumer recycled plastics. The majority of the plastics used in Neutral Posture products are #3 and #7 plastics and can be recycled in many areas.

STEEL & ALUMINUM

Neutral Posture products contain steel and aluminum that is 100% recyclable. Additionally, up to 25% of this steel comes from pre-consumer recycled product. Aluminum maintains a high scrap value and is known for having a very long working life.

FABRIC

Neutral Posture maintains an excellent supply of green fabrics. These fabrics are made from pre- and post-consumer recycled materials. Some fabrics contain 100% recycled materials and continues to divert recycled plastic from landfills, turning it into beautiful designs.

PANEL INNER

Neutral Posture uses mineral wool, spun from basalt and volcanic rocks to provide lightweight, sound resistant panels. These mineral wool inserts are considered rapidly renewable products.

WOOD

Wood worksurfaces and panels use 100% recycled/recovered wood fiber. All adhesives used in these products are virtually VOC-free and pass stringent emission standards.

GREEN SHIPPING INITIATIVES

Neutral Posture holds their freight carrier partners accountable to similar criteria as suppliers, however, due to the immense impact freight companies have on the environment, all carriers must also become a partner in the Environmental Protection Agency (EPA) SmartWay program within one year of service. All freight carriers are screened through a logistics company and become a partner associate with Neutral Posture based on annual evaluation reports.

PACKAGING OPTIONS

Our cardboard shipping boxes are produced from 45% recycled material and 100% of the materials come from renewable pulp sources. For large orders, customers can choose to use a box made from 100% recycled materials for an upcharge.

A LONG AND HEALTHY PRODUCT LIFE

Neutral Posture products are made to last, as is evidenced by our limited lifetime warranty. Neutral Posture has been around since the 1980s and it is not unusual to find original products from our first year of production in perfect working condition. Although we are continually improving our products, we allow for retrofitting of earlier generations. This allows the customer to upgrade individual components as desired without having to discard the product they already have or purchase a new one. This helps avoid filling landfills with used furniture and is another way in which Neutral Posture customers contribute to their immediate health and wellbeing as well as the continued wellness of our environment.

For more information about Neutral Posture's sustainability program, visit NeutralPosture.com/sustainability.

TERMS AND CONDITIONS

For all non-rated or new accounts, payment terms are Cash in Advance (C.I.A.) until credit has been approved or rated. Please send full credit information and references and allow time for Credit Department approval.

For all established accounts, payment is due within thirty (30) days from the invoice date. Neutral Posture (NP) reserves the right to change or cancel the terms of sale based on volume, credit rating and/or credit information. Prepayment, whole or in part, may be requested at any time at the discretion of the corporate office. For orders greater than \$100,000 net, a fifty percent (50%) deposit is due at the time of order placement, with the remainder due within thirty (30) days of the date of invoice.

Past due accounts are subject to a 1.5% late charge or maximum amount permitted under local law, for each thirty (30) days the outstanding balance remains open after the due date.

Withholding of payments based on carrier damages, shortages or other disputes is illegal and subject to charges.

Neutral Posture does not accept credit cards.

ORDERING

All orders must be in writing; faxed, emailed or mailed. The product model number(s) contained in the order acknowledgment shall be the final expression of the order. A purchase order is not binding on NP until customer has received NP's order confirmation or acknowledgment. Orders must have a contact name and phone number. Orders may not be canceled without written consent of Neutral Posture.

To expedite complete/correct entry of your order, be certain all model numbers, quantities, colors and area identifications are completely specified. Also, include complete purchase order number(s), bill-to and ship-to addresses, a contact name and specific factory shipping dates required.

Orders should be sent to:
Neutral Posture, Inc.
3904 N Texas Avenue Bryan, TX 77803
979.778.0502 (Option 2)
800.446.3746
979.778.0408 FAX
E-mail: orderentry@neutralposture.com

When an order is received, it is assigned a scheduled ship date. That date is shown on the order acknowledgment.

Purchase orders may not be changed or canceled, in whole or in part, without prior written consent of NP. Changes may affect delivery dates. Expenses incurred because of changes shall be charged to customer. In the event of cancellation, customer will be liable for reasonable cancellation charges as established by NP. Orders for special product, orders including customer's own material (COM) and orders pursuant to expedited delivery programs, may not be canceled.

An Expedite Fee of a minimum of 3% of net will be charged for orders requiring less than standard lead time.

PRICES

Prices are subject to change without notice. List prices shall be those in effect on the date of receipt of purchase order unless shipment is requested more than ninety (90) days after order entry in which case prices in effect on the date of shipment apply. Prices in effect at time of shipment prevails in the event of a discrepancy.

TAXES

All sales, use, excise and other taxes applicable to the sale of the products shall be paid by customer. If customer claims an exemption from any tax, customer shall submit to NP the appropriate exemption certificates.

LEAD TIME

Please contact Customer Service for current lead time at customerservice@neutralposture.com or 979.778.0502.

CUSTOMER'S OWN MATERIAL (COM)

A customer who requests a fabric or other surface material not standard to NP's line of products, must submit samples of the requested material to NP prior to entry of a customer order. NP shall determine if the material is suitable to its manufacturing processes and meets any requirements of Underwriters Laboratories and/or Canadian Standards Association. If the COM is acceptable, NP will then establish a price for using the COM. For a description of the procedures for submitting samples and testing, contact Customer Service. NP shall have no responsibility for the appearance, condition, performance, durability, colorfastness or any other physical attribute of the COM. Customer shall indemnify and hold NP harmless for any damages, injuries or losses arising out of or related to use of the COM on the product.

STORAGE FEE

Any changes made by the customer to postpone the delivery date on orders which have already gone into production, will be charged a storage fee. This fee will be applied to both partially and fully built orders. NP will advise of fee prior to applying charge.

COMPLIANCE WITH LAW

Customer is solely responsible for compliance with all applicable federal, state and local laws, ordinances, regulations, rules and standards relating to the installation, maintenance, use and operation of the products.

TERMS AND CONDITIONS

SHIPPING

All standard discount orders are F.O.B origin prepaid and add, delivered by way of parcel or freight carrier dock to dock. NP will designate the shipping mode and carrier based on geographical location and best service as defined by our Logistics Department.

Any order requiring special delivery services other than normal dock-to-dock delivery will incur additional charges. These services include but are not limited to residential delivery, limited access delivery, palletization, lift gate service, inside delivery, call before delivery, re-routed deliveries, specific delivery date/time requests, or congestion fees. These charges will be quoted upon customer request.

Conditions beyond the control of NP, including weather, available facilities, and traffic conditions, may affect the exact delivery time. NP shall not be responsible for a specific carrier delivery date or time unless it has made a specific delivery commitment in writing.

Delivery date and time are at the discretion of the carrier within reasonable transit time unless special arrangements have been agreed to in writing between the customer and NP prior to shipment.

Accessorial Charges (including but not limited to)

Delivery Appointment Required
Inside Delivery/Pick Up
Items Over 96 Inches
Lift Gate Required
Limited Access Delivery
Notification/CBD
Residential Delivery
Ship Fully Assembled
Pre-delivery Notification
Re-delivery/Return Trip
Palletization
Secure Locations

Limited-access Locations (including but not limited to)

Individual (mini) storage units
Places of worship
Schools
Commercial establishments not open to walk-in public
Construction sites
Fairs or carnivals
Prisons, jails, correctional facilities
Military base/installations
Mine sites
Sites requiring security inspections prior to pick up or delivery.
Wind farm sites
Airports

Contact Customer Service at
customerservice@neutralposture.com or
979.778.0502 Option 2 for pricing.

DELAY/FORCE MAJEURE

NP shall not be liable for failure to perform or for delay in performance due to fire, flood, strike or other labor difficulty, act of God, act of any governmental authority or of the customer, riot, embargo, fuel or energy shortage, wrecks or delay in transportation, inability to obtain necessary labor, materials or manufacturing facilities from usual sources or failure of suppliers to meet their contractual obligations, or due to any cause beyond its reasonable control. If any such

event occurs, NP may extend delivery dates by a period of time necessary to overcome the effect of such delay, allocate available product or cancel any purchase order.

FREIGHT DAMAGE

Upon receipt of shipment consignee is responsible for checking delivery for shortages or signs of damage. If a problem is discovered, bring it to the driver's attention immediately. If any of the goods called for on the Bill of Lading are shorted or damaged, consignees should not accept them until the carrier makes a notation on the freight bill of the shorted or damaged goods. The more precise the notation, the easier the claim can be resolved. NP's responsibility ceases when the consignee signs the freight delivery receipt as received in good condition. Shipping claims must be made within thirty (30) days of shipment delivery.

RETURNS

The return of product without written authorization by NP shall not be accepted. All merchandise returns must be pre-approved by the corporate office and sent freight prepaid. Contact the Warranty Department, warrantyrequest@neutralposture.com, to receive a Return Merchandise Authorization (RMA) number for any return. RMAs are valid for thirty (30) days and any returned merchandise without a RMA number will be refused.

No deductions from any NP invoices can be made for return merchandise until it is approved by the corporate office. No deductions will be honored until returned goods are processed through our Quality Control Audit.

All returns for canceled orders must be pre-approved by the corporate office and sent freight prepaid. No returns will be authorized unless our inventory allows it, the parts are in good reusable condition and it was sold within the last thirty (30) days. Authorized seating returns will be charged a thirty percent (30%) (twenty percent (20%) for GSA) restocking fee, by agreement, to cover handling, inspection, stocking and repackaging. Authorized systems returns are subject to a forty-five percent (45%) of list restocking charge. Products not currently offered for sale by NP (including COM) shall not be authorized for return. All returned products must be unused, in original condition and in the original NP packing cartons. No refund or credit will be given for damaged products.

WARRANTY CLAIMS

NP reserves the right to specify that items or parts claimed to be defective, be returned to the factory for our inspection. If the claim is justified, repair or replacement of defective parts under warranty will be made through NP at no cost to the customer. NP will, at its discretion, reimburse the furniture dealer for labor (actual costs only) on warranty parts. The furniture dealer must submit a quote to be approved prior to service. If approved, the furniture dealer must then submit an invoice to NP for reimbursement after the service is completed. Freight for products and parts covered under warranty will be covered for the forty-eight (48) contiguous states and the District of Columbia, with the method of shipping at NP's discretion. All claims must include the product serial number. NP will have no warranty obligation if the product was subjected to abuse, alteration, misuse, negligence or accident or if the user fails to perform the proper maintenance for the product.

warrantyrequest@neutralposture.com

Selling Policy

WARRANTY

Neutral Posture warrants to the original purchaser only that the products Neutral Posture manufactures and sells to purchaser are free of defects in workmanship and materials, during the applicable warranty period set forth below.

This comprehensive warranty applies to all products installed or reconfigured by an authorized installer.

Warranty period set forth below is for 24-hour, 7 days a week, multi-shift use. Should any failure occur to a product listed below during the applicable warranty period from the date of shipment, Neutral Posture shall, upon prompt written notice, repair or replace, at its discretion, the affected part or parts.

PRODUCT AND PERIOD OF WARRANTY

Lifetime

Panels and panel connector parts, high pressure laminate worksurfaces, table tops and common tops, storage

10 Years

Cascade worksurfaces, height adjustable worksurface supports (except for gas lift), laminate overhead doors, sliding doors, desktop and storage accessories (unless otherwise specified)

5 Years

Table bases, tapered table legs, anti-fatigue mats, operational parts, controls, electrical, lighting (except light ballasts, bulbs and power supply), special or custom product, height adjustable worksurface support gas lift, modesty/privacy screens, mobile screens, desktop screens

3 Years

Electric height adjustable bases (including motor), fabric

1 Year

Light ballasts, bulbs and power supply

This warranty does not apply to:

- Damage caused by a carrier.
- Normal wear and tear or acts or omissions of parties other than Neutral Posture (including user modification, improper use or installation of products).
- COM or other third party materials applied to products.
- Products not installed by or under the auspices of a Neutral Posture Dealer.
- Dramatic temperature variations or exposure to unusual conditions.
- Changes in surface finishes including colorfastness due to aging or exposure to light.

The express warranties contained herein are in lieu of all other warranties, express or implied, including any warranties of merchantability and fitness for particular purpose and all other warranties arising from course of dealing or usage of trade.

The remedies provided above are the customer's sole remedies for any failure of Neutral Posture to comply with its obligations regarding the workmanship of its products. Correction of any nonconformity in the manner and for the period of time provided shall constitute complete fulfillment of all liabilities of Neutral Posture, with respect to or arising out of the product furnished hereunder.

CERTIFICATIONS & STANDARDS

ANSI/BIFMA

Independent tests show that Equity components meet or exceed current ANSI/BIFMA X5.6 Panel System and ANSI/BIFMA X5.9 Storage Unit standards. Electrical components are UL listed. Panels have tested to NRC ratings of 0.75.

SCS INDOOR ADVANTAGE CERTIFICATION

The Equity product line is certified by SCS Global Services for indoor air quality.

DESIGN

NP reserves the right to make changes and improvements in design and materials and to discontinue parts and components at their discretion.

WOMEN'S BUSINESS ENTERPRISE (WBE)

This certification is administered by the Women's Business Enterprise National Council (WBENC) and is used by most large corporations to qualify potential vendors as credible diversity suppliers.

WOMAN OWNED SMALL BUSINESS (WOSB)

The U.S. Small Business Administration's WOSB Federal Contract Program provides greater access to federal contracting opportunities for WOSBs. The program allows contracting officers to set aside specific contracts for certified WOSBs and helps federal agencies achieve the existing statutory goal of five percent of federal contracting dollars being awarded to WOSBs. NP is certified as a WOSB.

HISTORICALLY UNDERUTILIZED BUSINESS (HUB)

The Texas Historically Underutilized Business (HUB) program encourages the use of HUBs in state procurement and provides information to minority and woman-owned businesses on the state's procurement process.

BUSINESS AND INSTITUTIONAL FURNITURE

MANUFACTURER'S ASSOCIATION

NP is a member of the Business and Institutional Furniture Manufacturer's Association (BIFMA). Tests developed by BIFMA and approved by the American National Standards Institute (ANSI) determine the strength and durability of office furniture in its everyday use. Although this testing does not serve as a warranty or guarantee, NP standard products within this price list meet or exceed applicable ANSI/BIFMA X5.6 Panel Systems and ANSI/BIFMA X5.9 Storage Unit standards. Combinations of options added on to the standard products may not meet ANSI/ BIFMA standards. Those combinations which do not meet ANSI/BIFMA standards are not available on GSA. Additionally, Equity is BIFMA level 2 certified. For more information, contact Customer Service at customerservice@neutralposture.com.

GENERAL INFORMATION

Neutral Posture pedestals, overheads and storage cabinets ship with lock cores. The locks are field installed. If your purchase order does not specify key-alike you will automatically receive random lock cores with your order.

Neutral Posture furniture can be keyed-alike or random keyed.

KEY-ALIKE

Furniture may be keyed alike at no charge if specified with a furniture order. Write "key-alike" in the description of your purchase order for any storage piece you wish to have keyed alike.

Using the key-alike instructions, order cores and keys as line items on your purchase order. Neutral Posture will select key numbers from the standard range of 226 – 425. Key numbers will not be repeated unless over 199 sets are ordered.

There is no charge for key-alike orders if placed with the furniture order.

If product is ordered and shipped random-keyed, additional lock cores for key-alike are billable.

KEYS

A key is shipped with every lock core. 199 key numbers are available. For numbers above 199, contact Customer Service. Additional keys and key blanks are available.

MASTER KEYING

Neutral Posture locks can be controlled by means of a master key. There is no additional per-lock charge for master keying. Master keys must be ordered separately. See service parts below for master key model # and pricing.

INSTALLING LOCK CORES

Lock cores can be installed or removed in the field by using a change key. Cores must be in the unlocked position to be removed. See service parts below for change key model number and pricing.

SERVICE PARTS

MODEL #	DESCRIPTION	LIST
NLCKE_ _ _	Shrouded Key (<i>Specify key number desired</i>)	\$21
NAKC	Change Key	\$21
NKM	Master Key	\$21

NOTE: A letter of approval on company letterhead from the client must accompany all orders for change and master keys.

NOTE: Neutral Posture locks/keys are not compatible with Knoll Equity pedestals/double pedestals.

HOW TO SPECIFY KEY-ALIKE

Following is an example of how to specify key-alike for a cluster of 10 workstations.

STEP 1

Using the project floor plan, count the number of locks in each workstation.

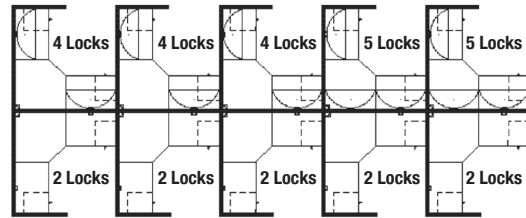

STEP 2

Count the number of workstations with the same quantity of locks. Group together the workstations with a like number of locks.

3 workstations with 4 locks per station 2 overhead w/laminate fronts
 2 workstations with 5 locks per station
 5 workstations with 2 locks per station

STEP 3

For the first group (3 sets of 4 locks), enter the number of workstations in the quantity column.

QTY	MODEL #	DESCRIPTION	UNIT LIST	EXT LIST
3	NSPEC4	Set of 4 cores/keys	N/C	N/C

STEP 4

Then enter the model number "NSPEC_ _" and add a suffix for the number of locks for that group (i.e., for 2 locks per station, add the suffix "2"). Up to 30 lock cores are available in a set (i.e., NSPEC 30).

QTY	MODEL #	DESCRIPTION	UNIT LIST	EXT LIST
3	NSPEC4	Set of 4 cores/keys	N/C	N/C

STEP 4b

If the station has overheads w/laminate fronts add a suffix for the number of locks needed for the overheads w/laminate fronts for that group (i.e., for 2 overhead laminate front locks per station, add the suffix "OL2").

QTY	MODEL #	DESCRIPTION	UNIT LIST	EXT LIST
3	NSPEC4OL2	Set of 4 cores/keys, 2 for overheads w/laminate fronts	N/C	N/C

STEP 5

Repeat for other groups.

QTY	MODEL #	DESCRIPTION	UNIT LIST	EXT LIST
3	NSPEC4OL2	Set of 3 cores/keys	N/C	N/C
2	NSPEC5	Set of 5 cores/keys	N/C	N/C
5	NSPEC2	Set of 2 cores/keys	N/C	N/C

Your key instructions are complete.

Neutral Posture will select key numbers for each set from 199 available numbers.

For additions to existing installations, specify desired key numbers in the description.

GSA Contract Overview

GSA CONTRACT

We have had a contract with GSA for over 25 years and they continue to be our most favored customer.

NP is dedicated to helping government agencies meet their facilities and acquisition needs. NP is registered with the System For Award Management (SAM) formerly Central Contractor Registry (CCR) with ORCA certifications, has an assigned cage code of OUTL8 and is eligible to receive federal contract awards. NP is also recognized as a Woman Owned Small Disadvantaged Business by the U.S. Small Business Administration (SBA).

WOMEN-OWNED SMALL BUSINESS (WOSB)/ ECONOMICALLY DISADVANTAGED WOMEN- OWNED SMALL BUSINESS (EDWOSB)

The U. S. Small Business Administration (SBA) issued the Final Rule to amend its regulations governing small business contracting procedures. The SBA has increased the emphasis and awareness of contracting mandates regarding the new 5% spend mandate for WOSB/EDWOSB's similar to those in place for 8a, SDV and HUB Zone businesses.

The SBA has also implemented a Sole Source vehicle for Economically Disadvantaged Women-Owned Small Businesses (EDWOSB). Neutral Posture, a small business manufacturer, received this certification in April of 2016.

Our Packaged Office contract includes many great manufacturing partners and we are willing to team with other manufacturers to support strong GSA Dealers and meet the needs of our customers.

For more information please visit
NeutralPosture.com/WOSB

GSA OVERVIEW

GSA Contract# GS-27F-0014Y

Schedule MAS – Furniture

SIN 337121H	Household, Dormitory & Quarters Furniture
SIN 337127	Institutional Furniture
SIN 33721	Office Furniture
SIN 33721P	Packaged Office Furniture
SIN OLM	Order Level Materials

NAICS CODES

337127	Institutional Furniture Manufacturing
337211	Wood Office Furniture Manufacturing
337214	Office Furniture (except wood) Manufacturing
423210	Furniture Merchant Wholesalers

NP products may be found on GSA Advantage.

NOT AVAILABLE ON GSA

Products not available on GSA as of February 2024.

SEATING

Guardian Panels

DESKS/TABLES

Desks – C-legs

Desks – O-legs

Desks – T-legs

Sit/Stand Desks

Sit/Stand Packages

TERM DATE 6/26/2012 – 6/26/2027

- 1a. Special Item Numbers Awarded**
 - SIN 337121H Household, Dormitory & Quarters Furniture
 - SIN 337127 Institutional Furniture
 - SIN 33721 Office Furniture
 - SIN 33721P Packaged Office Furniture
 - SIN OLM Order Level Materials
- 1b. Lowest Priced Item**
 - SIN 337121H Contact Corporate Office
 - SIN 337127 Contact Corporate Office
 - SIN 33721 SPTRY Pencil Tray \$5.95
 - SIN 33721P Contact Corporate Office
- 1c. Installation Rate — SIN 33721**
 - \$51.50 per hour (non-union inclusive IFF)
 - \$106.25 per hour (union inclusive of IFF)
- 2. Maximum Order**
 - SIN 337121H \$1,000,000
 - SIN 337127 \$250,000
 - SIN 33721 \$250,000
 - SIN 33721P \$5,000,000
 - SIN OLM \$0
- 3. Minimum Order**
 - All SINS \$50
- 4. Geographic Coverage**
 - CONUS & OCONUS
- 5. Point of Production**
 - 3904 N. Texas Avenue, Bryan, 77803, Brazos County, TX, USA
- 6. Discount from List Price**
 - Seating/Workplace Accessories**
 - SIN 33721 — Discount 60%

 - Systems**
 - SIN 33721 — Discount 70%
- 7. Quantity Discounts**
 - No discount tiers have been negotiated.
- 8. Prompt Payment Terms**
 - Net 30 Days
- 9. Government Purchase Cards Accepted**
 - Visa/Master Card
- 10. Foreign Item**
 - None
- 11a. Time of Delivery**
 - 5 – 90 days after receipt of order
- 11b. Expedited Delivery**
 - Expedited delivery available. Contact Customer Service.
- 11c. Overnight and 2-day Delivery**
 - Available with an upcharge. Contact Customer Service.
- 12. F.O.B. Origin**
 - Freight Prepaid.

- 13. Ordering Address**
 - Neutral Posture, Inc.
 - attn: Order Entry/ * or dealer
 - 3904 N. Texas Avenue
 - Bryan, TX 77803
 - 979.778.0502
 - 800.446.3746
 - fax 979.778.0408
 - orderentry@neutralposture.com
 - * Authorized Dealers should be cited on order
- 14. Payment Address**
 - Neutral Posture, Inc.
 - 3904 N. Texas Avenue
 - Bryan, TX 77803
- 15. Warranty Provision**
 - Neutral Posture’s commercial warranty applies.
- 16. Export Packing Charges**
 - Contact Customer Service for quote.
- 17. Terms and Conditions of Government Purchase Card**
 - Government purchase cards will be accepted for purchases at prices shown in this authorized price list (no additional discount offered).
- 18. Terms and Conditions Of Rental, Maintenance, and Repair**
 - Not applicable
- 19. Terms and Conditions of Installation**
 - Installation and instruction are available from authorized dealers. Please contact your local NP Dealer for pricing.
- 20. Terms and Conditions of Repair Parts**
 - Repair parts are offered at the agreed upon discount from the NP repair parts price list in effect at the time the repair parts are ordered.
- 20a. Terms and Conditions for Any Other Services**
 - GSA has accepted all of our standard terms and conditions as noted on page 6–8.
- 21. List of Service and Distribution Points**
 - Not applicable
- 22. List of Dealers**
 - Please contact Customer Service, or visit NeutralPosture.com for the name of your nearest authorized Dealer.
- 23. Preventive Maintenance**
 - Not offered or applicable
- 24. Environmental Attributes**
 - Not applicable
- 25. Other Information**
 - Tax Identification Number (TIN): 74-2983577
 - Unique Entity ID EYTGAM8GGLJ3
 - DUNS: 61-0339723
 - Cage Code: 0UTL8
 - NAICS: 337214
- 26. SAM**
 - NP is registered in System For Award Management (SAM).

NOTE: It is mandatory that all Government purchase orders be made out to NP only. Local Dealers are not authorized to accept purchase orders, issue invoices or receive payment of Government funds for these items without serious violation of this Federal Supply Schedule Contract.

WALL MOUNTING SUGGESTIONS

The following information is provided only as a guide and represents minimum recommendations only. Neutral Posture does not accept responsibility for the attachment of any Neutral Posture product to a customer's site wall. Wall specification/construction is the responsibility of the customer and its structural engineer/architect. Failure to properly attach Neutral Posture products to adequate wall structures can lead to property damage and/or personal injury.

You should consult your own structural engineers and/or architects and must not rely on the information provided herein.

It is the responsibility of the customer and its structural engineers/architects to verify that the permanent structural walls (studs, blocks, solid masonry, etc.) on which the

Neutral Posture products are intended to be mounted are designed appropriately to support the product weight, PLUS 3 lbs. per linear inch for each usable shelf length.

NOTE: A cabinet's top is considered a "usable shelf" and MUST be included in the calculation of the total load for an overhead cabinet.

It is the responsibility of the customer and its structural engineer/architects to specify the fasteners and method for attaching the Neutral Posture supplied wall mounting cleat, bracket, frame, etc. to the supporting wall and to confirm that the installers have adhered to these specifications. For all local building standards and codes, and additional requirements (including, but not limited to, seismic conditions) the customer should always consult local code agencies.

New Construction

Existing Construction

	Cinder Block or Poured Concrete Masonry Wall	Wood Stud Wall, the studs being FULL HEIGHT to the roof/floor above	Wood Stud Wall, the studs being only ceiling height	Steel Stud Wall, the studs being FULL HEIGHT to the roof/floor above	Steel Stud Wall, the studs being only ceiling height	
Stud Specification	Wood studs, grade #2 or better, 3 1/2" minimum width, OR Metal studs, minimum 25 gage thickness, 3 5/8" minimum width	Wood studs must be Grade #2, or better, 3 1/2" minimum width	Wood studs must be Grade #2, or better, 3 1/2" minimum width	Metal studs must be minimum 25 gage thickness, 3 5/8" minimum width	Metal studs must be minimum 25 gage thickness, 3 5/8" minimum width	
Stud Centers	Metal and wood studs must be spaced at 16" c/c maximum.	N/A	Wood studs must be spaced at 16" c/c maximum.	Wood studs must be spaced at 16" c/c maximum.	Metal studs must be spaced at 16" c/c maximum.	
Stud Height	Metal and wood studs must extend upwards, and be securely attached to the roof/floor structure above.		Wood studs must be braced above the ceiling, and be securely attached to the roof/floor structure above Affix #2 grade 'cap' across the top of the studs, then place diagonal studs from the top cap up to underside of the roof/floor structure above.		Metal studs must be braced above the ceiling and be securely attached to the roof/floor structure above Affix metal bracing 'cap' across the top of the studs. Then place diagonal studs from the top cap up to underside of the roof/floor structure above.	
Mounting the Neutral Posture Supplied Cleat, Bracket, Frame, etc	<p>Insert a 2" x 6" wood block, #2 grade or better, [or a locally approved flexible wood backing system] horizontally between each of the studs to accommodate the full width of the cabinet and beyond to the next stud.</p> <p>Fasten the wood block to each stud using three screws at the ends of each block.</p> <p>(Fasten the locally approved wood backing system as directed by the manufacturer.)</p> <p>Fasten the Neutral Posture supplied wall mounting cleat, bracket, frame, etc directly to each wood block every 6".</p> <p>For wall mounting structures that have a rectangular frame-like configuration: fasten the top horizontal element of the frame to the wood blocking every 6" and fasten the lower horizontal element to each wall stud, using one fastener per stud.</p>	<p>Fasten the Neutral Posture supplied cabinet wall mounting cleat, bracket, frame, etc. directly to the masonry wall every 6".</p> <p>For wall mounting structures that have a rectangular frame-like configuration: fasten the top horizontal element of the frame to the wall every 6" and fasten the lower horizontal element to the wall every 16".</p>	<p>In the desired location of the cabinet mounting rail, remove an 8" high section of drywall the width of the cabinet and beyond to the next stud.</p> <p>Insert a 2" x 6" wood block, #2 grade or better, horizontally between each of the exposed studs.</p> <p>Fasten the wood block to each stud using three screws at the ends of each block.</p> <p>Replace the drywall and repair as desired.</p> <p>Fasten the Neutral Posture supplied wall mounting cleat, rail, frame, etc directly to the wood block every 6".</p> <p>For wall mounting structures that have a rectangular frame-like configuration: fasten the top horizontal element of the frame to the wood blocking every 6", and fasten the lower horizontal element to each wall stud, using one fastener per stud.</p>	<p>In the desired location of the cabinet mounting rail, remove an 8" high section of drywall the width of the cabinet and beyond to the next stud.</p> <p>Insert a 2" x 6" wood block, #2 grade or better, horizontally between each of the exposed studs.</p> <p>Fasten the wood block to each stud using three screws at the ends of each block.</p> <p>Replace the drywall and repair as desired.</p> <p>Fasten the Neutral Posture supplied wall mounting cleat, rail, frame, etc directly to the wood block every 6".</p> <p>For wall mounting structures that have a rectangular frame-like configuration: fasten the top horizontal element of the frame to the wood blocking every 6", and fasten the lower horizontal element to each wall stud, using one fastener per stud.</p>	<p>In the desired location of the cabinet mounting rail, remove an 8" high section of drywall the width of the cabinet and beyond to the next stud.</p> <p>Insert a 2" x 6" wood block, #2 grade or better, [or a locally approved flexible wood backing system] horizontally between each of the exposed studs.</p> <p>Fasten the wood block to each stud using three screws at the ends of each block.</p> <p>Replace the drywall and repair as desired.</p> <p>Fasten the Neutral Posture supplied wall mounting cleat, rail, frame, etc directly to the wood block every 6".</p> <p>For wall mounting structures that have a rectangular frame-like configuration: fasten the top horizontal element of the frame to the wood blocking every 6", and fasten the lower horizontal element to each wall stud, using one fastener per stud.</p>	<p>In the desired location of the cabinet mounting rail, remove an 8" high section of drywall the width of the cabinet and beyond to the next stud.</p> <p>Insert a 2" x 6" wood block, #2 grade or better, [or a locally approved flexible wood backing system] horizontally between each of the exposed studs.</p> <p>Fasten the wood block to each stud using three screws at the ends of each block.</p> <p>Replace the drywall and repair as desired.</p> <p>Fasten the Neutral Posture supplied wall mounting cleat, rail, frame, etc directly to the wood block every 6".</p> <p>For wall mounting structures that have a rectangular frame-like configuration: fasten the top horizontal element of the frame to the wood blocking every 6" and fasten the lower horizontal element to each wall stud, using one fastener per stud.</p>
Fasten the Neutral Posture Supplied Wall Cleat With...	#10 x 2 1/2" wood screws or equiv. in every mounting hole provided, screwed directly into the wood blocking	3/16" x 3 1/2" masonry screws or equiv. in every mounting hole provided with 1 1/4" embedment, screwed directly into the masonry wall	#10 x 2 1/2" wood screws or equiv. in every mounting hole provided, screwed directly into the wood blocking	#10 x 2 1/2" wood screws or equiv. in every mounting hole provided, screwed directly into the wood blocking	#10 x 2 1/2" wood screws or equiv. in every mounting hole provided, screwed directly into the wood blocking	

Finishes

FABRICS

A		WIDTH
Blueprint	Mayer	66"
Cipher	Mayer	66"
Code	Mayer	66"
Forte	Mayer	54"
Graph	Mayer	66"

B		WIDTH
Cross Check	Mayer	54"
Luminary	Mayer	66"
Quattro	Mayer	54"
Sprite	Guilford of Maine	66"
Strata	Mayer	66"
Tweed	Guilford of Maine	66"

C		WIDTH
Cape Cod	Guilford of Maine	66"
Infinity C-Zero	Momentum	57"
Marathon C-Zero	Momentum	57"
Metallation	Guilford of Maine	66"
Metro	Guilford of Maine	66"
Millennium C-Zero	Momentum	56"
Odyssey C-Zero	Momentum	56"
Rattan	Guilford of Maine	66"
Reverb	Mayer	54"
Tradition C-Zero	Momentum	56"

D		WIDTH
Fedora	Mayer	54"

E		WIDTH
Echo	Mayer	54"
Pact	Momentum	66"

LAMINATES

L1		
Casual Linen	SS-CLN	
Grey Mesh	SP-GRM	
Linen	SS-LN	
Mangalore Mango	SW-MGM	
Mission Maple	SW-MNM	
Nickle Ev	SS-NEV	
Organic Cotton	SS-OC	
Sterling Ash	SW-STA	

L2		
Asian Sand	PW-ASD	
Astro Strandz	PP-AST	
Biltmore Cherry	PW-BCH	
Cosmic Strandz	PP-CST	
Empire Mahogany	PW-EMH	
Fired Steel	PP-FIS	
Forged Steel	PP-FOS	
Shaker Cherry	PW-SCH	
Silver Alchemy	PW-SAL	
Studio Teak	PW-STK	
Vapor Strandz	PP-VST	

EDGE BANDS

Asian Sand	EB-ASD
Astro Strandz	EB-AST
Beige	EB-BEI
Biltmore Cherry	EB-BCH
Casual Linen	EB-CLN
Cosmic Strandz	EB-CST
Custom Laminate	EB-COL
Empire Mahogany	EB-EMH
Fashion Grey	EB-FGR
Fired Steel	EB-FIS
Forged Steel	EB-FOR
Grey	EB-GRY
Grey Mesh	EB-GRM
Khaki Brown	EB-BRN
Linen	EB-LN
Mangalore Mango	EB-MGM
Mission Maple	EB-MNM
Nickle Ev	EB-NEV
Organic Cotton	EB-OC
Pepperdust	EB-PPR
Platinum	EB-PLT
Sand	EB-SND
Shadow	EB-SHD
Shaker Cherry	EB-SCH
Silver Alchemy	EB-SAL
Slate Grey	EB-SGR
Soft Gold Mesh	EB-SGM
Sterling Ash	EB-STA
Studio Teak	EB-STK
Vapor Strandz	EB-VST
Virtual Design Laminate	EB-VL

NOTE: Laminates and other finishes may vary in color due to different dye lots. Slight variations are normal.

PAINTS

P1

Cream	201T
Designer Beige	202T
Grey	203T
Jet Black	204T
Sky White	200T

P2

Brass	303
Champagne	301
Platinum	302

PLEXIGLASS

Clear	CL
Ice	IC
Frost (<i>Not Available on Insert Panels</i>)	LF
Smoked	SM
Translucent	TR

GLASS

Clear	CL
Grey	GR
Smoked	SM
Translucent	TR

DESIGNER GLASS

Patterns from Skyline Design.
Some exceptions apply.

There is a minimum \$500 set-up and crating fee for all designer glass orders. Please call Customer Service for a quote 979.778.0502 ext 301.

CORIAN

Glacier White	CR001
Pearl Grey	CR002
Corian Clay	CR003
Silver Grey	CR004
Corian Grey	CR005

TEXTURED CORIAN

Glacier White	CR001T
Pearl Grey	CR002T
Corian Clay	CR003T
Silver Grey	CR004T
Corian Grey	CR005T

Custom Finishes Program

While Neutral Posture offers a large selection of unique finishes, we understand you might want to create a signature on your project or brand your project. We are offering an easy way for you to provide pricing to your client.

CUSTOMER'S OWN FABRIC

Neutral Posture can apply any UL fire rated fabric. This will add to the lead time as we will require three yards of fabric to test on a panel. Test yardage should be sent to the factory address in Bryan, TX with the project name clearly marked on the label noting test yardage.

Neutral Posture Test Fabric
Attention: Systems Product Manager
3904 N. Texas Ave.
Bryan, TX 77803

We can also grade-in any fabric from any supplier in the industry. Please contact Customer Service for grade-in pricing. Note that all grade-ins must be pre-approved for suitability before production begins.

CUSTOMER'S OWN LAMINATE

All of Neutral Posture's standard laminates are Wilsonart. For your project, you can select any Wilsonart laminate and use L1 for standard laminates, L2 for premium laminates and L3 for custom and virtual library programs. An upcharge may apply for matching edge banding. Please contact Customer Service for more information.

We can also grade-in any laminate from any other supplier. Please contact Customer Service for grade-in pricing. Note that all grade-ins must be pre-approved for suitability before production begins.

CUSTOM RAL PAINT FINISHES

Whether it is an 8 person or 1,000 person project, use any RAL powder coat color on your metal products. If you have any questions, please contact Customer Service for more information.

HOW TO PRICE

For Each Order

Setup fee per RAL color \$1,100 (NET)
Each item using an RAL color P3 Pricing

Legacy finishes are only available for existing customers to match existing installs

LEGACY – LAMINATES

L1

Bright White	118
Caramel Maple	MC
Clear Maple	CM
Deep Mahogany	MP58
Jet Black	111
Medium Cherry	124
Pearwood	PA
Pumice (was LF)	119
Warm Cherry	WM
White Essence	ES7
Winter Grey Matrix	MR6

NOTE: If your laminate is not listed please contact Customer Service at customerservice@neutralposture.com or 979.778.0502 ext. 301 to check availability.

LEGACY – EDGE BANDS

Bright White	118
Caramel Maple	MC
Clear Maple	CM
Jet Black	111
Medium Cherry	124
Pumice (was LF)	119

LEGACY – PAINTS & PLASTICS

P1

Jet Black	111
Brown	112
Dark Grey (was Y3)	113
Folkstone Grey (was LA)	114
Med. Grey (was Y2)	115
Sandstone	116
Soft Grey (was E)	117
Dark Neutral	D
Taupe	R

P2

Beige Mist Metallic	611
Medium Metallic Grey	612
Beige Metallic	H
Light Tan Metallic	W

P3

Bright White	118
Silver	613

NOTE: EP1 and EP2 panels and components are not available in the following:

Bright White	118
Brown	112
Jet Black	111

Panels

General Info

Step 1 – Model

EP	Equity Panel	3	Beveled	FA	Fabric Panel	36	29	K	Raceway
		N	Flat					N	with knockouts without knockouts
EP		N		FA		36	29	K	

Step 2 – Surface Finish

F298	Forte
F298	

Step 3 – Trim Finish

301	Champagne
301	

FEATURES

HEIGHTS

29" H
36" H
41" H
49" H
54" H
61" H
66" H
81" H

WIDTHS

12" W
18" W
24" W
30" W
36" W
42" W
48" W
60" W

THICKNESS

1 1/2"

TOP CAP

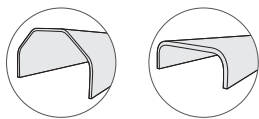

3 – Beveled

N – Flat

RACEWAY

(K) with knockouts
(N) without knockouts

PANEL RATINGS

NRC	.75
STC	15

CONSTRUCTION

FABRIC PANEL FRAME

Galvaneal roll formed steel frame

FABRIC PANEL CORE

Mineral wool
Fiberglass backer

INSERT PANEL FRAME

Extruded aluminum

INSERT PANEL CORE

1/4" Laminate
1/4" Perforated aluminum
1/4" Plexiglass
Open Frame

TOP CAP, SLOTTED STANDARD

Cold rolled, roll formed steel

TOP CAP CLIP

Spring steel

RACEWAY COVER, RACEWAY BASE & RACEWAY RETENTION CHANNEL

Cold rolled, roll formed steel

RACEWAY STANCHIONS

Pressed & folded steel

PANEL HOOKS

Steel

POSTS

Steel tube

POST CONNECTORS

Diecast aluminum

SHROUDS

Pressed & folded steel

SURFACE MATERIALS

ALL PANELS

Trim – paint

FABRIC PANELS (FA)

Fabric

INSERT PANELS

Plexiglass (PG)

Clear	CL
Ice	IC
Smoked	SM
Translucent	TR

Glass (GL)

Clear	CL
Grey	GR
Smoked	SM
Translucent	TR

Designer Glass (DG)

Patterns from Skyline Design.
Some exceptions apply.

There is a minimum \$500 set-up and crating fee for all designer glass orders. Please call customer service for a quote 979.778.0502 ext 301.

Laminate (LM)

Laminate

Perforated Aluminum (PA)

Paint

Open Frame (OF)

Paint

POSTS, CONNECTORS & SHROUDS

Paint

PANELS

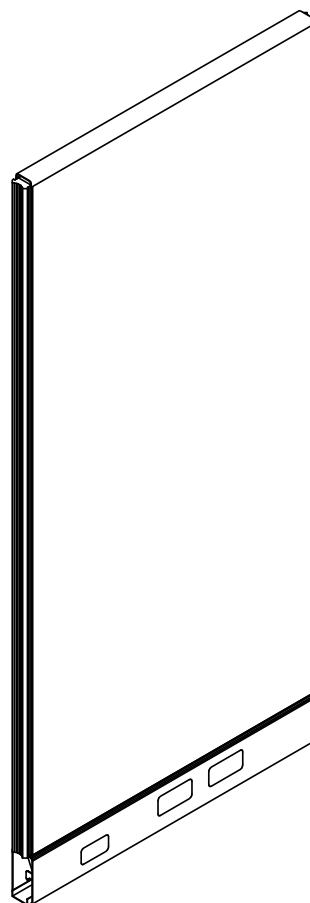

Fabric Panels

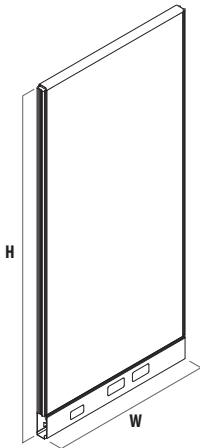

29" H

W	MODEL #	FABRIC								PAINT	
		A	B	C	D	E	F	G	H	P2	P3
12"	EP(3/N)FA1229(K/N)	\$519	\$549	\$589	\$639	\$699	\$769	\$849	\$939	+ \$30	+ \$60
18"	EP(3/N)FA1829(K/N)	\$580	\$610	\$650	\$700	\$760	\$830	\$910	\$1,000	+ \$30	+ \$60
24"	EP(3/N)FA2429(K/N)	\$639	\$669	\$709	\$759	\$819	\$889	\$969	\$1,059	+ \$30	+ \$60
30"	EP(3/N)FA3029(K/N)	\$700	\$730	\$770	\$820	\$880	\$950	\$1,030	\$1,120	+ \$30	+ \$60
36"	EP(3/N)FA3629(K/N)	\$784	\$844	\$924	\$1,024	\$1,144	\$1,284	\$1,444	\$1,624	+ \$30	+ \$60
42"	EP(3/N)FA4229(K/N)	\$833	\$893	\$973	\$1,073	\$1,193	\$1,333	\$1,493	\$1,673	+ \$30	+ \$60
48"	EP(3/N)FA4829(K/N)	\$881	\$941	\$1,021	\$1,121	\$1,241	\$1,381	\$1,541	\$1,721	+ \$30	+ \$60
60"	EP(3/N)FA6029(K/N)	\$929	\$989	\$1,069	\$1,169	\$1,289	\$1,429	\$1,589	\$1,769	+ \$30	+ \$60

41" H

12"	EP(3/N)FA1241(K/N)	\$580	\$620	\$670	\$730	\$810	\$900	\$1,010	\$1,140	+ \$30	+ \$60
18"	EP(3/N)FA1841(K/N)	\$639	\$679	\$729	\$789	\$869	\$959	\$1,069	\$1,199	+ \$30	+ \$60
24"	EP(3/N)FA2441(K/N)	\$700	\$740	\$790	\$850	\$930	\$1,020	\$1,130	\$1,260	+ \$30	+ \$60
30"	EP(3/N)FA3041(K/N)	\$760	\$800	\$850	\$910	\$990	\$1,080	\$1,190	\$1,320	+ \$30	+ \$60
36"	EP(3/N)FA3641(K/N)	\$845	\$925	\$1,025	\$1,145	\$1,305	\$1,495	\$1,735	\$2,025	+ \$30	+ \$60
42"	EP(3/N)FA4241(K/N)	\$905	\$985	\$1,085	\$1,205	\$1,365	\$1,555	\$1,795	\$2,085	+ \$30	+ \$60
48"	EP(3/N)FA4841(K/N)	\$966	\$1,046	\$1,146	\$1,266	\$1,426	\$1,616	\$1,856	\$2,146	+ \$30	+ \$60
60"	EP(3/N)FA6041(K/N)	\$1,026	\$1,106	\$1,206	\$1,326	\$1,486	\$1,676	\$1,916	\$2,206	+ \$30	+ \$60

49" H

12"	EP(3/N)FA1249(K/N)	\$652	\$692	\$742	\$802	\$882	\$982	\$1,102	\$1,252	+ \$30	+ \$60
18"	EP(3/N)FA1849(K/N)	\$712	\$752	\$802	\$862	\$942	\$1,042	\$1,162	\$1,312	+ \$30	+ \$60
24"	EP(3/N)FA2449(K/N)	\$773	\$813	\$863	\$923	\$1,003	\$1,103	\$1,223	\$1,373	+ \$30	+ \$60
30"	EP(3/N)FA3049(K/N)	\$833	\$873	\$923	\$983	\$1,063	\$1,163	\$1,283	\$1,433	+ \$30	+ \$60
36"	EP(3/N)FA3649(K/N)	\$918	\$998	\$1,098	\$1,218	\$1,388	\$1,598	\$1,868	\$2,188	+ \$30	+ \$60
42"	EP(3/N)FA4249(K/N)	\$978	\$1,058	\$1,158	\$1,278	\$1,448	\$1,658	\$1,928	\$2,248	+ \$30	+ \$60
48"	EP(3/N)FA4849(K/N)	\$1,038	\$1,118	\$1,218	\$1,338	\$1,508	\$1,718	\$1,988	\$2,308	+ \$30	+ \$60
60"	EP(3/N)FA6049(K/N)	\$1,122	\$1,202	\$1,302	\$1,422	\$1,592	\$1,802	\$2,072	\$2,392	+ \$30	+ \$60

54" H

12"	EP(3/N)FA1254(K/N)	\$712	\$752	\$802	\$872	\$972	\$1,082	\$1,212	\$1,372	+ \$30	+ \$60
18"	EP(3/N)FA1854(K/N)	\$773	\$813	\$863	\$933	\$1,033	\$1,143	\$1,273	\$1,433	+ \$30	+ \$60
24"	EP(3/N)FA2454(K/N)	\$833	\$873	\$923	\$993	\$1,093	\$1,203	\$1,333	\$1,493	+ \$30	+ \$60
30"	EP(3/N)FA3054(K/N)	\$894	\$934	\$984	\$1,054	\$1,154	\$1,264	\$1,394	\$1,554	+ \$30	+ \$60
36"	EP(3/N)FA3654(K/N)	\$990	\$1,080	\$1,180	\$1,320	\$1,530	\$1,760	\$2,030	\$2,360	+ \$30	+ \$60
42"	EP(3/N)FA4254(K/N)	\$1,050	\$1,140	\$1,240	\$1,380	\$1,590	\$1,820	\$2,090	\$2,420	+ \$30	+ \$60
48"	EP(3/N)FA4854(K/N)	\$1,111	\$1,201	\$1,301	\$1,441	\$1,651	\$1,881	\$2,151	\$2,481	+ \$30	+ \$60
60"	EP(3/N)FA6054(K/N)	\$1,195	\$1,285	\$1,385	\$1,525	\$1,735	\$1,965	\$2,235	\$2,565	+ \$30	+ \$60

Specify

1. Model #
2. Fabric
3. Paint

Application Notes

The panel is fabric covered. If two different fabrics are used on one panel, the price will reflect the cost of the most expensive panel fabric.

NOTE: Power duplexes cannot be installed on 12" W panels. Side mount receptacles available on 24" W panels and wider.

Assembly

- Included**
- Panel
 - Top cap
 - Metal raceway covers

Ordered Separately

- Posts
- Panel connectors
- Electrical components

Top Cap Styles

3 – Beveled

N – Flat

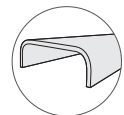
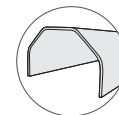

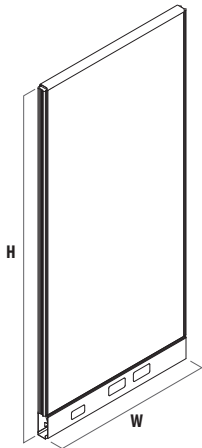

61" H

W	MODEL #	FABRIC								PAINT	
		A	B	C	D	E	F	G	H	P2	P3
12"	EP(3/N)FA1261(K/N)	\$773	\$823	\$883	\$963	\$1,073	\$1,193	\$1,333	\$1,503	+ \$30	+ \$60
18"	EP(3/N)FA1861(K/N)	\$833	\$883	\$943	\$1,023	\$1,133	\$1,253	\$1,393	\$1,563	+ \$30	+ \$60
24"	EP(3/N)FA2461(K/N)	\$894	\$944	\$1,004	\$1,084	\$1,194	\$1,314	\$1,454	\$1,624	+ \$30	+ \$60
30"	EP(3/N)FA3061(K/N)	\$953	\$1,003	\$1,063	\$1,143	\$1,253	\$1,373	\$1,513	\$1,683	+ \$30	+ \$60
36"	EP(3/N)FA3661(K/N)	\$1,038	\$1,138	\$1,258	\$1,418	\$1,648	\$1,898	\$2,178	\$2,518	+ \$30	+ \$60
42"	EP(3/N)FA4261(K/N)	\$1,098	\$1,198	\$1,318	\$1,478	\$1,708	\$1,958	\$2,238	\$2,578	+ \$30	+ \$60
48"	EP(3/N)FA4861(K/N)	\$1,159	\$1,259	\$1,379	\$1,539	\$1,769	\$2,019	\$2,299	\$2,639	+ \$30	+ \$60
60"	EP(3/N)FA6061(K/N)	\$1,267	\$1,367	\$1,487	\$1,647	\$1,877	\$2,127	\$2,407	\$2,747	+ \$30	+ \$60

66" H

12"	EP(3/N)FA1266(K/N)	\$797	\$847	\$907	\$987	\$1,107	\$1,237	\$1,387	\$1,567	+ \$30	+ \$60
18"	EP(3/N)FA1866(K/N)	\$857	\$907	\$967	\$1,047	\$1,167	\$1,297	\$1,447	\$1,627	+ \$30	+ \$60
24"	EP(3/N)FA2466(K/N)	\$918	\$968	\$1,028	\$1,108	\$1,228	\$1,358	\$1,508	\$1,688	+ \$30	+ \$60
30"	EP(3/N)FA3066(K/N)	\$978	\$1,028	\$1,088	\$1,168	\$1,288	\$1,418	\$1,568	\$1,748	+ \$30	+ \$60
36"	EP(3/N)FA3666(K/N)	\$1,074	\$1,184	\$1,314	\$1,474	\$1,724	\$2,004	\$2,324	\$2,714	+ \$30	+ \$60
42"	EP(3/N)FA4266(K/N)	\$1,135	\$1,245	\$1,375	\$1,535	\$1,785	\$2,065	\$2,385	\$2,775	+ \$30	+ \$60
48"	EP(3/N)FA4866(K/N)	\$1,195	\$1,305	\$1,435	\$1,595	\$1,845	\$2,125	\$2,445	\$2,835	+ \$30	+ \$60
60"	EP(3/N)FA6066(K/N)	\$1,304	\$1,414	\$1,544	\$1,704	\$1,954	\$2,234	\$2,554	\$2,944	+ \$30	+ \$60

81" H

12"	EP(3/N)FA1281(K/N)	\$857	\$917	\$977	\$1,067	\$1,217	\$1,387	\$1,577	\$1,797	+ \$30	+ \$60
18"	EP(3/N)FA1881(K/N)	\$918	\$978	\$1,038	\$1,128	\$1,278	\$1,448	\$1,638	\$1,858	+ \$30	+ \$60
24"	EP(3/N)FA2481(K/N)	\$978	\$1,038	\$1,098	\$1,188	\$1,338	\$1,508	\$1,698	\$1,918	+ \$30	+ \$60
30"	EP(3/N)FA3081(K/N)	\$1,038	\$1,098	\$1,158	\$1,248	\$1,398	\$1,568	\$1,758	\$1,978	+ \$30	+ \$60
36"	EP(3/N)FA3681(K/N)	\$1,256	\$1,376	\$1,496	\$1,686	\$2,016	\$2,386	\$2,796	\$3,256	+ \$30	+ \$60
42"	EP(3/N)FA4281(K/N)	\$1,401	\$1,521	\$1,641	\$1,831	\$2,161	\$2,531	\$2,941	\$3,401	+ \$30	+ \$60
48"	EP(3/N)FA4881(K/N)	\$1,509	\$1,629	\$1,749	\$1,939	\$2,269	\$2,639	\$3,049	\$3,509	+ \$30	+ \$60
60"	EP(3/N)FA6081(K/N)	\$1,618	\$1,738	\$1,858	\$2,048	\$2,378	\$2,748	\$3,158	\$3,618	+ \$30	+ \$60

Guardian® Panel Option

BULLET RESISTANT PANEL

- NIJ Level IIIA compliant
- Protection against handguns up to .44 Magnum
- Inconspicuous – looks like a regular panel

UPCHARGE (NET)

WIDTH	HEIGHT						
	29"	41"	49"	54"	61"	66"	81"
30"	\$263	\$380	\$444	\$488	\$552	\$597	\$733
36"	\$315	\$456	\$532	\$586	\$663	\$717	\$880
42"	\$368	\$532	\$622	\$685	\$774	\$836	\$1,026
48"	\$420	\$608	\$710	\$782	\$883	\$956	\$1,173

NOTE: To specify a Guardian Panel add a "G" to the end of the panels model number.

Pricing is for P1 paint colors. Add the appropriate upcharge if using P2 or P3 trim.

Insert Panels

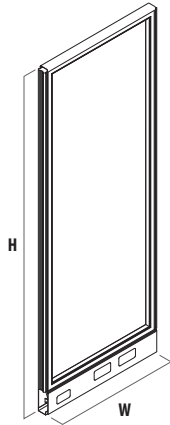

29" H

W	MODEL #	OF	GLASS INSERT			LAMINATE INSERT			PAINT	
			PG	GL	DG	L1	L2	L3	P2	P3
12"	EP(3/N)()1229(K/N)	\$841	\$1,023	\$1,131	\$1,324	\$1,083	\$1,191	\$1,300	+ \$30	+ \$60
18"	EP(3/N)()1829(K/N)	\$854	\$1,047	\$1,168	\$1,445	\$1,143	\$1,257	\$1,372	+ \$30	+ \$60
24"	EP(3/N)()2429(K/N)	\$865	\$1,071	\$1,203	\$1,566	\$1,179	\$1,297	\$1,415	+ \$30	+ \$60
30"	EP(3/N)()3029(K/N)	\$889	\$1,107	\$1,252	\$1,686	\$1,216	\$1,338	\$1,459	+ \$30	+ \$60
36"	EP(3/N)()3629(K/N)	\$914	\$1,155	\$1,313	\$1,796	\$1,276	\$1,404	\$1,531	+ \$30	+ \$60
42"	EP(3/N)()4229(K/N)	\$938	\$1,216	\$1,372	\$1,916	\$1,337	\$1,471	\$1,604	+ \$30	+ \$60
48"	EP(3/N)()4829(K/N)	\$962	\$1,288	\$1,445	\$2,049	\$1,409	\$1,550	\$1,691	+ \$30	+ \$60
60"	EP(3/N)()6029(K/N)	\$1,010	\$1,372	\$1,530	\$2,254	\$1,493	\$1,642	\$1,792	+ \$30	+ \$60

41" H

12"	EP(3/N)()1241(K/N)	\$889	\$1,143	\$1,276	\$1,493	\$1,143	\$1,257	\$1,372	+ \$30	+ \$60
18"	EP(3/N)()1841(K/N)	\$902	\$1,168	\$1,300	\$1,602	\$1,264	\$1,390	\$1,517	+ \$30	+ \$60
24"	EP(3/N)()2441(K/N)	\$914	\$1,203	\$1,348	\$1,735	\$1,313	\$1,444	\$1,576	+ \$30	+ \$60
30"	EP(3/N)()3041(K/N)	\$938	\$1,252	\$1,409	\$1,892	\$1,372	\$1,509	\$1,646	+ \$30	+ \$60
36"	EP(3/N)()3641(K/N)	\$962	\$1,313	\$1,469	\$2,013	\$1,433	\$1,576	\$1,720	+ \$30	+ \$60
42"	EP(3/N)()4241(K/N)	\$986	\$1,385	\$1,541	\$2,145	\$1,506	\$1,657	\$1,807	+ \$30	+ \$60
48"	EP(3/N)()4841(K/N)	\$1,010	\$1,469	\$1,638	\$2,363	\$1,602	\$1,762	\$1,922	+ \$30	+ \$60
60"	EP(3/N)()6041(K/N)	\$1,058	\$1,566	\$1,747	\$2,713	\$1,710	\$1,881	\$2,052	+ \$30	+ \$60

49" H

12"	EP(3/N)()1249(K/N)	\$902	\$1,168	\$1,300	\$1,517	\$1,203	\$1,323	\$1,444	+ \$30	+ \$60
18"	EP(3/N)()1849(K/N)	\$914	\$1,203	\$1,337	\$1,638	\$1,300	\$1,430	\$1,560	+ \$30	+ \$60
24"	EP(3/N)()2449(K/N)	\$926	\$1,252	\$1,397	\$1,783	\$1,361	\$1,497	\$1,633	+ \$30	+ \$60
30"	EP(3/N)()3049(K/N)	\$950	\$1,313	\$1,469	\$1,976	\$1,433	\$1,576	\$1,720	+ \$30	+ \$60
36"	EP(3/N)()3649(K/N)	\$974	\$1,385	\$1,541	\$2,169	\$1,506	\$1,657	\$1,807	+ \$30	+ \$60
42"	EP(3/N)()4249(K/N)	\$999	\$1,469	\$1,626	\$2,375	\$1,590	\$1,749	\$1,908	+ \$30	+ \$60
48"	EP(3/N)()4849(K/N)	\$1,023	\$1,566	\$1,723	\$2,592	\$1,686	\$1,855	\$2,023	+ \$30	+ \$60
60"	EP(3/N)()6049(K/N)	\$1,071	\$1,699	\$1,880	\$2,870	\$1,844	\$2,028	\$2,213	+ \$30	+ \$60

54" H

12"	EP(3/N)()1254(K/N)	\$938	\$1,179	\$1,313	\$1,530	\$1,264	\$1,390	\$1,517	+ \$30	+ \$60
18"	EP(3/N)()1854(K/N)	\$950	\$1,227	\$1,361	\$1,662	\$1,324	\$1,456	\$1,589	+ \$30	+ \$60
24"	EP(3/N)()2454(K/N)	\$962	\$1,288	\$1,433	\$1,820	\$1,397	\$1,537	\$1,676	+ \$30	+ \$60
30"	EP(3/N)()3054(K/N)	\$986	\$1,361	\$1,517	\$2,024	\$1,482	\$1,630	\$1,778	+ \$30	+ \$60
36"	EP(3/N)()3654(K/N)	\$1,010	\$1,445	\$1,602	\$2,230	\$1,566	\$1,723	\$1,879	+ \$30	+ \$60
42"	EP(3/N)()4254(K/N)	\$1,034	\$1,541	\$1,699	\$2,448	\$1,662	\$1,828	\$1,994	+ \$30	+ \$60
48"	EP(3/N)()4854(K/N)	\$1,058	\$1,651	\$1,820	\$2,689	\$1,783	\$1,961	\$2,140	+ \$30	+ \$60
60"	EP(3/N)()6054(K/N)	\$1,107	\$1,783	\$1,965	\$2,955	\$1,928	\$2,121	\$2,314	+ \$30	+ \$60

Specify

1. Model #
2. Insert type
3. Insert color
4. Paint

NOTE: Power duplexes cannot be installed on 12" W panels. Side mount receptacles available on 24" W panels and wider.

Plexiglass Finishes

- CL .. Clear
 IC ... Ice
 SM .. Smoked
 TR .. Translucent

Glass Finishes

- CL .. Clear
 GR .. Grey
 SM .. Smoked
 TR .. Translucent

Application Notes

Insert Panels are constructed with a tapered aluminum frame that is mitered in the corners. Insert panels may be ordered with multiple insert options or as an open frame for complete accessibility through the panel.

Assembly

- Included**
- Panel
 - Top cap
 - Metal raceway covers

Ordered Separately

- Posts
- Panel connectors
- Electrical components

Top Cap Styles

3 – Beveled

N – Flat

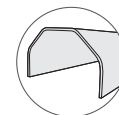

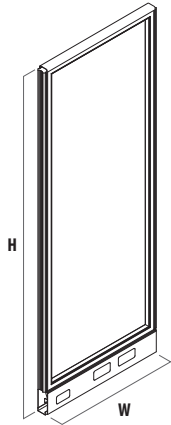

61" H

W	MODEL #	OF	GLASS INSERT			LAMINATE INSERT			PAINT	
			PG	GL	DG	L1	L2	L3	P2	P3
12"	EP(3/N)()1261(K/N)	\$950	\$1,192	\$1,337	\$1,578	\$1,288	\$1,417	\$1,546	+ \$30	+ \$60
18"	EP(3/N)()1861(K/N)	\$962	\$1,252	\$1,397	\$1,699	\$1,348	\$1,483	\$1,618	+ \$30	+ \$60
24"	EP(3/N)()2461(K/N)	\$974	\$1,324	\$1,482	\$1,880	\$1,433	\$1,576	\$1,720	+ \$30	+ \$60
30"	EP(3/N)()3061(K/N)	\$999	\$1,409	\$1,578	\$2,097	\$1,530	\$1,683	\$1,836	+ \$30	+ \$60
36"	EP(3/N)()3661(K/N)	\$1,023	\$1,506	\$1,675	\$2,314	\$1,626	\$1,789	\$1,951	+ \$30	+ \$60
42"	EP(3/N)()4261(K/N)	\$1,047	\$1,614	\$1,796	\$2,556	\$1,747	\$1,922	\$2,096	+ \$30	+ \$60
48"	EP(3/N)()4861(K/N)	\$1,071	\$1,735	\$1,928	\$2,810	\$1,880	\$2,068	\$2,256	+ \$30	+ \$60
60"	EP(3/N)()6061(K/N)	\$1,131	\$1,868	\$2,073	\$3,208	\$2,024	\$2,226	\$2,429	+ \$30	+ \$60

66" H

12"	EP(3/N)()1266(K/N)	\$962	\$1,203	\$1,348	\$1,590	\$1,300	\$1,430	\$1,560	+ \$30	+ \$60
18"	EP(3/N)()1866(K/N)	\$974	\$1,276	\$1,421	\$1,747	\$1,372	\$1,509	\$1,646	+ \$30	+ \$60
24"	EP(3/N)()2466(K/N)	\$986	\$1,361	\$1,517	\$1,940	\$1,469	\$1,616	\$1,763	+ \$30	+ \$60
30"	EP(3/N)()3066(K/N)	\$1,010	\$1,457	\$1,626	\$2,169	\$1,578	\$1,736	\$1,894	+ \$30	+ \$60
36"	EP(3/N)()3666(K/N)	\$1,034	\$1,566	\$1,735	\$2,399	\$1,686	\$1,855	\$2,023	+ \$30	+ \$60
42"	EP(3/N)()4266(K/N)	\$1,058	\$1,686	\$1,868	\$2,652	\$1,820	\$2,002	\$2,184	+ \$30	+ \$60
48"	EP(3/N)()4866(K/N)	\$1,083	\$1,820	\$2,013	\$2,918	\$1,965	\$2,162	\$2,358	+ \$30	+ \$60
60"	EP(3/N)()6066(K/N)	\$1,143	\$1,965	\$2,158	\$3,304	\$2,109	\$2,320	\$2,531	+ \$30	+ \$60

81" H

12"	EP(3/N)()1281(K/N)	\$1,034	\$1,433	\$1,602	\$1,868	\$1,554	\$1,709	\$1,865	+ \$30	+ \$60
18"	EP(3/N)()1881(K/N)	\$1,047	\$1,554	\$1,723	\$2,085	\$1,675	\$1,843	\$2,010	+ \$30	+ \$60
24"	EP(3/N)()2481(K/N)	\$1,058	\$1,675	\$1,844	\$2,327	\$1,796	\$1,976	\$2,155	+ \$30	+ \$60
30"	EP(3/N)()3081(K/N)	\$1,083	\$1,796	\$1,965	\$2,568	\$1,916	\$2,108	\$2,299	+ \$30	+ \$60
36"	EP(3/N)()3681(K/N)	\$1,107	\$1,916	\$2,085	\$2,810	\$2,037	\$2,241	\$2,444	+ \$30	+ \$60
42"	EP(3/N)()4281(K/N)	\$1,131	\$2,037	\$2,206	\$3,051	\$2,158	\$2,374	\$2,590	+ \$30	+ \$60
48"	EP(3/N)()4881(K/N)	\$1,155	\$2,182	\$2,351	\$3,317	\$2,303	\$2,533	\$2,764	+ \$30	+ \$60
60"	EP(3/N)()6081(K/N)	\$1,240	\$2,363	\$2,532	\$4,041	\$2,483	\$2,731	\$2,980	+ \$30	+ \$60

		Top Cap	Panel Type	W	H	Raceway
EP	Equity Panel	3 Beveled N Flat	OF Open frame DG Designer glass insert GL Glass insert PG Plexiglass insert LM Laminate insert	36	29	K With knockouts N Without knockouts
EP		N	PG	36	29	K

Insert Panels

Perforated Aluminum

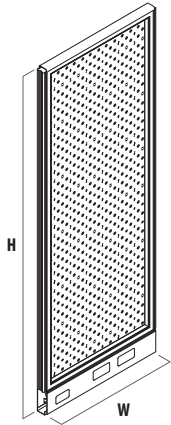

29" H

W	MODEL #	PA	INSERT PAINT			FRAME PAINT	
			P1	P2	P3	P2	P3
12"	EP(3/N)PA1229(K/N)	\$962	\$1,012	\$1,022	\$1,032	+ \$30	+ \$60
18"	EP(3/N)PA1829(K/N)	\$974	\$1,034	\$1,054	\$1,074	+ \$30	+ \$60
24"	EP(3/N)PA2429(K/N)	\$999	\$1,059	\$1,089	\$1,119	+ \$30	+ \$60
30"	EP(3/N)PA3029(K/N)	\$1,034	\$1,094	\$1,124	\$1,164	+ \$30	+ \$60
36"	EP(3/N)PA3629(K/N)	\$1,083	\$1,143	\$1,173	\$1,213	+ \$30	+ \$60
42"	EP(3/N)PA4229(K/N)	\$1,131	\$1,201	\$1,241	\$1,281	+ \$30	+ \$60
48"	EP(3/N)PA4829(K/N)	\$1,203	\$1,273	\$1,323	\$1,373	+ \$30	+ \$60
60"	EP(3/N)PA6029(K/N)	\$1,288	\$1,358	\$1,418	\$1,478	+ \$30	+ \$60

41" H

12"	EP(3/N)PA1241(K/N)	\$1,058	\$1,128	\$1,148	\$1,168	+ \$30	+ \$60
18"	EP(3/N)PA1841(K/N)	\$1,083	\$1,153	\$1,173	\$1,203	+ \$30	+ \$60
24"	EP(3/N)PA2441(K/N)	\$1,119	\$1,189	\$1,219	\$1,259	+ \$30	+ \$60
30"	EP(3/N)PA3041(K/N)	\$1,168	\$1,238	\$1,278	\$1,328	+ \$30	+ \$60
36"	EP(3/N)PA3641(K/N)	\$1,227	\$1,297	\$1,347	\$1,407	+ \$30	+ \$60
42"	EP(3/N)PA4241(K/N)	\$1,288	\$1,368	\$1,428	\$1,498	+ \$30	+ \$60
48"	EP(3/N)PA4841(K/N)	\$1,372	\$1,452	\$1,532	\$1,602	+ \$30	+ \$60
60"	EP(3/N)PA6041(K/N)	\$1,469	\$1,549	\$1,649	\$1,739	+ \$30	+ \$60

49" H

12"	EP(3/N)PA1249(K/N)	\$1,083	\$1,153	\$1,173	\$1,193	+ \$30	+ \$60
18"	EP(3/N)PA1849(K/N)	\$1,119	\$1,189	\$1,219	\$1,249	+ \$30	+ \$60
24"	EP(3/N)PA2449(K/N)	\$1,168	\$1,238	\$1,288	\$1,328	+ \$30	+ \$60
30"	EP(3/N)PA3049(K/N)	\$1,227	\$1,297	\$1,357	\$1,407	+ \$30	+ \$60
36"	EP(3/N)PA3649(K/N)	\$1,288	\$1,368	\$1,438	\$1,508	+ \$30	+ \$60
42"	EP(3/N)PA4249(K/N)	\$1,372	\$1,452	\$1,532	\$1,622	+ \$30	+ \$60
48"	EP(3/N)PA4849(K/N)	\$1,469	\$1,549	\$1,649	\$1,749	+ \$30	+ \$60
60"	EP(3/N)PA6049(K/N)	\$1,602	\$1,682	\$1,802	\$1,912	+ \$30	+ \$60

54" H

12"	EP(3/N)PA1254(K/N)	\$1,095	\$1,165	\$1,185	\$1,205	+ \$30	+ \$60
18"	EP(3/N)PA1854(K/N)	\$1,143	\$1,213	\$1,243	\$1,273	+ \$30	+ \$60
24"	EP(3/N)PA2454(K/N)	\$1,203	\$1,273	\$1,323	\$1,373	+ \$30	+ \$60
30"	EP(3/N)PA3054(K/N)	\$1,264	\$1,344	\$1,404	\$1,464	+ \$30	+ \$60
36"	EP(3/N)PA3654(K/N)	\$1,348	\$1,428	\$1,508	\$1,588	+ \$30	+ \$60
42"	EP(3/N)PA4254(K/N)	\$1,445	\$1,525	\$1,615	\$1,705	+ \$30	+ \$60
48"	EP(3/N)PA4854(K/N)	\$1,554	\$1,634	\$1,734	\$1,834	+ \$30	+ \$60
60"	EP(3/N)PA6054(K/N)	\$1,686	\$1,766	\$1,896	\$2,026	+ \$30	+ \$60

Specify

1. Model #
2. Insert paint
3. Paint

NOTE: Power duplexes cannot be installed on 12" W panels. Side mount receptacles available on 24" W panels and wider.

Application Notes

Insert Panels are constructed with a tapered aluminum frame that is mitered in the corners. Insert panels may be ordered multiple insert options or as an open frame for complete accessibility through the panel.

Assembly

- Included**
- Panel
 - Top cap
 - Metal raceway covers

Ordered Separately

- Posts
- Panel connectors
- Electrical components

Top Cap Styles

3 – Beveled

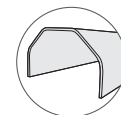

N – Flat

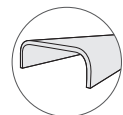

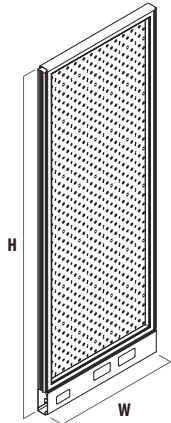

61" H

W	MODEL #	PA	INSERT PAINT			FRAME PAINT	
			P1	P2	P3	P2	P3
12"	EP(3/N)PA1261(K/N)	\$1,107	\$1,177	\$1,197	\$1,227	+ \$30	+ \$60
18"	EP(3/N)PA1861(K/N)	\$1,168	\$1,238	\$1,278	\$1,318	+ \$30	+ \$60
24"	EP(3/N)PA2461(K/N)	\$1,227	\$1,307	\$1,357	\$1,407	+ \$30	+ \$60
30"	EP(3/N)PA3061(K/N)	\$1,313	\$1,393	\$1,453	\$1,523	+ \$30	+ \$60
36"	EP(3/N)PA3661(K/N)	\$1,409	\$1,489	\$1,569	\$1,649	+ \$30	+ \$60
42"	EP(3/N)PA4261(K/N)	\$1,517	\$1,597	\$1,687	\$1,787	+ \$30	+ \$60
48"	EP(3/N)PA4861(K/N)	\$1,638	\$1,718	\$1,818	\$1,938	+ \$30	+ \$60
60"	EP(3/N)PA6061(K/N)	\$2,037	\$2,097	\$2,217	\$2,357	+ \$30	+ \$60

66" H

12"	EP(3/N)PA1266(K/N)	\$1,119	\$1,189	\$1,219	\$1,249	+ \$30	+ \$60
18"	EP(3/N)PA1866(K/N)	\$1,192	\$1,262	\$1,302	\$1,352	+ \$30	+ \$60
24"	EP(3/N)PA2466(K/N)	\$1,264	\$1,344	\$1,394	\$1,454	+ \$30	+ \$60
30"	EP(3/N)PA3066(K/N)	\$1,361	\$1,441	\$1,511	\$1,581	+ \$30	+ \$60
36"	EP(3/N)PA3666(K/N)	\$1,469	\$1,549	\$1,639	\$1,729	+ \$30	+ \$60
42"	EP(3/N)PA4266(K/N)	\$1,578	\$1,668	\$1,768	\$1,868	+ \$30	+ \$60
48"	EP(3/N)PA4866(K/N)	\$1,686	\$1,796	\$1,916	\$2,036	+ \$30	+ \$60
60"	EP(3/N)PA6066(K/N)	\$2,061	\$2,231	\$2,361	\$2,511	+ \$30	+ \$60

81" H

12"	EP(3/N)PA1281(K/N)	\$1,313	\$1,413	\$1,453	\$1,503	+ \$30	+ \$60
18"	EP(3/N)PA1881(K/N)	\$1,433	\$1,533	\$1,593	\$1,673	+ \$30	+ \$60
24"	EP(3/N)PA2481(K/N)	\$1,554	\$1,654	\$1,734	\$1,834	+ \$30	+ \$60
30"	EP(3/N)PA3081(K/N)	\$1,796	\$1,896	\$1,996	\$2,116	+ \$30	+ \$60
36"	EP(3/N)PA3681(K/N)	\$1,916	\$2,016	\$2,136	\$2,276	+ \$30	+ \$60
42"	EP(3/N)PA4281(K/N)	\$1,989	\$2,089	\$2,249	\$2,399	+ \$30	+ \$60
48"	EP(3/N)PA4881(K/N)	\$2,049	\$2,149	\$2,359	\$2,519	+ \$30	+ \$60
60"	EP(3/N)PA6081(K/N)	\$2,652	\$2,852	\$3,102	\$3,302	+ \$30	+ \$60

		Top Cap	Panel Type	W	H	Raceway
EP	Equity Panel	3 Beveled N Flat	PA Perforated Aluminum	36	29	K With knockouts N Without knockouts
EP		N	PA	36	29	K

Tequity™ Panels

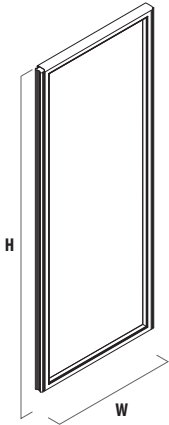

29" H

W	MODEL #	PAINT		
		P1	P2	P3
12"	EP(3/N)TQ1229	\$398	\$448	\$473
18"	EP(3/N)TQ1829	\$459	\$509	\$534
24"	EP(3/N)TQ2429	\$519	\$569	\$594
30"	EP(3/N)TQ3029	\$580	\$630	\$655
36"	EP(3/N)TQ3629	\$664	\$714	\$739
42"	EP(3/N)TQ4229	\$712	\$762	\$787
48"	EP(3/N)TQ4829	\$760	\$810	\$835
60"	EP(3/N)TQ6029	\$809	\$859	\$884

41" H

12"	EP(3/N)TQ1241	\$459	\$509	\$534
18"	EP(3/N)TQ1841	\$519	\$569	\$594
24"	EP(3/N)TQ2441	\$580	\$630	\$655
30"	EP(3/N)TQ3041	\$639	\$689	\$714
36"	EP(3/N)TQ3641	\$725	\$775	\$800
42"	EP(3/N)TQ4241	\$784	\$834	\$859
48"	EP(3/N)TQ4841	\$845	\$895	\$920
60"	EP(3/N)TQ6041	\$905	\$955	\$980

49" H

12"	EP(3/N)TQ1249	\$531	\$581	\$606
18"	EP(3/N)TQ1849	\$591	\$641	\$666
24"	EP(3/N)TQ2449	\$652	\$702	\$727
30"	EP(3/N)TQ3049	\$712	\$762	\$787
36"	EP(3/N)TQ3649	\$797	\$847	\$872
42"	EP(3/N)TQ4249	\$857	\$907	\$932
48"	EP(3/N)TQ4849	\$918	\$968	\$993
60"	EP(3/N)TQ6049	\$1,002	\$1,052	\$1,077

54" H

12"	EP(3/N)TQ1254	\$591	\$641	\$666
18"	EP(3/N)TQ1854	\$652	\$702	\$727
24"	EP(3/N)TQ2454	\$712	\$762	\$787
30"	EP(3/N)TQ3054	\$773	\$823	\$848
36"	EP(3/N)TQ3654	\$869	\$919	\$944
42"	EP(3/N)TQ4254	\$929	\$979	\$1,004
48"	EP(3/N)TQ4854	\$990	\$1,040	\$1,065
60"	EP(3/N)TQ6054	\$1,074	\$1,124	\$1,149

Specify

1. Model #
2. Paint

Application Notes

Tequity panels are constructed with a 16 gauge welded steel frame.

Worksurface Support w/Tequity Panels

When specifying worksurfaces use panel to worksurface brackets to support each corner.

Assembly

Included

- Panel
- Top cap

Ordered Separately

- Posts
- Panel connectors

Top Cap Styles

3 – Beveled

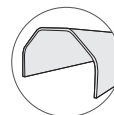

N – Flat

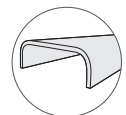

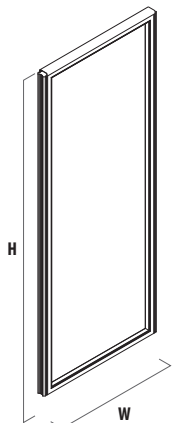

61" H

W	MODEL #	PAINT		
		P1	P2	P3
12"	EP(3/N)TQ1261	\$652	\$702	\$727
18"	EP(3/N)TQ1861	\$712	\$762	\$787
24"	EP(3/N)TQ2461	\$773	\$823	\$848
30"	EP(3/N)TQ3061	\$833	\$883	\$908
36"	EP(3/N)TQ3661	\$918	\$968	\$993
42"	EP(3/N)TQ4261	\$978	\$1,028	\$1,053
48"	EP(3/N)TQ4861	\$1,038	\$1,088	\$1,113
60"	EP(3/N)TQ6061	\$1,147	\$1,197	\$1,222

66" H

12"	EP(3/N)TQ1266	\$676	\$726	\$751
18"	EP(3/N)TQ1866	\$736	\$786	\$811
24"	EP(3/N)TQ2466	\$797	\$847	\$872
30"	EP(3/N)TQ3066	\$857	\$907	\$932
36"	EP(3/N)TQ3666	\$953	\$1,003	\$1,028
42"	EP(3/N)TQ4266	\$1,014	\$1,064	\$1,089
48"	EP(3/N)TQ4866	\$1,074	\$1,124	\$1,149
60"	EP(3/N)TQ6066	\$1,183	\$1,233	\$1,258

81" H

12"	EP(3/N)TQ1281	\$676	\$726	\$751
18"	EP(3/N)TQ1881	\$736	\$786	\$811
24"	EP(3/N)TQ2481	\$797	\$847	\$872
30"	EP(3/N)TQ3081	\$857	\$907	\$932
36"	EP(3/N)TQ3681	\$953	\$1,003	\$1,028
42"	EP(3/N)TQ4281	\$1,014	\$1,064	\$1,089
48"	EP(3/N)TQ4881	\$1,074	\$1,124	\$1,149
60"	EP(3/N)TQ6081	\$1,183	\$1,233	\$1,258



		Top Cap	Panel Type	W	H
EP	Equity Panel	3 Beveled N Flat	TQ Tequity	36	29
EP		N	TQ	36	29

Sliding Doors

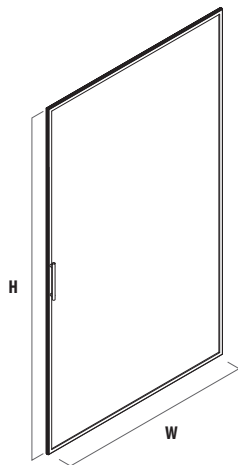

49" H			INSERT TYPE		LAMINATE INSERT			PAINT	
OPENING	ACTUAL OPENING	MODEL #	PG	CR	L1	L2	L3	P2	P3
36"	34.5"	EDR()3649(L/R)B	\$1,904	\$2,665	\$1,820	\$2,002	\$2,184	+ \$30	+ \$60

54" H			INSERT TYPE		LAMINATE INSERT			PAINT	
OPENING	ACTUAL OPENING	MODEL #	PG	CR	L1	L2	L3	P2	P3
36"	34.5"	EDR()3654(L/R)B	\$2,000	\$2,906	\$2,024	\$2,226	\$2,429	+ \$30	+ \$60

61" H			INSERT TYPE		LAMINATE INSERT			PAINT	
OPENING	ACTUAL OPENING	MODEL #	PG	CR	L1	L2	L3	P2	P3
36"	34.5"	EDR()3661(L/R)B	\$2,085	\$3,269	\$2,266	\$2,493	\$2,719	+ \$30	+ \$60

66" H			INSERT TYPE		LAMINATE INSERT			PAINT	
OPENING	ACTUAL OPENING	MODEL #	PG	CR	L1	L2	L3	P2	P3
36"	34.5"	EDR()3666(L/R)B	\$2,206	\$3,510	\$2,266	\$2,493	\$2,719	+ \$30	+ \$60

EDR	Equity Door	Insert Type	W	H	Door Open	Door Handle
		CR Corian	36	61	L Left	B Bar
		PG Plexiglass			R Right	
		LM Laminate				
EDR		LM	36	61	L	B

Specify

1. Model #
2. Insert type
3. Insert color
4. Paint

Application Notes

Sliding doors can mount on an end or corner post and require a straight, unobstructed panel run of at least 42" for their open position. Left/Right refers to opening direction.

NOTE: Sliding doors are only compatible with N (flat) top caps.

Insert Type

- CR . Corian
- PG . Plexiglass
- LM . Laminate

Plexiglass Finishes

- CL . Clear
- IC . Ice
- SM . Smoked
- TR . Translucent
- LF . Frost

Corian Finishes

- Glacier White CR001
- Pearl Grey CR002
- Corian Clay CR003
- Silver Grey CR004
- Corian Grey CR001

Assembly

- Included**
- Door
 - Hardware

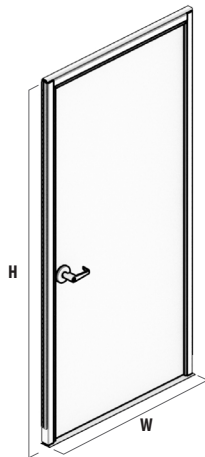

81" H

W	DOOR WIDTH	MODEL #	LAMINATE			PAINT	
			L1	L2	L3	P2	P3
36"	30"	EHDR(3/N)3681(L/R)	\$3,520	\$3,872	\$4,224	+\$30	+\$60
42"	36"	EHDR(3/N)4281(L/R)	\$3,640	\$4,004	\$4,368	+\$30	+\$60

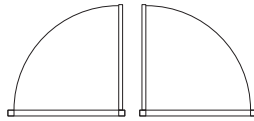

R – Right Door L – Left Door

Metal Shrouds — for Doors

DESCRIPTION	MODEL #	PAINT		
		P1	P2	P3
Door – Straight Pair	EP3DSP	\$66	\$72	\$80
Door – L Outside Right	EP3DLR	\$44	\$47	\$51
Door – L Outside Left	EP3DLL	\$44	\$47	\$51



Straight Pair

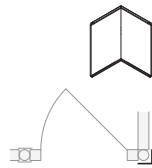

L outside Right

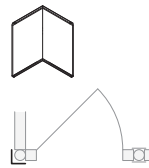

L outside Left

Specify

1. Model #
2. Laminate
3. Paint
4. Door Hardware Finish

Hardware Finishes (Hinged Doors)

- HDHAB** . . Aged Bronze
- HDHBC** . . Bright Chrome
- HDHMB** . . Matte Black
- HDHSC** . . Satin Chrome
- HDHSN** . . Satin Nickel
- HDHSS** . . Satin Stainless Steel

		Top Cap		W	H	Door
EDR	Equity Door	3	Beveled	36	81	L Left
		N	Flat			R Right
EHDR		N		36	81	L

Post Assemblies



Straight

H	MODEL #	PAINT		
		P1	P2	P3
29"	EP(3/N)P29S	\$179	\$187	\$195
41"	EP(3/N)P41S	\$181	\$189	\$197
49"	EP(3/N)P49S	\$183	\$191	\$199
54"	EP(3/N)P54S	\$186	\$194	\$202
61"	EP(3/N)P61S	\$188	\$196	\$204
66"	EP(3/N)P66S	\$190	\$198	\$206
81"	EP(3/N)P81S	\$211	\$219	\$227



2-way L

H	MODEL #	PAINT		
		P1	P2	P3
29"	EP(3/N)P29L	\$179	\$187	\$195
41"	EP(3/N)P41L	\$181	\$189	\$197
49"	EP(3/N)P49L	\$184	\$192	\$200
54"	EP(3/N)P54L	\$189	\$197	\$205
61"	EP(3/N)P61L	\$198	\$206	\$214
66"	EP(3/N)P66L	\$207	\$215	\$223
81"	EP(3/N)P81L	\$223	\$231	\$239

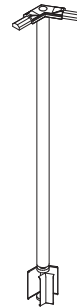

2-way 120

29"	EP3P29120	\$191	\$199	\$207
41"	EP3P41120	\$202	\$210	\$218
49"	EP3P49120	\$206	\$214	\$222
54"	EP3P54120	\$211	\$219	\$227
61"	EP3P61120	\$221	\$229	\$237
66"	EP3P66120	\$229	\$237	\$245
81"	EP3P81120	\$244	\$252	\$260

Specify

1. Model #
2. Paint

Application Notes

Used to connect panels of the same height.

Bottom glides on post allow for up to 1 1/2" of vertical adjustment.

Add "NS" to the end of the model number to specify without shroud for use with Tequity panels.

Assembly

Included

- Single height post
- Panel connector
- Appropriate metal shroud

Top Cap Styles

3 – Beveled

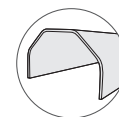

N – Flat



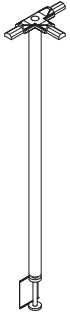

3-way T

H	MODEL #	PAINT		
		P1	P2	P3
29"	EP(3/N)P29T	\$179	\$187	\$195
41"	EP(3/N)P41T	\$181	\$189	\$197
49"	EP(3/N)P49T	\$183	\$191	\$199
54"	EP(3/N)P54T	\$186	\$194	\$202
61"	EP(3/N)P61T	\$189	\$197	\$205
66"	EP(3/N)P66T	\$197	\$205	\$213
81"	EP(3/N)P81T	\$212	\$220	\$228

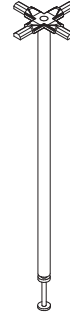

4-way X

H	MODEL #	PAINT		
		P1	P2	P3
29"	EP(3/N)P29X	\$179	\$187	\$195
41"	EP(3/N)P41X	\$181	\$189	\$197
49"	EP(3/N)P49X	\$183	\$191	\$199
54"	EP(3/N)P54X	\$186	\$194	\$202
61"	EP(3/N)P61X	\$188	\$196	\$204
66"	EP(3/N)P66X	\$190	\$198	\$206
81"	EP(3/N)P81X	\$206	\$214	\$222



3-way 120

29"	EP(3/N)P29Y	\$215	\$225	\$235
41"	EP(3/N)P41Y	\$218	\$228	\$238
49"	EP(3/N)P49Y	\$221	\$231	\$241
54"	EP(3/N)P54Y	\$223	\$233	\$243
61"	EP(3/N)P61Y	\$226	\$236	\$246
66"	EP(3/N)P66Y	\$232	\$242	\$252
81"	EP(3/N)P81Y	\$248	\$258	\$268



Carpet Gripper

DESCRIPTION	MODEL #	BLACK ONLY
12 Pack	EP1CG12	\$45

Top Cap						H		Connection Type		Options	
Equity Panel		Beveled		Post		29		120		NS No Shroud (Tequity Only)	
Equity Panel		Flat		Post		29		E End w/post			
Equity Panel		Flat		Post		29		L 2-way L			
Equity Panel		Flat		Post		29		T 3-way T			
Equity Panel		Flat		Post		29		S Straight			
Equity Panel		Flat		Post		29		X 4-way			
Equity Panel		Flat		Post		29		Y 3-way 120			
EP		3	Beveled	P	Post	29		120	2-way 120	NS	No Shroud (Tequity Only)
EP		N	Flat	P	Post	29		E	End w/post		
EP		N	Flat	P	Post	29		L	2-way L		
EP		N	Flat	P	Post	29		T	3-way T		
EP		N	Flat	P	Post	29		S	Straight		
EP		N	Flat	P	Post	29		X	4-way		
EP		N	Flat	P	Post	29		Y	3-way 120		

End Kits



End w/Post

H	MODEL #	PAINT		
		P1	P2	P3
29"	EP(3/N)P29E	\$191	\$199	\$207
41"	EP(3/N)P41E	\$197	\$205	\$213
49"	EP(3/N)P49E	\$203	\$211	\$219
54"	EP(3/N)P54E	\$206	\$214	\$222
61"	EP(3/N)P61E	\$217	\$225	\$233
66"	EP(3/N)P66E	\$224	\$232	\$240
81"	EP(3/N)P81E	\$239	\$247	\$255

End w/Post

Specify

1. Model #
2. Paint

Application Notes

Used to finish a panel end that is not being connected to another panel.

Add "NS" to the end of the model number to specify without shroud for use with Tequity panels.

Assembly

Included

- Single height post
- Panel connector
- Appropriate metal shroud

Top Cap Styles

3 – Beveled

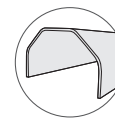

N – Flat

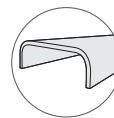



Panel Wall Starter

W	D	H	H (Actual)	MODEL #	PAINT		
					P1	P2	P3
1 1/2"	1/2"	29"	23"	EP(3/N)PWS29	\$53	\$54	\$57
1 1/2"	1/2"	41"	35"	EP(3/N)PWS41	\$53	\$54	\$57
1 1/2"	1/2"	49"	43"	EP(3/N)PWS49	\$58	\$60	\$65
1 1/2"	1/2"	54"	49"	EP(3/N)PWS54	\$60	\$65	\$70
1 1/2"	1/2"	61"	55"	EP(3/N)PWS61	\$60	\$65	\$70
1 1/2"	1/2"	66"	60"	EP(3/N)PWS66	\$62	\$67	\$74
1 1/2"	1/2"	81"	75"	EP(3/N)PWS81	\$70	\$75	\$82



Wall Mounted Channel

2 7/8"	3/4"	29"	23"	EP3WMC29	\$134	\$139	\$146
2 7/8"	3/4"	41"	35"	EP3WMC41	\$134	\$139	\$146
2 7/8"	3/4"	49"	43"	EP3WMC49	\$138	\$145	\$153
2 7/8"	3/4"	54"	49"	EP3WMC54	\$140	\$147	\$155
2 7/8"	3/4"	61"	55"	EP3WMC61	\$156	\$162	\$173
2 7/8"	3/4"	66"	60"	EP3WMC66	\$160	\$173	\$178
2 7/8"	3/4"	81"	75"	EP3WMC81	\$195	\$202	\$213
2 7/8"	3/4"	120"	120"	EP3WMC120	\$300	\$315	\$331

Panel Wall Starter

Specify

1. Model #
2. Paint

Application Notes

Used to start a run of panels by fastening to an existing wall and attaching a connector assembly to it. Creates 1/4" space from face of wall to centerline of post. Constructed of steel.

NOTE: Neutral Posture assumes no responsibility for wall construction or performance of fasteners used.

Assembly

Included

- Panel top & bottom hook
- Panel connector

Not Included

- Fasteners to attach to wall

Ordered Separately

- Post
- Shrouds

Top Cap Styles

3 – Beveled

N – Flat

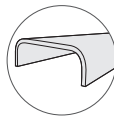
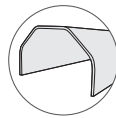

Wall Mounted Channel

Specify

1. Model #
2. Paint

Application Notes

Allows hanging of all components and accessories on reinforced building walls.

NOTE: Neutral Posture assumes no responsibility for wall construction or performance of fasteners used.

Assembly

Included

- Extruded aluminum channel

Posts

Multi-height

Single Height

H	MODEL #	PAINT		
		P1	P2	P3
29"	EP3P29	\$111	\$114	\$117
41"	EP3P41	\$113	\$116	\$119
49"	EP3P49	\$116	\$119	\$122
54"	EP3P54	\$119	\$122	\$125
61"	EP3P61	\$126	\$129	\$132
66"	EP3P66	\$129	\$132	\$135
81"	EP3P81	\$141	\$144	\$147

Dual Height

29"/41"	EP3DP2941	\$187	\$198	\$209
29"/49"	EP3DP2949	\$198	\$209	\$220
29"/54"	EP3DP2954	\$198	\$209	\$220
29"/61"	EP3DP2961	\$211	\$222	\$233
29"/66"	EP3DP2966	\$211	\$222	\$233
29"/81"	EP3DP2981	\$235	\$246	\$257
41"/49"	EP3DP4149	\$198	\$209	\$220
41"/54"	EP3DP4154	\$198	\$209	\$220
41"/61"	EP3DP4161	\$211	\$222	\$233
41"/66"	EP3DP4166	\$211	\$222	\$233
41"/81"	EP3DP4181	\$235	\$246	\$257
49"/54"	EP3DP4954	\$198	\$209	\$220
49"/61"	EP3DP4961	\$211	\$222	\$233
49"/66"	EP3DP4966	\$211	\$222	\$233
49"/81"	EP3DP4981	\$235	\$246	\$257
54"/61"	EP3DP5461	\$211	\$222	\$233
54"/66"	EP3DP5466	\$211	\$222	\$233
54"/81"	EP3DP5481	\$235	\$246	\$257
61"/66"	EP3DP6166	\$211	\$222	\$233
61"/81"	EP3DP6181	\$235	\$246	\$257
66"/81"	EP3DP6681	\$235	\$246	\$257

Triple Height

H	MODEL #	PAINT		
		P1	P2	P3
29"/41"/49"	EP3TP294149	\$235	\$246	\$257
29"/41"/54"	EP3TP294154	\$235	\$246	\$257
29"/41"/61"	EP3TP294161	\$242	\$253	\$264
29"/41"/66"	EP3TP294166	\$242	\$253	\$264
29"/41"/81"	EP3TP294181	\$277	\$288	\$299
29"/49"/54"	EP3TP294954	\$235	\$246	\$257
29"/49"/61"	EP3TP294961	\$242	\$253	\$264
29"/49"/66"	EP3TP294966	\$242	\$253	\$264
29"/49"/81"	EP3TP294981	\$277	\$288	\$299
29"/54"/61"	EP3TP295461	\$242	\$253	\$264
29"/54"/66"	EP3TP295466	\$242	\$253	\$264
29"/54"/81"	EP3TP295481	\$277	\$288	\$299
29"/61"/66"	EP3TP296166	\$242	\$253	\$264
29"/61"/81"	EP3TP296181	\$277	\$288	\$299
41"/49"/54"	EP3TP414954	\$235	\$246	\$257
41"/49"/61"	EP3TP414961	\$242	\$253	\$264
41"/49"/66"	EP3TP414966	\$242	\$253	\$264
41"/49"/81"	EP3TP414981	\$277	\$288	\$299
41"/54"/61"	EP3TP415461	\$242	\$253	\$264
41"/54"/66"	EP3TP415466	\$242	\$253	\$264
41"/54"/81"	EP3TP415481	\$277	\$288	\$299
41"/61"/66"	EP3TP416166	\$242	\$253	\$264
41"/61"/81"	EP3TP416181	\$277	\$288	\$299
49"/54"/61"	EP3TP495461	\$242	\$253	\$264
49"/54"/66"	EP3TP495466	\$242	\$253	\$264
49"/54"/81"	EP3TP495481	\$277	\$288	\$299
49"/61"/66"	EP3TP496166	\$242	\$253	\$264
49"/61"/81"	EP3TP496181	\$277	\$288	\$299
54"/61"/66"	EP3TP546166	\$242	\$253	\$264
54"/61"/81"	EP3TP546181	\$277	\$288	\$299

Specify

1. Model #
2. Paint

Application Notes

Bottom glides on post allow for up to 1 ½" of vertical adjustment.

Specify one multi-height panel connector (**EP3PCMF**) for each low panel when using either a dual or triple height post in a multi-height connection.

Dual Height Posts
Used where 2 monolithic panels of 2 different heights intersect.

Triple Height Posts
Used where 3 monolithic panels of 3 different heights intersect.

Assembly

Included

- Multi-height post

Ordered Separately

- Panel connectors
- Metal shrouds

Connectors

DESCRIPTION	MODEL #	PAINT		
		P1	P2	P3
Straight	EP(3/N)PCS	\$44	\$47	\$50
2-way L	EP(3/N)PCL	\$44	\$47	\$50
2-way 120	EP(3/N)PC120	\$44	\$47	\$50
2-way adjustable angle	EPNPCA	\$57	\$60	\$63
3-way T	EP(3/N)PCT	\$57	\$60	\$63
3-way Y 120	EP(3/N)PCY	\$57	\$60	\$63
4-way X	EP(3/N)PCX	\$57	\$60	\$63
End	EP(3/N)PCEP	\$44	\$47	\$50
Multi-height filler	EP(3/N)PCMF	\$44	\$47	\$50
Trim filler	EPNPCT	\$44	\$47	\$50



Straight



2-way L



2-way
Adjustable angle



3-way T



3-way Y 120



4-way X



End



Multi-height filler



Trim filler

Metal Shrouds

DESCRIPTION	MODEL #	PAINT		
		P1	P2	P3
Straight	EP3SS	\$33	\$36	\$40
L outside	EP3SL	\$44	\$47	\$51
120 outside	EP3SO120	\$44	\$47	\$51
120 inside	EP3SI120	\$44	\$47	\$51
End	EP3SEP	\$57	\$60	\$64



Straight



L outside



120 outside



120 inside



End

Specify

1. Model #
2. Paint

Top Cap Styles

3 – Beveled

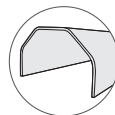

N – Flat

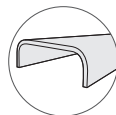

Stack-On Panels

COMPONENTS

Equity stack-on panels provide the flexibility to increase the overall height of any standard Equity panel.

The stack-on panel is available in all standard Equity widths and a variety of heights in both slotted and slotless versions.

STACK-ON PANELS W/ SLOTS

Stack-on panels with slots provide the capability to hang standard Equity components such as shelves and overheads as long as the weight load does not exceed 3lbs. per linear inch.

STACK-ON PANELS W/O SLOTS

Stack-on panels without slots do not allow for hanging components, but do provide a cleaner aesthetic when specifying window applications.

Up to two (2) load bearing stack-on panels may be stacked on top of a standard Equity panel as long as the total height above the base panels is no taller than 40" and neither individual stack-on panel is taller than 20".

Stack-on panel width must match the width of the panel it is stacking on.

Stack-on panel connectors must be used between adjacent stack-on panels.

STACK-ON PANEL CONNECTORS

STANDARD STACK-ON POST

Standard stack-on post bottom uses a conical shaped bolt that connects it to the full height post directly beneath it. Panel connectors for the top of the stack-on post must be ordered separately to match the geometry of the stack-on panels.

EXTENDED STACK-ON POST

Extended stack-on post bottom uses a double-threaded round connector to attach to the full-height post directly beneath it. Multi-height panel connectors (**EPNPCMF**) must be used on either side of this connector to provide a smooth transition for full-height post covers. Standard panel connectors are used along the top of the stack-on panels.

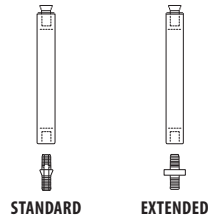

SPECIFYING STACK-ON CONFIGURATIONS

All connectors between the base panel and stack-on panel **MUST** have flat (N) profile.

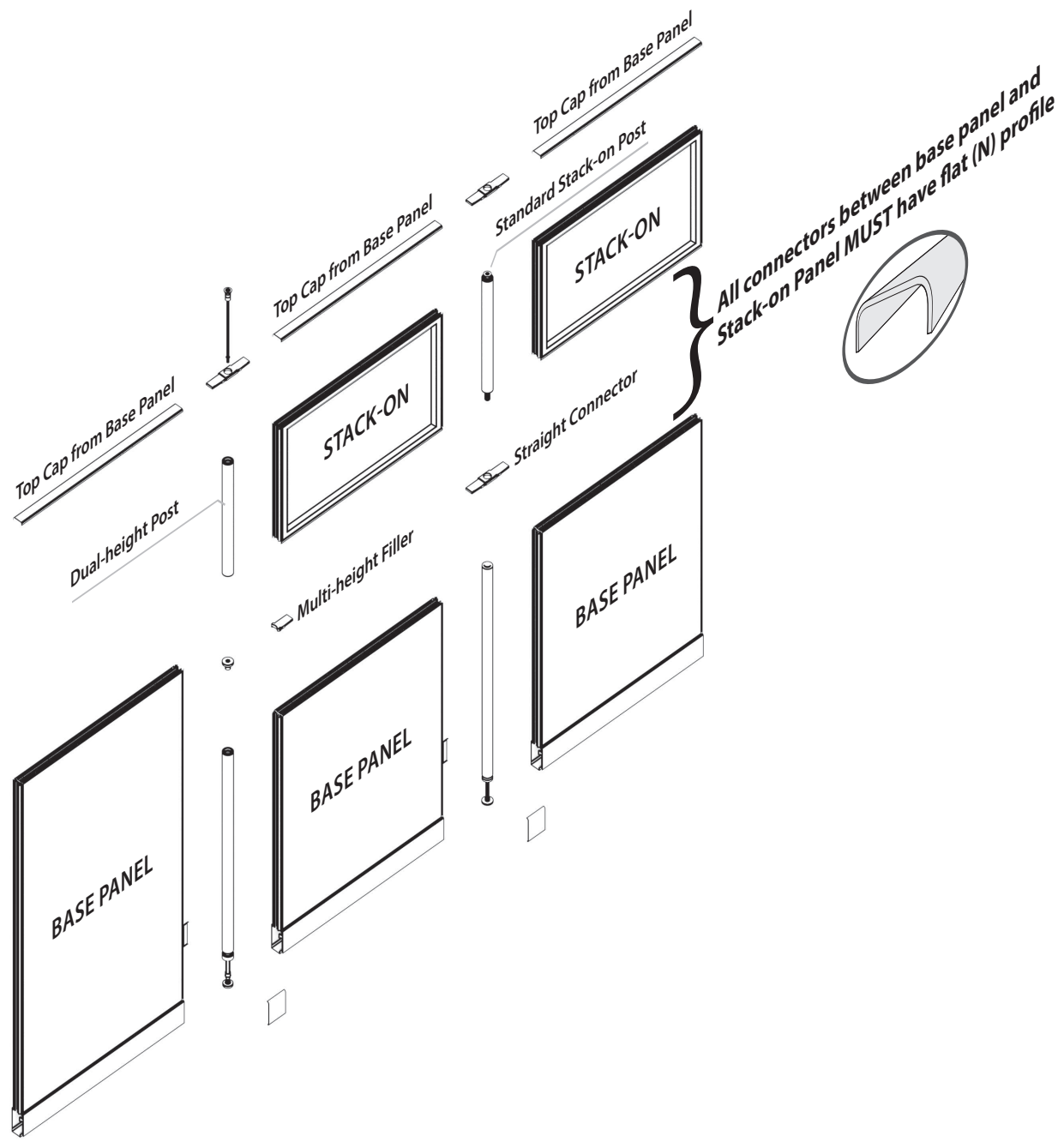

Stack-On Configurations

Using Standard Stack-on Posts

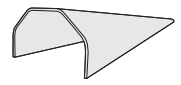
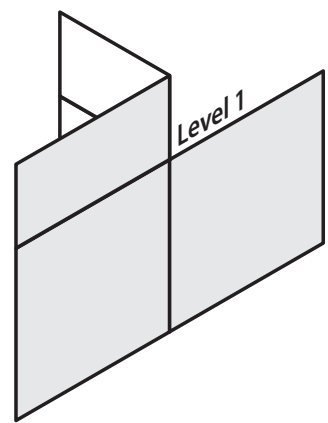
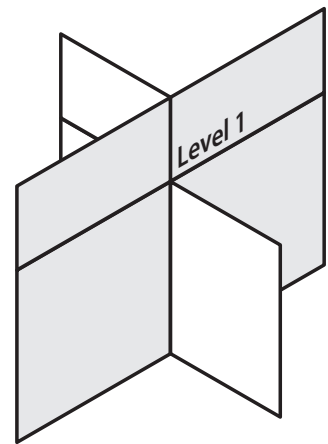
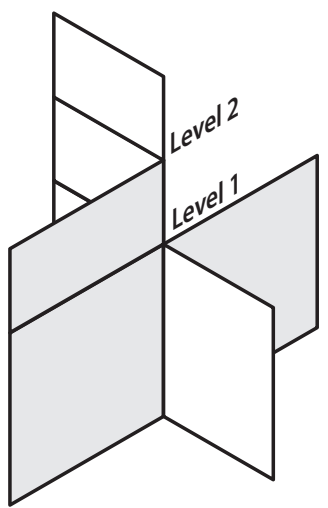

BEVELED TOP CAP

LEVEL 1

Trim Filler
EPNCTF

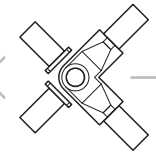

Beveled L
EP3PCL

LEVEL 2

Trim Filler
EPNCTF

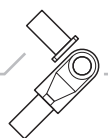

Beveled End w/post
EP3PCE

LEVEL 1

Trim Filler
EPNCTF



Flat Multi-height Filler
EPNCMF

Beveled End w/post
EP3PCE

Trim Filler
EPNCTF

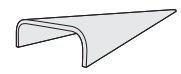

FLAT TOP CAP

Flat X
EPNPCX

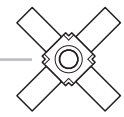

Flat X
EPNPCX

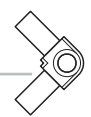

Flat X
EPNPCX

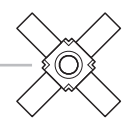

Flat T
EPNPCT

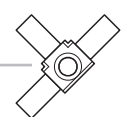

Stack-On Configurations

Using Standard Stack-on Posts

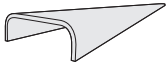
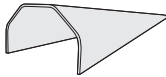

BEVELED TOP CAP

FLAT TOP CAP

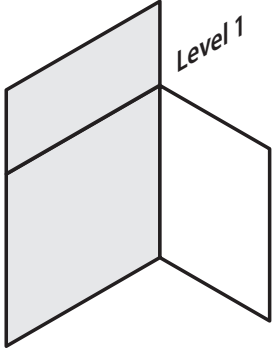

LEVEL 1

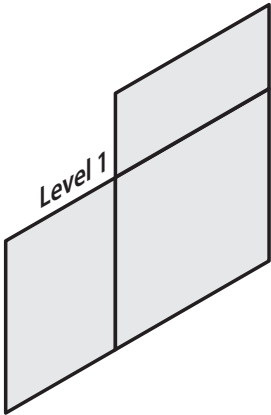
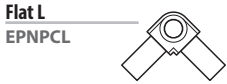
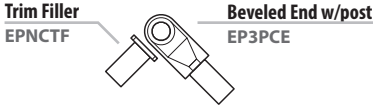

LEVEL 1

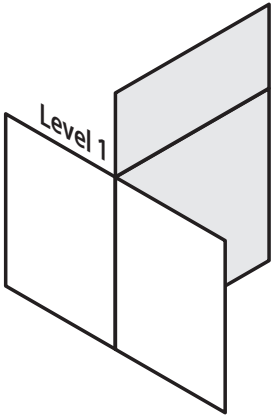
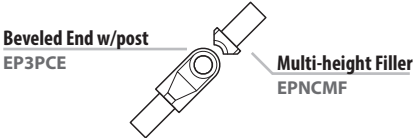

LEVEL 1

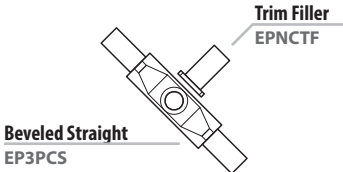

Stack-on Panels

Fabric with Slots

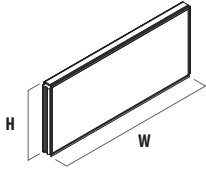

12" H

W	MODEL #	FABRIC								PAINT	
		A	B	C	D	E	F	G	H	P2	P3
12"	EP1SF1212	\$483	\$503	\$533	\$573	\$613	\$658	\$708	\$763	+ \$25	+ \$49
18"	EP1SF1812	\$507	\$527	\$557	\$597	\$637	\$682	\$732	\$787	+ \$25	+ \$49
24"	EP1SF2412	\$531	\$551	\$581	\$621	\$661	\$706	\$756	\$811	+ \$25	+ \$49
30"	EP1SF3012	\$555	\$575	\$605	\$645	\$685	\$730	\$780	\$835	+ \$25	+ \$49
36"	EP1SF3612	\$580	\$610	\$650	\$700	\$770	\$850	\$940	\$1,050	+ \$25	+ \$49
42"	EP1SF4212	\$604	\$634	\$674	\$724	\$794	\$874	\$964	\$1,074	+ \$25	+ \$49
48"	EP1SF4812	\$628	\$658	\$698	\$748	\$818	\$898	\$988	\$1,098	+ \$25	+ \$49
60"	EP1SF6012	\$652	\$682	\$722	\$772	\$842	\$922	\$1,012	\$1,122	+ \$25	+ \$49

13" H

12"	EP1SF1213	\$507	\$527	\$557	\$597	\$637	\$682	\$732	\$787	+ \$25	+ \$49
18"	EP1SF1813	\$531	\$551	\$581	\$621	\$661	\$706	\$756	\$811	+ \$25	+ \$49
24"	EP1SF2413	\$555	\$575	\$605	\$645	\$685	\$730	\$780	\$835	+ \$25	+ \$49
30"	EP1SF3013	\$580	\$620	\$670	\$730	\$800	\$890	\$990	\$1,110	+ \$25	+ \$49
36"	EP1SF3613	\$604	\$644	\$694	\$754	\$824	\$914	\$1,014	\$1,134	+ \$25	+ \$49
42"	EP1SF4213	\$628	\$668	\$718	\$778	\$848	\$938	\$1,038	\$1,158	+ \$25	+ \$49
48"	EP1SF4813	\$652	\$692	\$742	\$802	\$872	\$962	\$1,062	\$1,182	+ \$25	+ \$49
60"	EP1SF6013	\$676	\$716	\$766	\$826	\$896	\$986	\$1,086	\$1,206	+ \$25	+ \$49

15" H

12"	EP1SF1215	\$531	\$551	\$581	\$621	\$666	\$716	\$771	\$831	+ \$25	+ \$49
18"	EP1SF1815	\$555	\$575	\$605	\$645	\$690	\$740	\$795	\$855	+ \$25	+ \$49
24"	EP1SF2415	\$580	\$600	\$630	\$670	\$715	\$765	\$820	\$880	+ \$25	+ \$49
30"	EP1SF3015	\$604	\$644	\$694	\$754	\$824	\$924	\$1,034	\$1,154	+ \$25	+ \$49
36"	EP1SF3615	\$628	\$668	\$718	\$778	\$848	\$948	\$1,058	\$1,178	+ \$25	+ \$49
42"	EP1SF4215	\$652	\$692	\$742	\$802	\$872	\$972	\$1,082	\$1,202	+ \$25	+ \$49
48"	EP1SF4815	\$676	\$716	\$766	\$826	\$896	\$996	\$1,106	\$1,226	+ \$25	+ \$49
60"	EP1SF6015	\$700	\$740	\$790	\$850	\$920	\$1,020	\$1,130	\$1,250	+ \$25	+ \$49

Specify

1. Model #
2. Fabric
3. Paint

Assembly

- Included**
- Stack-on panel
 - Flat (N) top cap attached to the bottom of stack-on panel

Not Included

- Top cap
(use top cap from base panel)

Ordered Separately

- Stack-on posts
- Panel connectors

Top Cap Styles

3 – Beveled

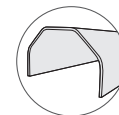

N – Flat

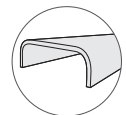

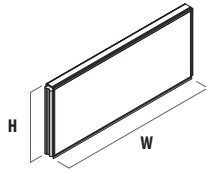

17" H

W	MODEL #	FABRIC								PAINT	
		A	B	C	D	E	F	G	H	P2	P3
12"	EP1SF1217	\$555	\$585	\$625	\$670	\$720	\$775	\$835	\$900	+ \$25	+ \$49
18"	EP1SF1817	\$580	\$610	\$650	\$695	\$745	\$800	\$860	\$925	+ \$25	+ \$49
24"	EP1SF2417	\$604	\$634	\$674	\$719	\$769	\$824	\$884	\$949	+ \$25	+ \$49
30"	EP1SF3017	\$628	\$678	\$738	\$808	\$898	\$1,008	\$1,128	\$1,258	+ \$25	+ \$49
36"	EP1SF3617	\$652	\$702	\$762	\$832	\$922	\$1,032	\$1,152	\$1,282	+ \$25	+ \$49
42"	EP1SF4217	\$676	\$726	\$786	\$856	\$946	\$1,056	\$1,176	\$1,306	+ \$25	+ \$49
48"	EP1SF4817	\$700	\$750	\$810	\$880	\$970	\$1,080	\$1,200	\$1,330	+ \$25	+ \$49
60"	EP1SF6017	\$725	\$775	\$835	\$905	\$995	\$1,105	\$1,225	\$1,355	+ \$25	+ \$49

20" H

12"	EP1SF1220	\$580	\$610	\$650	\$695	\$745	\$800	\$860	\$930	+ \$25	+ \$49
18"	EP1SF1820	\$604	\$634	\$674	\$719	\$769	\$824	\$884	\$954	+ \$25	+ \$49
24"	EP1SF2420	\$628	\$658	\$698	\$743	\$793	\$848	\$908	\$978	+ \$25	+ \$49
30"	EP1SF3020	\$652	\$702	\$762	\$832	\$932	\$1,062	\$1,202	\$1,352	+ \$25	+ \$49
36"	EP1SF3620	\$676	\$726	\$786	\$856	\$956	\$1,086	\$1,226	\$1,376	+ \$25	+ \$49
42"	EP1SF4220	\$700	\$750	\$810	\$880	\$980	\$1,110	\$1,250	\$1,400	+ \$25	+ \$49
48"	EP1SF4820	\$736	\$786	\$846	\$916	\$1,016	\$1,146	\$1,286	\$1,436	+ \$25	+ \$49
60"	EP1SF6020	\$760	\$810	\$870	\$940	\$1,040	\$1,170	\$1,310	\$1,460	+ \$25	+ \$49

		Insert Type		W	H
EP15	Stack-on Panel	F	Fabric	36	20
EP15		F		36	20

Stack-on Panels

Fabric without Slots

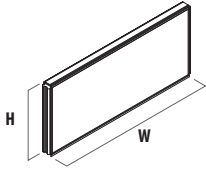

12" H

W	MODEL #	FABRIC								PAINT	
		A	B	C	D	E	F	G	H	P2	P3
12"	EP1SF1212N	\$483	\$503	\$533	\$573	\$613	\$658	\$708	\$763	+ \$25	+ \$49
18"	EP1SF1812N	\$507	\$527	\$557	\$597	\$637	\$682	\$732	\$787	+ \$25	+ \$49
24"	EP1SF2412N	\$531	\$551	\$581	\$621	\$661	\$706	\$756	\$811	+ \$25	+ \$49
30"	EP1SF3012N	\$555	\$575	\$605	\$645	\$685	\$730	\$780	\$835	+ \$25	+ \$49
36"	EP1SF3612N	\$580	\$610	\$650	\$700	\$770	\$850	\$940	\$1,050	+ \$25	+ \$49
42"	EP1SF4212N	\$604	\$634	\$674	\$724	\$794	\$874	\$964	\$1,074	+ \$25	+ \$49
48"	EP1SF4812N	\$628	\$658	\$698	\$748	\$818	\$898	\$988	\$1,098	+ \$25	+ \$49
60"	EP1SF6012N	\$652	\$682	\$722	\$772	\$842	\$922	\$1,012	\$1,122	+ \$25	+ \$49

13" H

12"	EP1SF1213N	\$507	\$527	\$557	\$597	\$637	\$682	\$732	\$787	+ \$25	+ \$49
18"	EP1SF1813N	\$531	\$551	\$581	\$621	\$661	\$706	\$756	\$811	+ \$25	+ \$49
24"	EP1SF2413N	\$555	\$575	\$605	\$645	\$685	\$730	\$780	\$835	+ \$25	+ \$49
30"	EP1SF3013N	\$580	\$620	\$670	\$730	\$800	\$890	\$990	\$1,110	+ \$25	+ \$49
36"	EP1SF3613N	\$604	\$644	\$694	\$754	\$824	\$914	\$1,014	\$1,134	+ \$25	+ \$49
42"	EP1SF4213N	\$628	\$668	\$718	\$778	\$848	\$938	\$1,038	\$1,158	+ \$25	+ \$49
48"	EP1SF4813N	\$652	\$692	\$742	\$802	\$872	\$962	\$1,062	\$1,182	+ \$25	+ \$49
60"	EP1SF6013N	\$676	\$716	\$766	\$826	\$896	\$986	\$1,086	\$1,206	+ \$25	+ \$49

15" H

12"	EP1SF1215N	\$531	\$551	\$581	\$621	\$666	\$716	\$771	\$831	+ \$25	+ \$49
18"	EP1SF1815N	\$555	\$575	\$605	\$645	\$690	\$740	\$795	\$855	+ \$25	+ \$49
24"	EP1SF2415N	\$580	\$600	\$630	\$670	\$715	\$765	\$820	\$880	+ \$25	+ \$49
30"	EP1SF3015N	\$604	\$644	\$694	\$754	\$824	\$924	\$1,034	\$1,154	+ \$25	+ \$49
36"	EP1SF3615N	\$628	\$668	\$718	\$778	\$848	\$948	\$1,058	\$1,178	+ \$25	+ \$49
42"	EP1SF4215N	\$652	\$692	\$742	\$802	\$872	\$972	\$1,082	\$1,202	+ \$25	+ \$49
48"	EP1SF4815N	\$676	\$716	\$766	\$826	\$896	\$996	\$1,106	\$1,226	+ \$25	+ \$49
60"	EP1SF6015N	\$700	\$740	\$790	\$850	\$920	\$1,020	\$1,130	\$1,250	+ \$25	+ \$49

17" H

12"	EP1SF1217N	\$555	\$585	\$625	\$670	\$720	\$775	\$835	\$900	+ \$25	+ \$49
18"	EP1SF1817N	\$580	\$610	\$650	\$695	\$745	\$800	\$860	\$925	+ \$25	+ \$49
24"	EP1SF2417N	\$604	\$634	\$674	\$719	\$769	\$824	\$884	\$949	+ \$25	+ \$49
30"	EP1SF3017N	\$628	\$678	\$738	\$808	\$898	\$1,008	\$1,128	\$1,258	+ \$25	+ \$49
36"	EP1SF3617N	\$652	\$702	\$762	\$832	\$922	\$1,032	\$1,152	\$1,282	+ \$25	+ \$49
42"	EP1SF4217N	\$676	\$726	\$786	\$856	\$946	\$1,056	\$1,176	\$1,306	+ \$25	+ \$49
48"	EP1SF4817N	\$700	\$750	\$810	\$880	\$970	\$1,080	\$1,200	\$1,330	+ \$25	+ \$49
60"	EP1SF6017N	\$725	\$775	\$835	\$905	\$995	\$1,105	\$1,225	\$1,355	+ \$25	+ \$49

Specify

1. Model #
2. Fabric
3. Paint

Assembly

Included

- Stack-on panel
- Flat (N) top cap attached to the bottom of stack-on panel

Not Included

- Top cap
(use top cap from base panel)

Ordered Separately

- Stack-on posts
- Panel connectors

Top Cap Styles

3 – Beveled

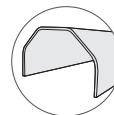

N – Flat

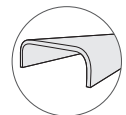

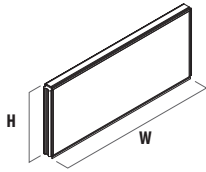

20" H

W	MODEL #	FABRIC								PAINT	
		A	B	C	D	E	F	G	H	P2	P3
12"	EP1SF1220N	\$580	\$610	\$650	\$695	\$745	\$800	\$860	\$930	+ \$25	+ \$49
18"	EP1SF1820N	\$604	\$634	\$674	\$719	\$769	\$824	\$884	\$954	+ \$25	+ \$49
24"	EP1SF2420N	\$628	\$658	\$698	\$743	\$793	\$848	\$908	\$978	+ \$25	+ \$49
30"	EP1SF3020N	\$652	\$702	\$762	\$832	\$932	\$1,062	\$1,202	\$1,352	+ \$25	+ \$49
36"	EP1SF3620N	\$676	\$726	\$786	\$856	\$956	\$1,086	\$1,226	\$1,376	+ \$25	+ \$49
42"	EP1SF4220N	\$700	\$750	\$810	\$880	\$980	\$1,110	\$1,250	\$1,400	+ \$25	+ \$49
48"	EP1SF4820N	\$736	\$786	\$846	\$916	\$1,016	\$1,146	\$1,286	\$1,436	+ \$25	+ \$49
60"	EP1SF6020N	\$760	\$810	\$870	\$940	\$1,040	\$1,170	\$1,310	\$1,460	+ \$25	+ \$49

25" H

12"	EP1SF1225N	\$604	\$634	\$674	\$719	\$779	\$849	\$929	\$1,019	+ \$25	+ \$49
18"	EP1SF1825N	\$628	\$658	\$698	\$743	\$803	\$873	\$953	\$1,043	+ \$25	+ \$49
24"	EP1SF2425N	\$652	\$682	\$722	\$767	\$827	\$897	\$977	\$1,067	+ \$25	+ \$49
30"	EP1SF3025N	\$676	\$726	\$786	\$866	\$996	\$1,146	\$1,306	\$1,476	+ \$25	+ \$49
36"	EP1SF3625N	\$700	\$750	\$810	\$890	\$1,020	\$1,170	\$1,330	\$1,500	+ \$25	+ \$49
42"	EP1SF4225N	\$725	\$775	\$835	\$915	\$1,045	\$1,195	\$1,355	\$1,525	+ \$25	+ \$49
48"	EP1SF4825N	\$760	\$810	\$870	\$950	\$1,080	\$1,230	\$1,390	\$1,560	+ \$25	+ \$49
60"	EP1SF6025N	\$809	\$859	\$919	\$999	\$1,129	\$1,279	\$1,439	\$1,609	+ \$25	+ \$49

32" H

12"	EP1SF1232N	\$628	\$658	\$698	\$743	\$803	\$893	\$993	\$1,103	+ \$25	+ \$49
18"	EP1SF1832N	\$652	\$682	\$722	\$767	\$827	\$917	\$1,017	\$1,127	+ \$25	+ \$49
24"	EP1SF2432N	\$676	\$706	\$746	\$791	\$851	\$941	\$1,041	\$1,151	+ \$25	+ \$49
30"	EP1SF3032N	\$700	\$750	\$810	\$900	\$1,050	\$1,220	\$1,410	\$1,630	+ \$25	+ \$49
36"	EP1SF3632N	\$725	\$775	\$835	\$925	\$1,075	\$1,245	\$1,435	\$1,655	+ \$25	+ \$49
42"	EP1SF4232N	\$749	\$799	\$859	\$949	\$1,099	\$1,269	\$1,459	\$1,679	+ \$25	+ \$49
48"	EP1SF4832N	\$784	\$834	\$894	\$984	\$1,134	\$1,304	\$1,494	\$1,714	+ \$25	+ \$49
60"	EP1SF6032N	\$821	\$871	\$931	\$1,021	\$1,171	\$1,341	\$1,531	\$1,751	+ \$25	+ \$49

37" H

12"	EP1SF1237N	\$652	\$692	\$742	\$802	\$882	\$972	\$1,072	\$1,182	+ \$25	+ \$49
18"	EP1SF1837N	\$676	\$716	\$766	\$826	\$906	\$996	\$1,096	\$1,206	+ \$25	+ \$49
24"	EP1SF2437N	\$700	\$740	\$790	\$850	\$930	\$1,020	\$1,120	\$1,230	+ \$25	+ \$49
30"	EP1SF3037N	\$725	\$795	\$875	\$965	\$1,125	\$1,295	\$1,495	\$1,745	+ \$25	+ \$49
36"	EP1SF3637N	\$749	\$819	\$899	\$989	\$1,149	\$1,319	\$1,519	\$1,769	+ \$25	+ \$49
42"	EP1SF4237N	\$773	\$843	\$923	\$1,013	\$1,173	\$1,343	\$1,543	\$1,793	+ \$25	+ \$49
48"	EP1SF4837N	\$809	\$879	\$959	\$1,049	\$1,209	\$1,379	\$1,579	\$1,829	+ \$25	+ \$49
60"	EP1SF6037N	\$845	\$915	\$995	\$1,085	\$1,245	\$1,415	\$1,615	\$1,865	+ \$25	+ \$49

		Insert Type		W	H	Slots	
EP15	Stack-on panel	F	Fabric	36	37	N	Without slots
EP15		F		36	37	N	

Stack-on Panels

Insert with Slots

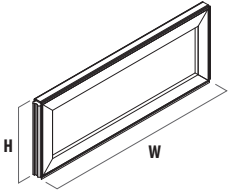

12" H

W	MODEL #	GLASS INSERT			LAMINATE INSERT			PAINT	
		PG	GL	DG	L1	L2	L3	P2	P3
12"	EP2S()1212	\$781	\$854	\$1,119	\$817	\$899	\$980	+\$25	+\$49
18"	EP2S()1812	\$805	\$889	\$1,155	\$841	\$925	\$1,009	+\$25	+\$49
24"	EP2S()2412	\$841	\$944	\$1,210	\$883	\$971	\$1,060	+\$25	+\$49
30"	EP2S()3012	\$865	\$980	\$1,269	\$907	\$998	\$1,088	+\$25	+\$49
36"	EP2S()3612	\$889	\$1,023	\$1,337	\$938	\$1,032	\$1,126	+\$25	+\$49
42"	EP2S()4212	\$914	\$1,058	\$1,397	\$962	\$1,058	\$1,154	+\$25	+\$49
48"	EP2S()4812	\$938	\$1,107	\$1,445	\$999	\$1,099	\$1,199	+\$25	+\$49
60"	EP2S()6012	\$962	\$1,179	\$1,602	\$1,058	\$1,164	\$1,270	+\$25	+\$49

13" H

12"	EP2S()1213	\$830	\$902	\$1,168	\$865	\$952	\$1,038	+\$25	+\$49
18"	EP2S()1813	\$854	\$938	\$1,203	\$889	\$978	\$1,067	+\$25	+\$49
24"	EP2S()2413	\$878	\$980	\$1,269	\$920	\$1,012	\$1,104	+\$25	+\$49
30"	EP2S()3013	\$902	\$1,016	\$1,330	\$944	\$1,038	\$1,133	+\$25	+\$49
36"	EP2S()3613	\$926	\$1,058	\$1,397	\$974	\$1,071	\$1,169	+\$25	+\$49
42"	EP2S()4213	\$950	\$1,095	\$1,457	\$999	\$1,099	\$1,199	+\$25	+\$49
48"	EP2S()4813	\$974	\$1,143	\$1,554	\$1,034	\$1,137	\$1,241	+\$25	+\$49
60"	EP2S()6013	\$986	\$1,203	\$1,686	\$1,083	\$1,191	\$1,300	+\$25	+\$49

15"

12"	EP2S()1215	\$854	\$926	\$1,192	\$889	\$978	\$1,067	+\$25	+\$49
18"	EP2S()1815	\$878	\$962	\$1,227	\$914	\$1,005	\$1,097	+\$25	+\$49
24"	EP2S()2415	\$902	\$1,004	\$1,294	\$944	\$1,038	\$1,133	+\$25	+\$49
30"	EP2S()3015	\$926	\$1,041	\$1,355	\$968	\$1,065	\$1,162	+\$25	+\$49
36"	EP2S()3615	\$950	\$1,083	\$1,421	\$999	\$1,099	\$1,199	+\$25	+\$49
42"	EP2S()4215	\$974	\$1,119	\$1,482	\$1,023	\$1,125	\$1,228	+\$25	+\$49
48"	EP2S()4815	\$986	\$1,155	\$1,566	\$1,047	\$1,152	\$1,256	+\$25	+\$49
60"	EP2S()6015	\$1,010	\$1,227	\$1,710	\$1,107	\$1,218	\$1,328	+\$25	+\$49

Specify

1. Model #
2. Insert type
3. Insert color
4. Paint

Plexiglass Finishes

- CL** . . Clear
IC . . Ice
SM . . Smoked
TR . . Translucent

Glass Finishes

- CL** . . Clear
GR . . Grey
SM . . Smoked
TR . . Translucent

Assembly

- Included**
- Stack-on panel
 - Flat (N) top cap attached to the bottom of stack-on panel

Not Included

- Top cap
(use top cap from base panel)

Ordered Separately

- Stack-on posts
- Panel connectors

Stack-on Panels

Insert with Slots

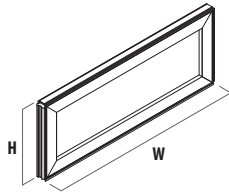

17" H

W	MODEL #	GLASS INSERT			LAMINATE INSERT			PAINT	
		PG	GL	DG	L1	L2	L3	P2	P3
12"	EP2S() 1217	\$878	\$950	\$1,216	\$902	\$992	\$1,082	+ \$25	+ \$49
18"	EP2S() 1817	\$902	\$986	\$1,276	\$938	\$1,032	\$1,126	+ \$25	+ \$49
24"	EP2S() 2417	\$926	\$1,028	\$1,342	\$968	\$1,065	\$1,162	+ \$25	+ \$49
30"	EP2S() 3017	\$950	\$1,065	\$1,403	\$992	\$1,091	\$1,189	+ \$25	+ \$49
36"	EP2S() 3617	\$974	\$1,107	\$1,469	\$1,023	\$1,125	\$1,228	+ \$25	+ \$49
42"	EP2S() 4217	\$986	\$1,131	\$1,541	\$1,034	\$1,137	\$1,241	+ \$25	+ \$49
48"	EP2S() 4817	\$1,010	\$1,179	\$1,638	\$1,071	\$1,178	\$1,285	+ \$25	+ \$49
60"	EP2S() 6017	\$1,034	\$1,252	\$1,783	\$1,131	\$1,244	\$1,357	+ \$25	+ \$49

20" H

12"	EP2S() 1220	\$902	\$974	\$1,288	\$938	\$1,032	\$1,126	+ \$25	+ \$49
18"	EP2S() 1820	\$926	\$1,010	\$1,324	\$962	\$1,058	\$1,154	+ \$25	+ \$49
24"	EP2S() 2420	\$950	\$1,052	\$1,390	\$992	\$1,091	\$1,190	+ \$25	+ \$49
30"	EP2S() 3020	\$974	\$1,089	\$1,427	\$1,016	\$1,118	\$1,219	+ \$25	+ \$49
36"	EP2S() 3620	\$986	\$1,119	\$1,530	\$1,034	\$1,137	\$1,241	+ \$25	+ \$49
42"	EP2S() 4220	\$1,010	\$1,155	\$1,614	\$1,058	\$1,164	\$1,270	+ \$25	+ \$49
48"	EP2S() 4820	\$1,034	\$1,203	\$1,710	\$1,095	\$1,205	\$1,314	+ \$25	+ \$49
60"	EP2S() 6020	\$1,058	\$1,276	\$1,855	\$1,155	\$1,271	\$1,386	+ \$25	+ \$49

		Insert Type		W	H
EP2S	Stack-on panel	DG	Designer glass insert	36	15
		GL	Glass insert		
		PG	Plexiglass insert		
		LM	Laminate insert		
EP2S		PG		36	15

Pricing is for P1 paint colors. Add the appropriate upcharge if using P2 or P3 trim.

Stack-on Panels

Insert without Slots

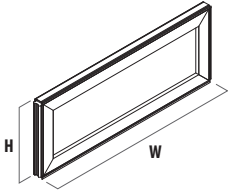

12" H		GLASS INSERT			LAMINATE INSERT			PAINT	
W	MODEL #	PG	GL	DG	L1	L2	L3	P2	P3
12"	EP2S()1212N	\$781	\$854	\$1,119	\$817	\$899	\$980	+\$25	+\$49
18"	EP2S()1812N	\$805	\$889	\$1,155	\$841	\$925	\$1,009	+\$25	+\$49
24"	EP2S()2412N	\$841	\$944	\$1,210	\$883	\$971	\$1,060	+\$25	+\$49
30"	EP2S()3012N	\$865	\$980	\$1,269	\$907	\$998	\$1,088	+\$25	+\$49
36"	EP2S()3612N	\$889	\$1,023	\$1,337	\$938	\$1,032	\$1,126	+\$25	+\$49
42"	EP2S()4212N	\$914	\$1,058	\$1,397	\$962	\$1,058	\$1,154	+\$25	+\$49
48"	EP2S()4812N	\$938	\$1,107	\$1,445	\$999	\$1,099	\$1,199	+\$25	+\$49
60"	EP2S()6012N	\$962	\$1,179	\$1,602	\$1,058	\$1,164	\$1,270	+\$25	+\$49

13" H		GLASS INSERT			LAMINATE INSERT			PAINT	
W	MODEL #	PG	GL	DG	L1	L2	L3	P2	P3
12"	EP2S()1213N	\$830	\$902	\$1,168	\$865	\$952	\$1,038	+\$25	+\$49
18"	EP2S()1813N	\$854	\$938	\$1,203	\$889	\$978	\$1,067	+\$25	+\$49
24"	EP2S()2413N	\$878	\$980	\$1,269	\$920	\$1,012	\$1,104	+\$25	+\$49
30"	EP2S()3013N	\$902	\$1,016	\$1,330	\$944	\$1,038	\$1,133	+\$25	+\$49
36"	EP2S()3613N	\$926	\$1,058	\$1,397	\$974	\$1,071	\$1,169	+\$25	+\$49
42"	EP2S()4213N	\$950	\$1,095	\$1,457	\$999	\$1,099	\$1,199	+\$25	+\$49
48"	EP2S()4813N	\$974	\$1,143	\$1,554	\$1,034	\$1,137	\$1,241	+\$25	+\$49
60"	EP2S()6013N	\$986	\$1,203	\$1,686	\$1,083	\$1,191	\$1,300	+\$25	+\$49

15" H		GLASS INSERT			LAMINATE INSERT			PAINT	
W	MODEL #	PG	GL	DG	L1	L2	L3	P2	P3
12"	EP2S()1215N	\$854	\$926	\$1,192	\$889	\$978	\$1,067	+\$25	+\$49
18"	EP2S()1815N	\$878	\$962	\$1,227	\$914	\$1,005	\$1,097	+\$25	+\$49
24"	EP2S()2415N	\$902	\$1,004	\$1,294	\$944	\$1,038	\$1,133	+\$25	+\$49
30"	EP2S()3015N	\$926	\$1,041	\$1,355	\$968	\$1,065	\$1,162	+\$25	+\$49
36"	EP2S()3615N	\$950	\$1,083	\$1,421	\$999	\$1,099	\$1,199	+\$25	+\$49
42"	EP2S()4215N	\$974	\$1,119	\$1,482	\$1,023	\$1,125	\$1,228	+\$25	+\$49
48"	EP2S()4815N	\$986	\$1,155	\$1,566	\$1,047	\$1,152	\$1,256	+\$25	+\$49
60"	EP2S()6015N	\$1,010	\$1,227	\$1,710	\$1,107	\$1,218	\$1,328	+\$25	+\$49

17" H		GLASS INSERT			LAMINATE INSERT			PAINT	
W	MODEL #	PG	GL	DG	L1	L2	L3	P2	P3
12"	EP2S()1217N	\$878	\$950	\$1,216	\$902	\$992	\$1,082	+\$25	+\$49
18"	EP2S()1817N	\$902	\$986	\$1,276	\$938	\$1,032	\$1,126	+\$25	+\$49
24"	EP2S()2417N	\$926	\$1,028	\$1,342	\$968	\$1,065	\$1,162	+\$25	+\$49
30"	EP2S()3017N	\$950	\$1,065	\$1,403	\$992	\$1,091	\$1,190	+\$25	+\$49
36"	EP2S()3617N	\$974	\$1,107	\$1,469	\$1,023	\$1,125	\$1,228	+\$25	+\$49
42"	EP2S()4217N	\$986	\$1,131	\$1,541	\$1,034	\$1,137	\$1,241	+\$25	+\$49
48"	EP2S()4817N	\$1,010	\$1,179	\$1,638	\$1,071	\$1,178	\$1,285	+\$25	+\$49
60"	EP2S()6017N	\$1,034	\$1,252	\$1,783	\$1,131	\$1,244	\$1,357	+\$25	+\$49

Specify

1. Model #
2. Insert Type
3. Insert color
4. Paint

Plexiglass Finishes

- CL . . Clear
 IC . . Ice
 SM . . Smoked
 TR . . Translucent

Glass Finishes

- CL . . Clear
 GR . . Grey
 SM . . Smoked
 TR . . Translucent

Assembly

Included

- Stack-on panel
- Flat (N) top cap attached to the bottom of stack-on panel

Not Included

- Top cap
(use top cap from base panel)

Ordered Separately

- Stack-on posts
- Panel connectors

Stack-on Panels

Insert without Slots

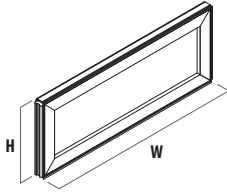

20" H

W	MODEL #	GLASS INSERT			LAMINATE INSERT			PAINT	
		PG	GL	DG	L1	L2	L3	P2	P3
12"	EP2S()1220N	\$902	\$974	\$1,288	\$938	\$1,032	\$1,126	+ \$25	+ \$49
18"	EP2S()1820N	\$926	\$1,010	\$1,324	\$962	\$1,058	\$1,154	+ \$25	+ \$49
24"	EP2S()2420N	\$950	\$1,052	\$1,390	\$992	\$1,091	\$1,190	+ \$25	+ \$49
30"	EP2S()3020N	\$974	\$1,089	\$1,427	\$1,016	\$1,118	\$1,219	+ \$25	+ \$49
36"	EP2S()3620N	\$986	\$1,119	\$1,530	\$1,034	\$1,137	\$1,241	+ \$25	+ \$49
42"	EP2S()4220N	\$1,010	\$1,155	\$1,614	\$1,058	\$1,164	\$1,270	+ \$25	+ \$49
48"	EP2S()4820N	\$1,034	\$1,203	\$1,710	\$1,095	\$1,205	\$1,314	+ \$25	+ \$49
60"	EP2S()6020N	\$1,058	\$1,276	\$1,855	\$1,155	\$1,271	\$1,386	+ \$25	+ \$49

25" H

12"	EP2S()1225N	\$938	\$1,010	\$1,324	\$974	\$1,071	\$1,169	+ \$25	+ \$49
18"	EP2S()1825N	\$962	\$1,047	\$1,361	\$999	\$1,099	\$1,199	+ \$25	+ \$49
24"	EP2S()2425N	\$986	\$1,089	\$1,427	\$1,028	\$1,131	\$1,234	+ \$25	+ \$49
30"	EP2S()3025N	\$1,010	\$1,125	\$1,487	\$1,052	\$1,157	\$1,262	+ \$25	+ \$49
36"	EP2S()3625N	\$1,034	\$1,168	\$1,578	\$1,083	\$1,191	\$1,300	+ \$25	+ \$49
42"	EP2S()4225N	\$1,058	\$1,203	\$1,662	\$1,107	\$1,218	\$1,328	+ \$25	+ \$49
48"	EP2S()4825N	\$1,095	\$1,252	\$1,759	\$1,143	\$1,257	\$1,372	+ \$25	+ \$49
60"	EP2S()6025N	\$1,131	\$1,324	\$1,952	\$1,203	\$1,323	\$1,444	+ \$25	+ \$49

32" H

12"	EP2S()1232N	\$962	\$1,034	\$1,348	\$999	\$1,099	\$1,199	+ \$25	+ \$49
18"	EP2S()1832N	\$986	\$1,071	\$1,409	\$1,023	\$1,125	\$1,228	+ \$25	+ \$49
24"	EP2S()2432N	\$1,010	\$1,113	\$1,475	\$1,052	\$1,157	\$1,262	+ \$25	+ \$49
30"	EP2S()3032N	\$1,034	\$1,149	\$1,583	\$1,076	\$1,184	\$1,291	+ \$25	+ \$49
36"	EP2S()3632N	\$1,058	\$1,192	\$1,699	\$1,107	\$1,218	\$1,328	+ \$25	+ \$49
42"	EP2S()4232N	\$1,083	\$1,227	\$1,807	\$1,131	\$1,244	\$1,357	+ \$25	+ \$49
48"	EP2S()4832N	\$1,119	\$1,288	\$1,916	\$1,179	\$1,297	\$1,415	+ \$25	+ \$49
60"	EP2S()6032N	\$1,179	\$1,397	\$2,121	\$1,276	\$1,404	\$1,531	+ \$25	+ \$49

37" H

12"	EP2S()1237N	\$986	\$1,058	\$1,397	\$1,023	\$1,125	\$1,228	+ \$25	+ \$49
18"	EP2S()1837N	\$1,010	\$1,107	\$1,469	\$1,058	\$1,164	\$1,270	+ \$25	+ \$49
24"	EP2S()2437N	\$1,034	\$1,155	\$1,590	\$1,095	\$1,205	\$1,314	+ \$25	+ \$49
30"	EP2S()3037N	\$1,058	\$1,203	\$1,710	\$1,131	\$1,244	\$1,357	+ \$25	+ \$49
36"	EP2S()3637N	\$1,083	\$1,252	\$1,831	\$1,168	\$1,285	\$1,402	+ \$25	+ \$49
42"	EP2S()4237N	\$1,107	\$1,300	\$1,928	\$1,203	\$1,323	\$1,444	+ \$25	+ \$49
48"	EP2S()4837N	\$1,143	\$1,361	\$2,037	\$1,252	\$1,377	\$1,502	+ \$25	+ \$49
60"	EP2S()6037N	\$1,203	\$1,445	\$2,290	\$1,324	\$1,456	\$1,589	+ \$25	+ \$49

		Insert Type		W	H	Slots	
EP2S	Stack-on panel	DG	Designer glass insert	36	15	N	Without Slots
		GL	Glass insert				
		PG	Plexiglass insert				
		LM	Laminate insert				
EP2S		PG		36	15	N	

Pricing is for P1 paint colors. Add the appropriate upcharge if using P2 or P3 trim.

Stack-on Panels

Perforated Aluminum Insert with Slots

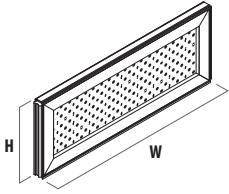

12" H

W	MODEL #	PA	INSERT PAINT			PAINT	
			P1	P2	P3	P2	P3
12"	EP2SPA1212	\$781	\$831	\$851	\$871	+\$25	+\$49
18"	EP2SPA1812	\$805	\$855	\$875	\$895	+\$25	+\$49
24"	EP2SPA2412	\$841	\$891	\$911	\$931	+\$25	+\$49
30"	EP2SPA3012	\$865	\$925	\$945	\$965	+\$25	+\$49
36"	EP2SPA3612	\$889	\$949	\$969	\$989	+\$25	+\$49
42"	EP2SPA4212	\$914	\$974	\$994	\$1,014	+\$25	+\$49
48"	EP2SPA4812	\$938	\$998	\$1,018	\$1,038	+\$25	+\$49
60"	EP2SPA6012	\$962	\$1,042	\$1,072	\$1,102	+\$25	+\$49

13" H

12"	EP2SPA1213	\$830	\$880	\$900	\$920	+\$25	+\$49
18"	EP2SPA1813	\$854	\$904	\$924	\$944	+\$25	+\$49
24"	EP2SPA2413	\$878	\$938	\$958	\$978	+\$25	+\$49
30"	EP2SPA3013	\$902	\$962	\$982	\$1,002	+\$25	+\$49
36"	EP2SPA3613	\$926	\$986	\$1,006	\$1,026	+\$25	+\$49
42"	EP2SPA4213	\$950	\$1,010	\$1,030	\$1,050	+\$25	+\$49
48"	EP2SPA4813	\$974	\$1,034	\$1,054	\$1,084	+\$25	+\$49
60"	EP2SPA6013	\$986	\$1,076	\$1,106	\$1,146	+\$25	+\$49

15"

12"	EP2SPA1215	\$854	\$904	\$924	\$944	+\$25	+\$49
18"	EP2SPA1815	\$878	\$928	\$948	\$968	+\$25	+\$49
24"	EP2SPA2415	\$902	\$952	\$982	\$1,002	+\$25	+\$49
30"	EP2SPA3015	\$926	\$976	\$1,016	\$1,036	+\$25	+\$49
36"	EP2SPA3615	\$950	\$1,010	\$1,050	\$1,070	+\$25	+\$49
42"	EP2SPA4215	\$974	\$1,034	\$1,084	\$1,104	+\$25	+\$49
48"	EP2SPA4815	\$986	\$1,056	\$1,116	\$1,136	+\$25	+\$49
60"	EP2SPA6015	\$1,010	\$1,110	\$1,170	\$1,200	+\$25	+\$49

Specify

1. Model #
2. Insert color
3. Paint

Assembly

- Included**
- Stack-on panel
 - Flat (N) top cap attached to the bottom of stack-on panel

Not Included

- Top cap
(use top cap from base panel)

Ordered Separately

- Stack-on posts
- Panel connectors

Stack-on Panels

Perforated Aluminum Insert with Slots

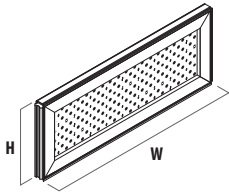

17" H

W	MODEL #	PA	INSERT PAINT			PAINT	
			P1	P2	P3	P2	P3
12"	EP2SPA1217	\$878	\$928	\$948	\$968	+ \$25	+ \$49
18"	EP2SPA1817	\$902	\$952	\$972	\$992	+ \$25	+ \$49
24"	EP2SPA2417	\$926	\$986	\$1,006	\$1,026	+ \$25	+ \$49
30"	EP2SPA3017	\$950	\$1,010	\$1,040	\$1,060	+ \$25	+ \$49
36"	EP2SPA3617	\$974	\$1,044	\$1,074	\$1,094	+ \$25	+ \$49
42"	EP2SPA4217	\$986	\$1,066	\$1,106	\$1,126	+ \$25	+ \$49
48"	EP2SPA4817	\$1,010	\$1,100	\$1,150	\$1,170	+ \$25	+ \$49
60"	EP2SPA6017	\$1,034	\$1,154	\$1,204	\$1,234	+ \$25	+ \$49

20" H

12"	EP2SPA1220	\$902	\$952	\$972	\$992	+ \$25	+ \$49
18"	EP2SPA1820	\$926	\$976	\$996	\$1,016	+ \$25	+ \$49
24"	EP2SPA2420	\$950	\$1,000	\$1,030	\$1,050	+ \$25	+ \$49
30"	EP2SPA3020	\$974	\$1,034	\$1,064	\$1,084	+ \$25	+ \$49
36"	EP2SPA3620	\$986	\$1,066	\$1,106	\$1,126	+ \$25	+ \$49
42"	EP2SPA4220	\$1,010	\$1,090	\$1,150	\$1,170	+ \$25	+ \$49
48"	EP2SPA4820	\$1,034	\$1,124	\$1,194	\$1,224	+ \$25	+ \$49
60"	EP2SPA6020	\$1,058	\$1,198	\$1,248	\$1,298	+ \$25	+ \$49

Insert Type		W	H
EP2S	Stack-on panel	36	15
PA	Perforated Aluminum	36	15

Pricing is for P1 paint colors. Add the appropriate upcharge if using P2 or P3 trim.

Stack-on Panels

Perforated Aluminum Insert without Slots

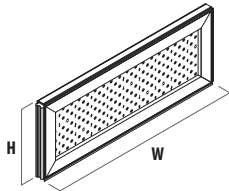

12" H

W	MODEL #	PA	INSERT PAINT			PAINT	
			P1	P2	P3	P2	P3
12"	EP2SPA1212N	\$781	\$831	\$851	\$871	+\$25	+\$49
18"	EP2SPA1812N	\$805	\$855	\$875	\$895	+\$25	+\$49
24"	EP2SPA2412N	\$841	\$891	\$911	\$931	+\$25	+\$49
30"	EP2SPA3012N	\$865	\$925	\$945	\$965	+\$25	+\$49
36"	EP2SPA3612N	\$889	\$949	\$969	\$989	+\$25	+\$49
42"	EP2SPA4212N	\$914	\$974	\$994	\$1,014	+\$25	+\$49
48"	EP2SPA4812N	\$938	\$998	\$1,018	\$1,038	+\$25	+\$49
60"	EP2SPA6012N	\$962	\$1,042	\$1,072	\$1,102	+\$25	+\$49

13" H

12"	EP2SPA1213N	\$830	\$880	\$900	\$920	+\$25	+\$49
18"	EP2SPA1813N	\$854	\$904	\$924	\$944	+\$25	+\$49
24"	EP2SPA2413N	\$878	\$938	\$958	\$978	+\$25	+\$49
30"	EP2SPA3013N	\$902	\$962	\$982	\$1,002	+\$25	+\$49
36"	EP2SPA3613N	\$926	\$986	\$1,006	\$1,026	+\$25	+\$49
42"	EP2SPA4213N	\$950	\$1,010	\$1,030	\$1,050	+\$25	+\$49
48"	EP2SPA4813N	\$974	\$1,034	\$1,054	\$1,084	+\$25	+\$49
60"	EP2SPA6013N	\$986	\$1,076	\$1,106	\$1,146	+\$25	+\$49

15" H

12"	EP2SPA1215N	\$854	\$904	\$924	\$944	+\$25	+\$49
18"	EP2SPA1815N	\$878	\$928	\$948	\$968	+\$25	+\$49
24"	EP2SPA2415N	\$902	\$952	\$982	\$1,002	+\$25	+\$49
30"	EP2SPA3015N	\$926	\$976	\$1,016	\$1,036	+\$25	+\$49
36"	EP2SPA3615N	\$950	\$1,010	\$1,050	\$1,070	+\$25	+\$49
42"	EP2SPA4215N	\$974	\$1,034	\$1,084	\$1,104	+\$25	+\$49
48"	EP2SPA4815N	\$986	\$1,056	\$1,116	\$1,136	+\$25	+\$49
60"	EP2SPA6015N	\$1,010	\$1,110	\$1,170	\$1,200	+\$25	+\$49

17" H

12"	EP2SPA1217N	\$878	\$928	\$948	\$968	+\$25	+\$49
18"	EP2SPA1817N	\$902	\$952	\$972	\$992	+\$25	+\$49
24"	EP2SPA2417N	\$926	\$986	\$1,006	\$1,026	+\$25	+\$49
30"	EP2SPA3017N	\$950	\$1,010	\$1,040	\$1,060	+\$25	+\$49
36"	EP2SPA3617N	\$974	\$1,044	\$1,074	\$1,094	+\$25	+\$49
42"	EP2SPA4217N	\$986	\$1,066	\$1,106	\$1,126	+\$25	+\$49
48"	EP2SPA4817N	\$1,010	\$1,100	\$1,150	\$1,170	+\$25	+\$49
60"	EP2SPA6017N	\$1,034	\$1,154	\$1,204	\$1,234	+\$25	+\$49

Specify

1. Model #
2. Insert color
3. Paint

Assembly

- Included**
- Stack-on panel
 - Flat (N) top cap attached to the bottom of stack-on panel

Not Included

- Top cap
(use top cap from base panel)

Ordered Separately

- Stack-on posts
- Panel connectors

Stack-on Panels

Perforated Aluminum Insert without Slots

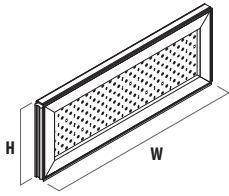

20" H

W	MODEL #	PA	INSERT PAINT			PAINT	
			P1	P2	P3	P2	P3
12"	EP2SPA1220N	\$902	\$952	\$972	\$992	+ \$25	+ \$49
18"	EP2SPA1820N	\$926	\$976	\$996	\$1,016	+ \$25	+ \$49
24"	EP2SPA2420N	\$950	\$1,000	\$1,030	\$1,050	+ \$25	+ \$49
30"	EP2SPA3020N	\$974	\$1,034	\$1,064	\$1,084	+ \$25	+ \$49
36"	EP2SPA3620N	\$986	\$1,066	\$1,106	\$1,126	+ \$25	+ \$49
42"	EP2SPA4220N	\$1,010	\$1,090	\$1,150	\$1,170	+ \$25	+ \$49
48"	EP2SPA4820N	\$1,034	\$1,124	\$1,194	\$1,224	+ \$25	+ \$49
60"	EP2SPA6020N	\$1,058	\$1,198	\$1,248	\$1,298	+ \$25	+ \$49

25" H

12"	EP2SPA1225N	\$938	\$988	\$1,008	\$1,028	+ \$25	+ \$49
18"	EP2SPA1825N	\$962	\$1,012	\$1,042	\$1,062	+ \$25	+ \$49
24"	EP2SPA2425N	\$986	\$1,046	\$1,076	\$1,096	+ \$25	+ \$49
30"	EP2SPA3025N	\$1,010	\$1,070	\$1,120	\$1,140	+ \$25	+ \$49
36"	EP2SPA3625N	\$1,034	\$1,104	\$1,164	\$1,184	+ \$25	+ \$49
42"	EP2SPA4225N	\$1,058	\$1,138	\$1,208	\$1,228	+ \$25	+ \$49
48"	EP2SPA4825N	\$1,095	\$1,185	\$1,255	\$1,285	+ \$25	+ \$49
60"	EP2SPA6025N	\$1,131	\$1,271	\$1,311	\$1,351	+ \$25	+ \$49

32" H

12"	EP2SPA1232N	\$962	\$1,012	\$1,032	\$1,052	+ \$25	+ \$49
18"	EP2SPA1832N	\$986	\$1,036	\$1,066	\$1,086	+ \$25	+ \$49
24"	EP2SPA2432N	\$1,010	\$1,070	\$1,100	\$1,120	+ \$25	+ \$49
30"	EP2SPA3032N	\$1,034	\$1,124	\$1,154	\$1,174	+ \$25	+ \$49
36"	EP2SPA3632N	\$1,058	\$1,168	\$1,208	\$1,228	+ \$25	+ \$49
42"	EP2SPA4232N	\$1,083	\$1,203	\$1,263	\$1,283	+ \$25	+ \$49
48"	EP2SPA4832N	\$1,119	\$1,239	\$1,319	\$1,339	+ \$25	+ \$49
60"	EP2SPA6032N	\$1,179	\$1,339	\$1,419	\$1,449	+ \$25	+ \$49

37" H

12"	EP2SPA1237N	\$986	\$1,036	\$1,056	\$1,076	+ \$25	+ \$49
18"	EP2SPA1837N	\$1,010	\$1,060	\$1,090	\$1,110	+ \$25	+ \$49
24"	EP2SPA2437N	\$1,034	\$1,094	\$1,124	\$1,154	+ \$25	+ \$49
30"	EP2SPA3037N	\$1,058	\$1,158	\$1,188	\$1,218	+ \$25	+ \$49
36"	EP2SPA3637N	\$1,083	\$1,213	\$1,243	\$1,283	+ \$25	+ \$49
42"	EP2SPA4237N	\$1,107	\$1,247	\$1,297	\$1,347	+ \$25	+ \$49
48"	EP2SPA4837N	\$1,143	\$1,293	\$1,353	\$1,413	+ \$25	+ \$49
60"	EP2SPA6037N	\$1,203	\$1,403	\$1,463	\$1,523	+ \$25	+ \$49

Insert Type		W	H	Slots
EP2S	Stack-on panel	36	15	N Without Slots
PA	Perforated Aluminum	36	15	N

Pricing is for P1 paint colors. Add the appropriate upcharge if using P2 or P3 trim.

Stack-on Posts



Standard

H	MODEL #	PAINT		
		P1	P2	P3
12"	EP1SPC12	\$150	\$155	\$160
13"	EP1SPC13	\$163	\$168	\$173
15"	EP1SPC15	\$174	\$179	\$184
17"	EP1SPC17	\$187	\$192	\$197
20"	EP1SPC20	\$211	\$221	\$231
25"	EP1SPC25	\$229	\$239	\$249
32"	EP1SPC32	\$242	\$252	\$262
37"	EP1SPC37	\$253	\$263	\$273

Panel connectors must be ordered separately.

Extended

12"	EP1SPC12E	\$150	\$155	\$160
13"	EP1SPC13E	\$163	\$168	\$173
15"	EP1SPC15E	\$174	\$179	\$184
17"	EP1SPC17E	\$187	\$192	\$197
20"	EP1SPC20E	\$211	\$221	\$231
25"	EP1SPC25E	\$229	\$239	\$249
32"	EP1SPC32E	\$242	\$252	\$262
37"	EP1SPC37E	\$253	\$263	\$273

Panel connectors must be ordered separately.

Specify

1. Model #
2. Paint

Application Notes

Stack-on post must be used between adjacent stack-on panels.

Standard Stack-on

Standard stack-on post bottom uses a conical shaped bolt that connects it to the connector directly beneath it. Panel connectors for the top of the stack-on post must be ordered separately to match the geometry of the stack-on panels.

Extended Stack-on

Extended stack-on post bottom uses a double-threaded round connector to attach to the full-height post directly beneath it. Multi-height panel connectors (**EPNPCMF**) must be used on either side of the bottom of this connector to provide a smooth transition. Standard panel connectors are used along the top of the stack-on panels.



Coat Hook Straight

DESCRIPTION	W	D	H	MODEL #	BLACK OR MATTE ALUM
5 Pack	1/8"	1 3/8"	2 3/8"	EP3MMCH (B/P)	\$170



Coat Hook Postless End

5 Pack	1 3/8"	3/8"	2 3/8"	EP3MMCHPE (R/L)(B/P)	\$170
--------	--------	------	--------	----------------------	-------

Specify

1. Model #
2. Paint

Coat Hook

Aluminum coat hook attaches to any exposed Equity vertical slot. There are two versions. The straight version will work on any Equity vertical slot except for those on an inside corner. The postless end version is handed and

extends beyond the edge of a panel with a postless end. Hand is determined by which side of the panel the coat hook is installed on while facing the panel.

Available in two colors

- Black (B)
- Matte Aluminum (P)

Frameless Glass

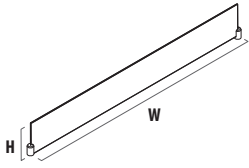

8" H

W	H	MODEL #	LIST
12"	8"	EPFLGL1208	\$169
18"	8"	EPFLGL1808	\$229
24"	8"	EPFLGL2408	\$290
30"	8"	EPFLGL3008	\$350
36"	8"	EPFLGL3608	\$411
42"	8"	EPFLGL4208	\$470
48"	8"	EPFLGL4808	\$531
60"	8"	EPFLGL6008	\$591
66"	8"	EPFLGL6608	\$652
72"	8"	EPFLGL7208	\$712

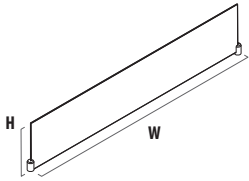

12" H

W	H	MODEL #	LIST
12"	12"	EPFLGL1212	\$229
18"	12"	EPFLGL1812	\$301
24"	12"	EPFLGL2412	\$374
30"	12"	EPFLGL3012	\$435
36"	12"	EPFLGL3612	\$495
42"	12"	EPFLGL4212	\$555
48"	12"	EPFLGL4812	\$615
60"	12"	EPFLGL6012	\$676
66"	12"	EPFLGL6612	\$736
72"	12"	EPFLGL7212	\$797

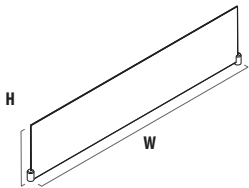

14" H

W	H	MODEL #	LIST
12"	14"	EPFLGL1214	\$266
18"	14"	EPFLGL1814	\$362
24"	14"	EPFLGL2414	\$459
30"	14"	EPFLGL3014	\$555
36"	14"	EPFLGL3614	\$652
42"	14"	EPFLGL4214	\$749
48"	14"	EPFLGL4814	\$845
60"	14"	EPFLGL6014	\$942
66"	14"	EPFLGL6614	\$1,038
72"	14"	EPFLGL7214	\$1,135

Specify

1. Model #
2. Glass finish

Glass Finishes

- CL . . Clear
- GR . . Grey
- SM . . Smoked
- TR . . Translucent

Application Notes

Glass is a single-pane, 3/8" tempered safety glass. Frameless glass can span multiple panels with one piece of glass.

Assembly

Not Included
• Attachment connectors

Top Cap		Type		W	H
EP	Equity Panel	FL	Frameless	48	12
EP		FL		48	12
		GL	Glass		

Frameless Connectors

DESCRIPTION	MODEL #	PAINT		
		P1	P2	P3
Straight	EPFLCS	\$72	\$78	\$85
2-way L	EPFLCL	\$78	\$85	\$92
3-way T	EPFLCT	\$78	\$85	\$92
3-way Y 120	EPFLCY	\$78	\$85	\$92
4-way X	EPFLCX	\$78	\$85	\$92
End	EPFLCE	\$72	\$78	\$85

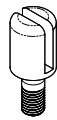

Straight
EPFLCS

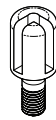

2-way L
EPFLCL

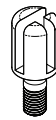

3-way T
EPFLCT

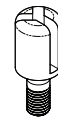

3-way Y 120
EPFLCY

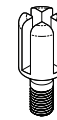

4-way X
EPFLCX

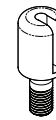

End
EPFLCE

Specify

1. Model #
2. Paint

Application Notes

Frameless glass mounts to panels on either end thru connectors that screw into the top of the panel's posts.

Assembly

Included
• Attachment hardware

Top Cap		Type		W			
EP	Equity Panel	FL	Frameless	C	Connector	S	Straight
						L	2-way L
						T	3-way T
						Y	3-way Y
						X	4-way X
						E	End
EP		FL		C		S	

Add-On Screens

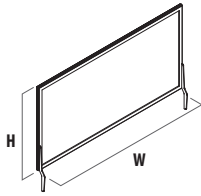

Add-on Screens

W	H	MODEL #	PAINT		
			P1	P2	P3
12"	15"	EP3AOPG1215	\$727	\$752	\$769
18"	15"	EP3AOPG1815	\$824	\$849	\$866
24"	15"	EP3AOPG2415	\$856	\$881	\$898
30"	15"	EP3AOPG3015	\$904	\$929	\$946
36"	15"	EP3AOPG3615	\$963	\$988	\$1,005
42"	15"	EP3AOPG4215	\$1,068	\$1,093	\$1,110
48"	15"	EP3AOPG4815	\$1,166	\$1,191	\$1,208
60"	15"	EP3AOPG6015	\$1,193	\$1,218	\$1,235

Specify

1. Model #
2. Plexiglass finish
3. Paint

Plexiglass Finishes

- CL** ... Clear
- IC** ... Ice
- SM** ... Smoked
- TR** ... Translucent
- LF** ... Frost

Application Notes

Add-on screens mount on the slotted standard with two (2) die cast stanchion brackets that are included.

Two add-on screens may not be mounted next to each other on the inside corner of a 90° connection.

Add-on screens are compatible with flat (N) and beveled (3) top caps.

Assembly

- Included**
- Attachment hardware

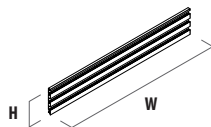

Slat Rail — panel mounted

W	H	MODEL #	MATTE ALUM	PAINT		
				P1	P2	P3
12"	6"	SR612	\$145	\$175	\$193	\$210
18"	6"	SR618	\$156	\$186	\$205	\$223
24"	6"	SR624	\$181	\$211	\$232	\$253
30"	6"	SR630	\$193	\$223	\$245	\$268
36"	6"	SR636	\$205	\$235	\$259	\$282
42"	6"	SR642	\$217	\$257	\$283	\$308
48"	6"	SR648	\$242	\$282	\$310	\$338
60"	6"	SR660	\$253	\$303	\$333	\$364

Slat Rail Accessories

W	H	D	MODEL #	DESCRIPTION	MATTE ALUM	PAINT		
						P1	P2	P3
12 ¼"	4"	2 ¾"	SRAFLH	File hanger	\$84	\$118	\$130	\$142
13 ¼"	7/8"	9 5/8"	SRAPAT	Paper tray	\$97	\$131	\$144	\$157
3 ¼"	3 ½"	1 ½"	SRAUPT	Upright tray	\$72	\$106	\$117	\$127
2 ¾"	7/8"	3 3/8"	SRASMT	Small tray	\$60	\$94	\$103	\$113
7 ¾"	7/8"	3 3/8"	SRAPNH	Pencil holder	\$60	\$94	\$103	\$113

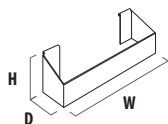

File Hanger
SRAFLH

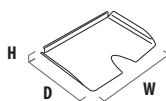

Paper Tray
SRAPAT

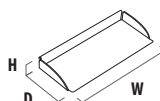

Pencil Holder
SRAPNH

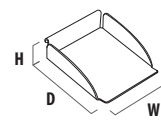

Small Tray
SRASMT

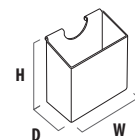

Upright Tray
SRAUPT

Specify

1. Model #
2. Paint

“E” Series electrical systems consist of a 4-circuit and a 6-circuit system. Each circuit in the systems provides a maximum of 20 amps. The four circuit system has eight wires; the six-circuit system has ten wires. Both 8- and 10-wire systems contain two 10-gauge “super” neutrals and two ground wires so that sensitive electronic equipment may be easily protected from unwanted electrical interference. “E” Series electrical can be connected to either single phase or three-phase building power supplies.

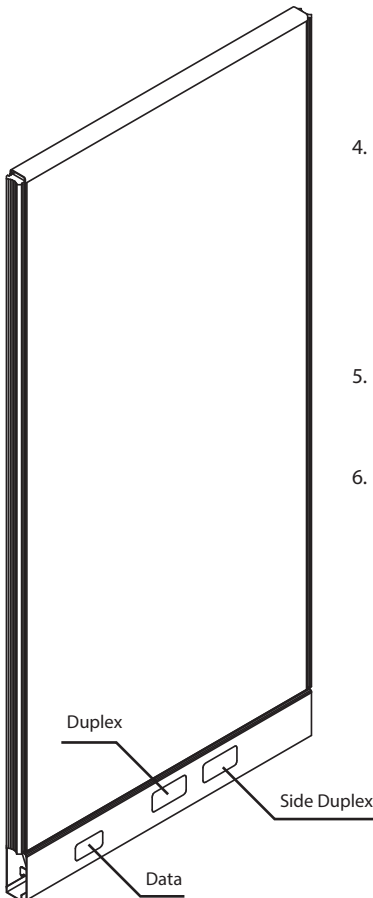

SPECIFICATION CHECKLIST

The following is a general checklist to ensure your order has been specified properly and to expedite entry of your order. It should be reviewed by a licensed electrician to ensure compliance with any local code requirements.

1. Base or ceiling infeed modules. One for each point of connection to the building power supply. Select model desired. Electrical connection to the building power supply must be made by a licensed electrician to ensure proper installation.
2. Select panels. Conduit jumpers are used to pass power to electrified panels. These panels do not have factory-installed power wiring, but modular power components are field-installed.
3. Shrouds must be used for each panel to panel point to complete the raceway connection. Shrouds are included when post assemblies are ordered. Shrouds can also be ordered separately when building a multiple height connection.
4. Duplex receptacles. Specify the circuit which receptacles are to access: #1, #2, #3 and #4D for 2+2 info eight-wire applications and additionally #5D and #6D for ten wire applications. If connecting to single-phase supply, do not order #2 and #5D receptacles.
5. Select and order appropriate conduit jumpers to pass power between panels.
6. Conduit Jumpers are for regular panel to panel connections or used to pass power through panels from terminal block to terminal block, which can be located up to 12 feet apart.

Calculate Correct Jumper Length

- 1) Add widths of both panels containing terminal blocks.
- 2) Divide by 2.
- 3) Add width of any non-electrified panels in-between. The result is the correct jumper length.

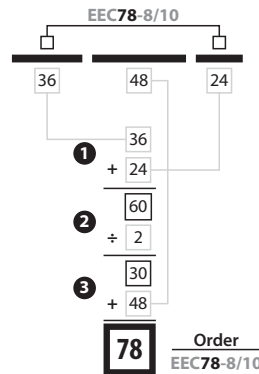

7. Modular wiring components. Internal panel wiring is fully modular and is field-installed into the raceway of panels. When wiring is field-installed the following components must be specified:

A. Terminal blocks

To branch circuits, splice jumpers or locate receptacles. Blocks snap-lock into place and are always located in the center of a panel. Panels have one block location only. Base infeed and ceiling infeed modules are each designed to plug into a terminal block, which must be ordered separately from the infeed.

B. Duplex Receptacles

Always specified separately according to circuit access.

C. Side Mount Receptacles

Available for panels 24" and wider. All standard receptacles fit into side mount position on right side of terminal block connector end. Therefore, no circuit number restriction.

SPECIAL CONSIDERATIONS

In addition to the checklist the following points should be remembered when planning a layout utilizing this electrical distribution system.

1. “E” Series electrical consists of four or six 20-amp circuits, any of which can be accessed as desired by plugging in a specially numbered receptacle at terminal block locations in panels.
2. Electrified panels can be interspersed between non-electrified panels with the use of extra-length jumpers which pass circuitry to the next electrified panel.
3. For isolation, the 2nd ground must be properly and separately grounded to the building by the installing licensed electrician.
4. Certain cities or localities carry special codes limiting the use of certain items within this system. Equity products are available which comply with these code requirements. Neutral Posture recommends contacting your local sales representative for clarification and possible restrictions.

Because of our continuous product improvements, these specifications are subject to change without notice. Please consult your sales representative for the latest information prior to ordering.

ELECTRICAL

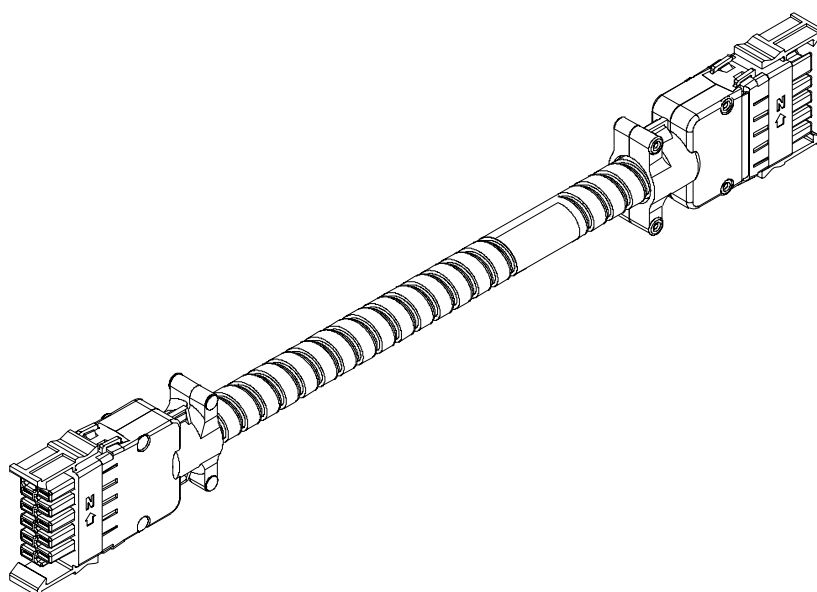

BASE INFEED MODULE

Modular base-mounted infeed conduits in eight-wire and ten-wire versions are provided for connection to building power supplies housed in underfloor outlet boxes, floor mounted (monuments) or wall outlet boxes. Available “unhanded” for ease in introducing power from left or right of infeed location. The cover plates provided by others, for floor monuments, recessed floor boxes or wall boxes are to be punched to receive a half-inch (trade size) knockout hole for installation of the box fitting, which is included on the infeed circuit. The wiring connection is to be made within the box inside the monument or behind the floor or wall flush plate. The 4' 6" conduit can be shortened to meet field conditions by cutting the infeed (loose) end. Base Infeed Module plugs into terminal block at the receptacle location. For New York and San Francisco base infeed, see page 63.

Connecting to the building power source must be performed by a licensed electrician.

CEILING INFEED MODULE

The straight tubular infeed may be shortened (on its bottom end) if it will not fit field conditions. ceiling infeed module is filled with 8- or 10- wire conduit and plugs into terminal block in adjacent panel. Harness length is 19'. Upper tube of module is 6' 7" in length.

RACEWAY PANELS WITH FIELD-INSTALLED COMPONENTRY:

1. An independent cableway with capacity for up to ten 3/8" dia. communications cables.
2. A terminal block at the center of the panel allows for jumpers to connect panel to panel electrical connections and placement of duplex receptacles.
3. Terminal block allows for receptacles in two locations, one on each side of the center of the panel (back to back), into which duplex 15-amp receptacles can be placed. The raceway covers are provided with removable knockouts.
4. For increased electric demands a second duplex receptacle per panel side can be added to panels 24" and wider. This receptacle plugs directly into the right side terminal block connector ends. Any standard “E” Series receptacle may be used.
5. The faceplates on both sides of the panel are removable without removing receptacles.

The system and all standard components are UL-listed. Because of our continuous product improvements, these specifications are subject to change without notice. Please consult a Neutral Posture sales representative for the latest information prior to ordering.

CABLE CAPACITY

FILL	100%	40%
Cat 5	35	14
Cat 6	28	11

8-WIRE SYSTEM

2 + 2

The 2+2 electrical system consists of four 20 amp, 120 volt, 60-Hertz circuits. These circuits will accommodate 120 volt single phase, 120/240 volt split phase and 120/208 volt three phase power. The system components have a 20 amp capacity. The (NEC) only allows steady loads to 80% of capacity which is equivalent to 16 amps. Each circuit can generally power 8 – 10 duplex convenience outlets that are performing a normal load. However, in heavy load situations, such as computer systems each circuit will power 3 – 5 duplex outlets.

3 + 1

The 3+1 electrical system consists of four 20 amp, 120 volt, 60-Hertz circuits. These circuits will power a 120 volt single phase, a 120/240 volt split and a 120/208 volt three phase power. Each system components have the capacity to power 20 amp. The National Electric Code (NEC) only allows steady loads to 80% of capacity which is equivalent to 16 amps. Each circuit can generally power 8-10 duplex convenience outlets that are performing a normal load. However, in heavy load situations, such as computer systems each circuit will power 3 – 5 duplex outlets. If each workstation has two convenience duplex outlets and one protected duplex, the 8-wire (4-circuit) system can supply a cluster of 6 – 10 workstations from each infeed.

10-WIRE SYSTEM

3 + 3

The 3+3 electrical system consists of six 20 amp, 120 volt, 60-Hertz circuits. The circuits will accommodate 120 volt single phase, 120/240 volt split phase and 120/208 volt three phase power. Each system components have the capacity to power 20 amp. The National Electric Code (NEC) only allows steady loads to 80% of capacity which is equivalent to 16 amps. Each circuit can generally power 8 – 10 duplex convenience outlets that are performing a normal load. However, in heavy load situations, such as computer systems each circuit will power 3 – 5 duplex outlets. If each workstation has two convenience duplex outlets and one protected duplex, the 10-wire (6-circuit) system can supply a cluster of 9 – 15 workstations from each infeed.

2 + 2

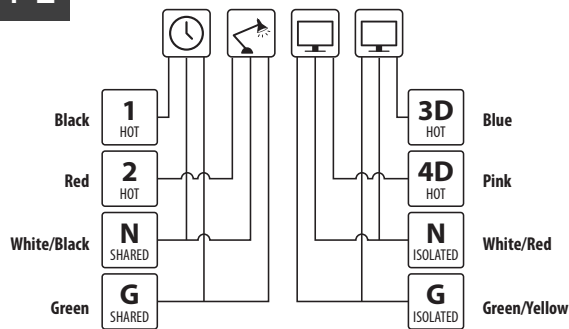

3 + 3

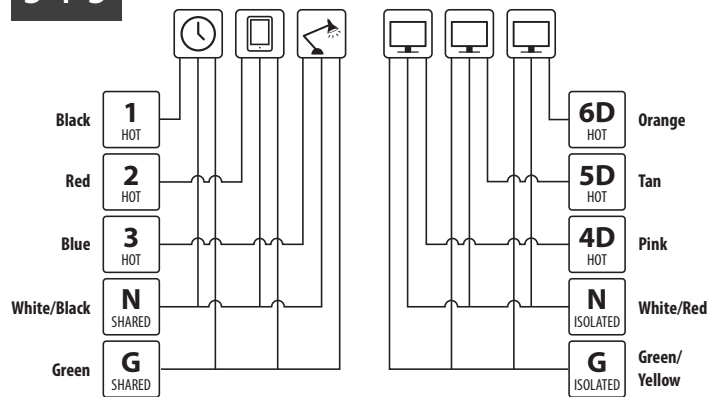

3 + 1

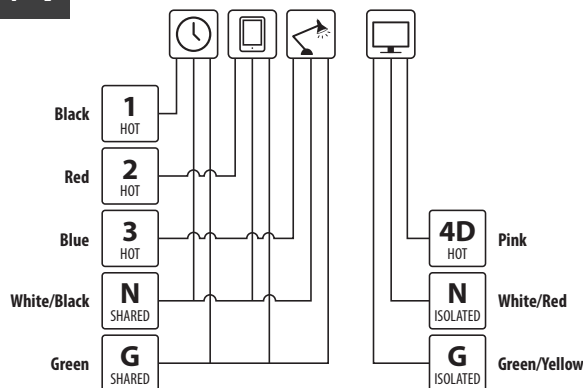

COMPATIBILITY

Equity power systems use similar components in all electrical systems. However, all parts are

not functionally interchangeable and should be used based on instructions given.



Ceiling Infeeds

W	D	H	MODEL #	PAINT		
				P1	P2	P3
4"	1 ½"	120"	EE3CM41M	\$718	\$754	\$792
4"	1 ½"	120"	EE3CM49M	\$718	\$754	\$792
4"	1 ½"	120"	EE3CM54M	\$718	\$754	\$792
4"	1 ½"	120"	EE3CM61M	\$718	\$754	\$792
4"	1 ½"	120"	EE3CM66M	\$718	\$754	\$792
4"	1 ½"	120"	EE3CM81M	\$718	\$754	\$792

Ceiling Infeed Harness

DESCRIPTION	MODEL #	LIST
E-Series 10-wire	EE1CH-10	\$658
E-Series 8-wire	EE1CH-8	\$540

Specify	Application Notes	Ceiling Infeeds
<p>1. Model #</p> <p>2. Paint</p> <p>Fabric cover modules are not available.</p> <p>Configurations</p> <p>8-wire 2 + 2 3 + 1</p> <p>10-wire 3 + 3</p>	<p>To connect a metal ceiling infeed to a corner or straight connection use an adjustable angle connector or an adjustable angle connector with multi-height connector for a three-way connection.</p>	<p>Electrical harnesses not included with modules. Modules are hollow to accommodate power and/or data cables from source into systems furniture.</p> <p>With electrical harness installed, infeed holds 28 Cat 6 cables.</p> <p>No "hang on" capabilities. Module cannot be used for panel support.</p> <p>Powder coated module is 120" long metal extrusion with attachment hooks at proper height to attach to appropriate height post.</p> <p>Cables/conduit are laid into module by removal of two-piece front 1 ½" wide vertical access cover which runs the length of the extrusion.</p> <p>Includes escutcheon plate which is white to integrate with ceiling. Tube is trim colored to match system trim.</p>

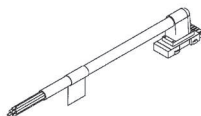

Base Infeeds

DESCRIPTION	W	MODEL #	LIST
8-wire (right handed)	54"	EE1BI-8	\$280
8-wire (right handed)	72"	EE1BI72-8	\$346
10-wire (right handed)	54"	EE1BI-10	\$339
10-wire (right handed)	72"	EE1BI72-10	\$411
8-wire (left handed)	54"	EE1BI-8-L	\$280
8-wire (left handed)	72"	EE1BI72-8-L	\$346
10-wire (left handed)	54"	EE1BI-10-L	\$339
10-wire (left handed)	72"	EE1BI72-10-L	\$411

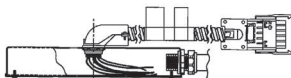

Base Infeeds – New York

10-wire	EE1BI-10N	\$426
8-wire	EE1BI-8N	\$349

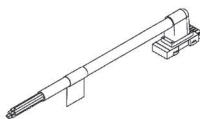

Base Infeeds – San Francisco

8-wire (non-handed)	54"	EE1BI-8SF	\$280
8-wire (non-handed)	72"	EE1BI72-8SF	\$346
10-wire (non-handed)	54"	EE1BI-10SF	\$339
10-wire (non-handed)	72"	EE1BI72-10SF	\$411

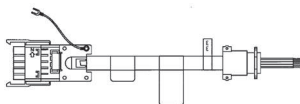

Jumper End Base Infeeds

10-wire (w/ground)	72"	EE1BIJ-10G	\$472
8-wire (w/ground)	72"	EE1BIJ-8G	\$391
8-wire	72"	EE1BIJ-8	\$359
10-wire	72"	EE1BIJ-10	\$443

Configurations

8-wire

2 + 2

3 + 1

10-wire

3 + 3

Base Infeeds

An infeed conduit connects to the wall or floor outlet box of a building's power supply and plugs into a terminal block in panel raceway. Power entry can be from either left or right side of panel. Metal cover conceals the baseboard connection and is reversible for either left or right entry. Can be field-cut to proper lengths. Color is black. A terminal block must be ordered separately.

Jumper End Base Infeeds

Connects by hardwiring to a building's electrical supply in floor or wall box by a licensed electrician. Plugs into one set of terminal connections at end of terminal block. Terminal block must be located in panel adjacent to source. Terminal block is ordered separately. Base infeed can be field cut by a licensed electrician to necessary length. Conduit is encased in black plastic sealer.



Terminal Block

DESCRIPTION	MODEL #	8-WIRE		10-WIRE	LIST
		(3+1)	(2+2)	(3+3)	
8-wire	EE1TB8	•	•		\$64
10-wire	EE1TB10			•	\$82



Duplex Receptacle

DESCRIPTION	MODEL #	8-WIRE		10-WIRE	LIST
		(3+1)	(2+2)	(3+3)	
Circuit #1	EE1R1	•	•	•	\$57
Circuit #2	EE1R2	•	•	•	\$57
Circuit #3 dedicated for 2+2	EE1R3D		•		\$57
Circuit #3 for 3+1	EE1R3	•		•	\$57
Circuit #4 dedicated circuit for 3+1, 2+2 or 3+3	EE1R4D	•	•	•	\$57
Circuit #5 dedicated circuit for 3+3	EE1R5D			•	\$57
Circuit #6 dedicated circuit for 3+3	EE1R6D			•	\$57



Duplex Receptacle (10 Pack)

DESCRIPTION	MODEL #	8-WIRE		10-WIRE	LIST
		(3+1)	(2+2)	(3+3)	
Circuit #1	EE1R1 P10	•	•	•	\$472
Circuit #2	EE1R2 P10	•	•	•	\$472
Circuit #3 dedicated for 2+2	EE1R3D P10		•		\$472
Circuit #3 for 3+1	EE1R3 P10	•		•	\$472
Circuit #4 dedicated circuit for 3+1, 2+2 or 3+3	EE1R4D P10	•	•	•	\$472
Circuit #5 dedicated circuit for 3+3	EE1R5D P10			•	\$472
Circuit #6 dedicated circuit for 3+3	EE1R6D P10			•	\$472

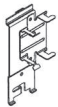

Receptacle – Side Mount

DESCRIPTION	MODEL #	8-WIRE		10-WIRE	LIST
		(3+1)	(2+2)	(3+3)	
10 Pack	EE1SMRB10	•	•	•	\$287

Data Shield

DESCRIPTION	MODEL #	8-WIRE		10-WIRE	LIST
		(3+1)	(2+2)	(3+3)	
Terminal block shield	EE15BR	•	•	•	\$88



Knock-out Replacement Cover

DESCRIPTION	MODEL #	LIST
10 Pack	EE1KC10	\$78

Application Notes

Receptacles are black only.

Terminal Block

A modular eight or ten wire block that snaps into the base location in center of the panel. Used to branch circuits, splice jumpers or locate duplex receptacles back to back.

Side Mount Receptacles

Plugs directly into the right side of terminal block to provide a second duplex receptacle where required.

Any "E" Series receptacle can be used in panels 24" wide and wider. Side mount receptacle bracket (**EE1SMRB10**) is needed when using a side mount receptacle.

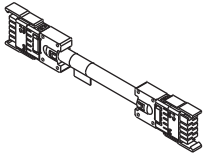

Jumper

LENGTH (NOMINAL)	LENGTH (ACTUAL)	MODEL #	8-WIRE	10-WIRE
18"	11 1/2"	EE1C18-(8/10)	\$125	\$148
21"	14 1/2"	EE1C21-(8/10)	\$129	\$151
24"	17 1/2"	EE1C24-(8/10)	\$133	\$155
27"	20 1/2"	EE1C27-(8/10)	\$134	\$165
30"	23 1/2"	EE1C30-(8/10)	\$138	\$167
33"	26 1/2"	EE1C33-(8/10)	\$141	\$174
36"	29 1/2"	EE1C36-(8/10)	\$142	\$177
39"	32 1/2"	EE1C39-(8/10)	\$149	\$185
42"	35 1/2"	EE1C42-(8/10)	\$152	\$190
45"	38 1/2"	EE1C45-(8/10)	\$156	\$193
48"	41 1/2"	EE1C48-(8/10)	\$162	\$195
51"	44 1/2"	EE1C51-(8/10)	\$167	\$204
54"	47 1/2"	EE1C54-(8/10)	\$167	\$204
57"	50 1/2"	EE1C57-(8/10)	\$177	\$212
60"	53 1/2"	EE1C60-(8/10)	\$180	\$218
63"	56 1/2"	EE1C63-(8/10)	\$186	\$221
66"	59 1/2"	EE1C66-(8/10)	\$189	\$231
69"	62 1/2"	EE1C69-(8/10)	\$189	\$231
72"	65 1/2"	EE1C72-(8/10)	\$195	\$238
75"	68 1/2"	EE1C75-(8/10)	\$197	\$241
78"	71 1/2"	EE1C78-(8/10)	\$200	\$248
81"	74 1/2"	EE1C81-(8/10)	\$203	\$249
84"	77 1/2"	EE1C84-(8/10)	\$204	\$251
87"	80 1/2"	EE1C87-(8/10)	\$213	\$263
90"	83 1/2"	EE1C90-(8/10)	\$218	\$266
93"	86 1/2"	EE1C93-(8/10)	\$220	\$270
96"	89 1/2"	EE1C96-(8/10)	\$228	\$277
99"	92 1/2"	EE1C99-(8/10)	\$232	\$280
102"	95 1/2"	EE1C102-(8/10)	\$235	\$286
105"	98 1/2"	EE1C105-(8/10)	\$238	\$290
108"	101 1/2"	EE1C108-(8/10)	\$239	\$292
111"	104 1/2"	EE1C111-(8/10)	\$248	\$297
114"	107 1/2"	EE1C114-(8/10)	\$253	\$305
120"	113 1/2"	EE1C120-(8/10)	\$264	\$319
126"	119 1/2"	EE1C126-(8/10)	\$269	\$325
132"	125 1/2"	EE1C132-(8/10)	\$273	\$335
144"	137 1/2"	EE1C144-(8/10)	\$290	\$353

Configurations

8-wire

2 + 2

3 + 1

10-wire

3 + 3

Application Notes

Jumpers transmit power circuits from one panel mounted terminal block to another. Can carry power through panels where no terminal blocks are installed. The length of the jumper corresponds to the distance between the terminal blocks.

Calculate the Correct Length

1. Add widths of both panels containing terminal blocks.
2. Divide by two.
3. Add width of any non-electrified panels in-between.

The result is the correct jumper length.

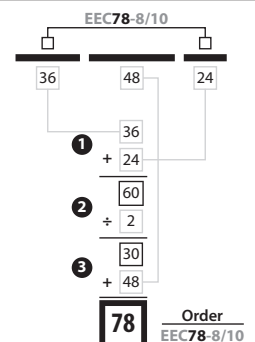

Electrical

Dedicated Neutral System Components



Terminal Block

MODEL #	LIST
EE1TB-(N3/N4)	\$82



Duplex Receptacles

EE1RIIIN	\$66
EE1RIIN	\$66
EE1RIN	\$66
EE1RIVN	\$66



Duplex Receptacles (10 pack)

EE1RIIIN P10	\$502
EE1RIIN P10	\$502
EE1RIN P10	\$502
EE1RIVN P10	\$502

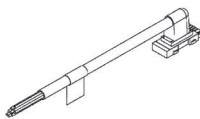

Base Infeeds

NOMINAL LENGTH	MODEL #	LIST
54"	EE1BI-(N3/N4)	\$358
72"	EE1BI72-(N3/N4)	\$379

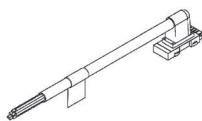

Base Infeeds – San Francisco

54"	EE1BI-(N3/N4)SF	\$358
72"	EE1BI72-(N3/N4)SF	\$379

Ceiling Infeed Harness

DESCRIPTION	MODEL #	LIST
E-Series 8-wire	EE1CH-N3	\$785
E-Series 10-wire	EE1CH-N4	\$939

Specification Information

8-wire N3

8-wire N3 = 2+1 system (2 hots and 2 neutrals sharing one ground, 1 isolated hot and 1 isolated neutral on an isolated ground)

10-wire N4

10-wire N4 = 2+2 system (2 hots and 2 neutrals sharing one ground, 2 hots and 2 neutrals sharing another ground)

Application Notes

Jumpers

Transmit power circuits from one panel mounted terminal block to another. Can carry power through panels where no terminal blocks are installed. The length of the jumper corresponds to the distance between the terminal blocks.

Calculate the Correct Length

1. Add widths of both panels containing terminal blocks.
2. Divide by two.
3. Add width of any non-electrified panels in-between.

The result is the correct jumper length.

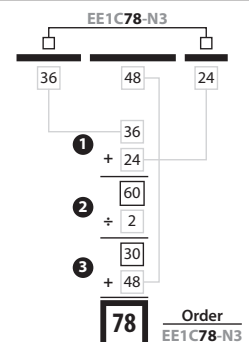

Jumper

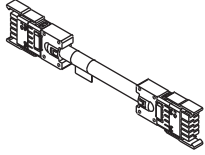

NOMINAL LENGTH	MODEL #	LIST
18"	EE1C18-(N3/N4)	\$152
21"	EE1C21-(N3/N4)	\$162
24"	EE1C24-(N3/N4)	\$166
27"	EE1C27-(N3/N4)	\$174
30"	EE1C30-(N3/N4)	\$180
33"	EE1C33-(N3/N4)	\$185
36"	EE1C36-(N3/N4)	\$186
39"	EE1C39-(N3/N4)	\$192
42"	EE1C42-(N3/N4)	\$200
45"	EE1C45-(N3/N4)	\$204
48"	EE1C48-(N3/N4)	\$205
51"	EE1C51-(N3/N4)	\$215
54"	EE1C54-(N3/N4)	\$215
57"	EE1C57-(N3/N4)	\$221
60"	EE1C60-(N3/N4)	\$232
63"	EE1C63-(N3/N4)	\$236
66"	EE1C66-(N3/N4)	\$239
69"	EE1C69-(N3/N4)	\$239
72"	EE1C72-(N3/N4)	\$251
75"	EE1C75-(N3/N4)	\$256
78"	EE1C78-(N3/N4)	\$261
81"	EE1C81-(N3/N4)	\$264
84"	EE1C84-(N3/N4)	\$266
87"	EE1C87-(N3/N4)	\$277
90"	EE1C90-(N3/N4)	\$280
93"	EE1C93-(N3/N4)	\$284
96"	EE1C96-(N3/N4)	\$290
99"	EE1C99-(N3/N4)	\$293
102"	EE1C102-(N3/N4)	\$297
105"	EE1C105-(N3/N4)	\$305
108"	EE1C108-(N3/N4)	\$307
111"	EE1C111-(N3/N4)	\$318
114"	EE1C114-(N3/N4)	\$322
120"	EE1C120-(N3/N4)	\$336
126"	EE1C126-(N3/N4)	\$342
132"	EE1C132-(N3/N4)	\$350
144"	EE1C144-(N3/N4)	\$370

Specification Information

8-wire N3

8-wire N3 = 2+1 system (2 hots and 2 neutrals sharing one ground, 1 isolated hot and 1 isolated neutral on an isolated ground)

10-wire N4

10-wire N4 = 2+2 system (2 hots and 2 neutrals sharing one ground, 2 hots and 2 neutrals sharing another ground)

Application Notes

Jumpers

Transmit power circuits from one panel mounted terminal block to another. Can carry power through panels where no terminal blocks are installed. The length of the jumper corresponds to the distance between the terminal blocks.

Calculate the Correct Length

1. Add widths of both panels containing terminal blocks.
2. Divide by two.
3. Add width of any non-electrified panels in-between.

The result is the correct jumper length.

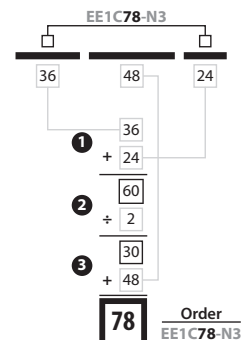

Charge Spot

DESCRIPTION	MODEL #	LIST
Wireless device charger	AWDC1	\$516
Wireless device charger (4 Pack) w/multi unit power supply	AWDC4	\$1,747

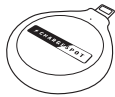

Charge Spot Dongles

Apple Lightning dongle	AWDCSA	\$92
mUSB dongle	AWDCSU	\$92

Charge Spot Replacement Power

Single unit power supply	AWDCRPS1	\$68
Multi unit power supply	AWDCRPS4	\$310

Ashley Duo



DESCRIPTION	W	D	H	MODEL #	LIST
72" Cord length	5 1/2"	3 1/8"	2"	EE4WSAD72	\$437
120" Cord length	5 1/2"	3 1/8"	2"	EE4WSAD120	\$448

Ashley Duo Air



In-surface pop-up power	7"	5"		EPUPM72	\$571
In-surface pop-up power	7"	5"		EPUPM120	\$583

Ashley 202

Clamp

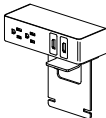

72" cord length	5 1/2"	3 1/8"	2"	EE4WSA202CM72	\$410
120" cord length	5 1/2"	3 1/8"	2"	EE4WSA202CM120	\$422

Under Worksurface



72" cord length	5 1/2"	3 1/8"	2"	EE4WSA202UW72	\$353
120" cord length	5 1/2"	3 1/8"	2"	EE4WSA202UW120	\$364

In Surface

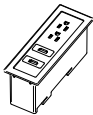

72" cord length	5 1/2"	3 1/8"	2"	EE4WSA202IS72	\$410
120" cord length	5 1/2"	3 1/8"	2"	EE4WSA202IS120	\$422

Specify

1. Model #

Specify Ashley Duo

2. Model #
3. Metal trim finish
4. Plastic finish
5. For Hardwired add **HW** to end of model number and add **\$85** to list price

Ashley Duo

Specifications

- 2 - 15A, 120V AC Power Outlets
- 2 - 2.1A/10.5W USB Charging Ports
- 6' or 10' Cord and Hardwire Options
- Meets USB.org Battery Charging 1.2 Specifications
- Accommodates surfaces 1" to 1 3/4" thick.

Data Wiring

Data wiring and keystones provided by customer's cabling contractor.

Ashley Trio

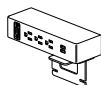

Clamp

72" cord length	8"	3 7/8"	2"	EE4WSATRIOCM72	\$873
120" cord length	8"	3 7/8"	2"	EE4WSATRIOCM120	\$903



Under Worksurface

72" cord length	8"	3 7/8"	2"	EE4WSATRIOUW72	\$783
120" cord length	8"	3 7/8"	2"	EE4WSATRIOUW120	\$813



In Surface

72" cord length	8 7/8"	3 7/8"	2"	EE4WSATRIOIS72	\$837
120" cord length	8 7/8"	3 7/8"	2"	EE4WSATRIOIS120	\$867

Ashley Quad

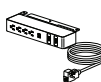

Under Worksurface

4 AC outlets, 2 USB, 2 Data	10 7/8"	3 7/8"	1 3/4"	EE4UWSAQ2D72	\$755
4 AC outlets, 2 USB, 2 Data	10 7/8"	3 7/8"	1 3/4"	EE4UWSAQ2D120	\$778



In Surface

4 AC outlets, 2 USB, 2 Data	10 7/8"	3 7/8"	1 3/4"	EE4ISAQ2D72	\$859
4 AC outlets, 2 USB, 2 Data	10 7/8"	3 7/8"	1 3/4"	EE4ISAQ2D120	\$882

Desktop Power



108" Cord length	3 3/4"	4 1/2"	EE4WSME108	\$189
72" Cord length	3 3/4"	4 1/2"	EE4WSME72	\$213

Desktop Data



	3 3/4"	2 1/2"	5"	EE4WSMC	\$160
--	--------	--------	----	----------------	-------

Desktop Power & Data



108" Cord length	EE4WSMED108	\$419
72" Cord length	EE4WSMED72	\$457

Specify Ashley

1. Model #
2. Metal trim finish
3. Plastic finish
4. For Hardwired add **HW** to end of model number and add **\$85** to list price.

Ashley 202

Specifications

- 2 - 15A, 120V AC Power Outlets
- 2 Data Inserts for HDMI, RJ45, RJ11, VGA or Blank Insert
- 6' or 10' Cord or Hardwire Option
- Accommodates surfaces 1" to 1 3/4" thick.

Ashley Trio

Specifications

- 3- 15A, 120V AC Power Outlets
- 2- 2.1A/10.5W USB Charging Ports
- 6' or 10' Cord or Hardwire Option
- 1 Data Insert for HDMI, RJ45 or VGA ports
- 1 Data Port Adapter Kit Comes Standard

Ashley Quad

Specifications

- 4 - 15A, 120V AC Power Outlets
- 2- 2.1A/10.5W USB Charging Ports
- 2 Data Inserts for HDMI, RJ45, RJ11, VGA or Blank Insert
- 6' or 10' Cord or Hardwire Option

Metal Trim Finishes

- MBLK**Black
- MWHT**White
- MSIL**Silver

Plastic Finishes

- PBLK**Black
- PWHT**White
- PSIL**Silver

Worksurfaces

General Info

Step 1 – Model

Worksurface Type			Options						
W	D	Wiring			Extended Ends				
EW1	Rectangle	48	24	G	Grommets	\$25	E	One End	\$21
				G2	Scallop	\$50	EE	Both Ends	\$42
EW1		48	24	G			E		

Step 2 – Surface Finish

Laminate	
PW-STK	Studio Teak
PW-STK	

Step 3 – Edge Finish

Edge Band	
EB-STK	Studio Teak
EB-STK	

FEATURES

DEPTHS

20"
24"
30"
36"

WIDTHS

24"
30"
36"
42"
48"
54"
60"
66"
72"
78"
84"
90"
96"
102"
108"
114"
120"

THICKNESS

1 1/8"

WIRING & CABLING

GROMMET

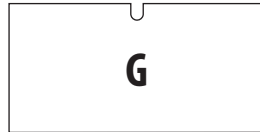

When a standard grommet is specified it is in a rear, centered location and is available in black only. Corner worksurfaces provide two edge grommets.

SCALLOP



Scalloped grommets feature additional half grommets on either end to provide a full grommet when two tops meet. The half grommet also allows for cord management by itself when it is wrapped by panels and not adjacent to other worksurfaces.

CABLE DROP

3/8" Cable management gap

EDGE DETAIL

STANDARD

3mm ABS

WOODGRAIN

2mm PVC

SURFACE MATERIALS

STANDARD WORKSURFACE

High pressure laminate

CASCADE WORKSURFACE

Thermafoil (available on Cascade edge only)

EDGE BAND

Available matching or contrasting. Upcharge may be applicable.

SUPPORTS

Under worksurface — black powdercoat
Countercap supports — paint

WORKSURFACES

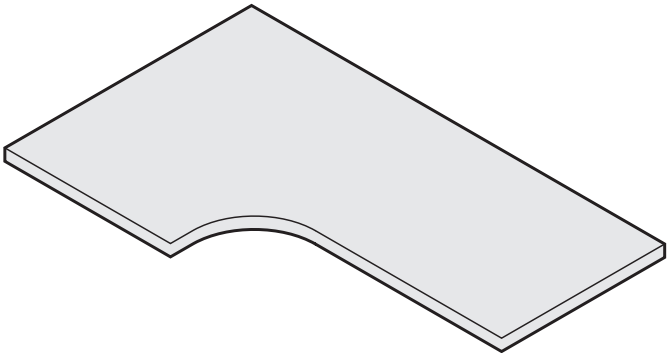

Worksurface

General Information

Top surface available in standard laminates. For a complete list of color offering consult the Finishes page (page 14) at the beginning of the price list.

Underside of all 24" deep and deeper rectangular worksurfaces are predrilled for mounting of support bracketry.

The front edge of 30" deep cantilevered surfaces should not be loaded in excess of 180 pounds.

Worksurfaces are designed to provide a 3/8" cable management gap between the back edge of the worksurface and wall panel.

D & P TOPS

Equity "D" and "P" tops are actual depth plus 1 1/2" to cover two posts and may not be panel wrapped. This allows an adjustable bar support to support the flat end without being visually obtrusive. Adjacent worksurfaces should be specified so as not to cover a post where a "D" or "P" top may be used.

WORKSURFACE DIMENSIONS

Equity is measured from the center of the posts on each end of the panel. A standard worksurface is dimensioned to fit in a fully panel wrapped configuration. It is therefore 1 1/2" narrower than the nominal panel dimension. If you would like the worksurface to extend to cover one post you will need to add an "E" to the worksurface item number. This will add 1 1/2" to the width of the surface. If you would like the worksurface to extend to cover both posts then you will need to add "EE", extending the surface by 3" from the standard. Adjustable height work surfaces, page 88, are 2" narrower than a standard surface to meet anti-pinch point requirements around their perimeter.

E ... Covers 1 post
EE ... Covers 2 posts

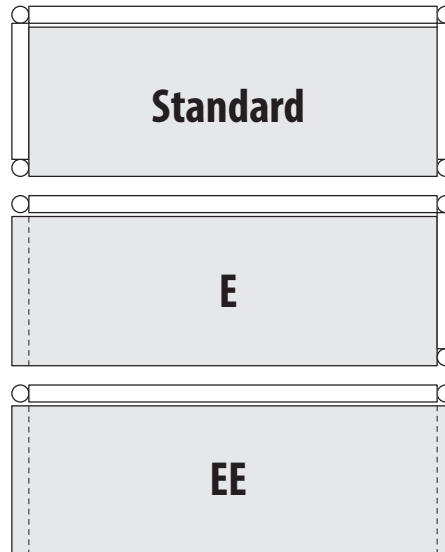

24" DEEP STRAIGHTS & 15" TOWERS

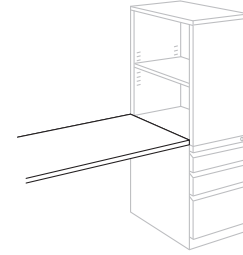

When adding a 15" tower to the end of a worksurface you will need to add a "T" to the end of the model number in order to make the worksurface and tower completely flush. This will only be necessary on 24" deep worksurfaces with a width from 48" – 84".

(T) – Available on

W	H	W (actual)	
48"	24"	43 1/4"	EW14824T
54"	24"	49 1/4"	EW15424T
60"	24"	55 1/4"	EW16024T
66"	24"	61 1/4"	EW16624T
72"	24"	67 1/4"	EW17224T
78"	24"	73 1/4"	EW17824T
84"	24"	79 1/4"	EW18424T

MOUNTING CORNER WORKSURFACES

USING ALL CANTILEVERS

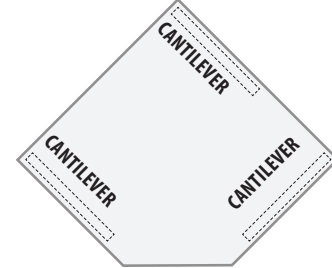

USING 2 CANTILEVERS AND 1 PANEL TO WORKSURFACE BRACKET

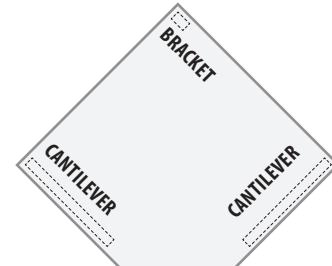

Worksurface Sizes		Cantilever-C		Adjustable Bar Support-S		Supporting Pedestal	Supporting Pedestal
W	D	EB1C20(L/R)		EB1SR(S/L)		24" Deep	30" Deep
24"	20"	200 lbs	2C	200 lbs	2S	N/A	N/A
24"	24"	200 lbs	2C	200 lbs	2S	+1 Support	N/A
30"	20"	200 lbs	2C	200 lbs	2S	N/A	N/A
30"	24"	200 lbs	2C	200 lbs	2S	+1 Support	N/A
30"	30"	200 lbs	2C	200 lbs	2S	—	+1 Support
36"	20"	200 lbs	2C	200 lbs	2S	N/A	N/A
36"	24"	200 lbs	2C	200 lbs	2S	+1 Support	N/A
36"	30"	200 lbs	2C	200 lbs	2S	—	+1 Support
42"	20"	200 lbs	2C	200 lbs	2S	N/A	N/A
42"	24"	200 lbs	2C	200 lbs	2S	+1 Support	N/A
42"	30"	200 lbs	2C	200 lbs	2S	—	+1 Support
48"	20"	216 lbs	2C	216 lbs	2S	N/A	N/A
48"	24"	216 lbs	2C	216 lbs	2S	+1 Support	N/A
48"	30"	216 lbs	2C	216 lbs	2S	—	+1 Support
54"	20"	243 lbs	3C	243 lbs	2S/1C	N/A	N/A
54"	24"	243 lbs	3C	243 lbs	2S/1C	+2 Support	N/A
54"	30"	243 lbs	3C	243 lbs	2S/1C	—	+2 Support
60"	20"	270 lbs	3C	270 lbs	2S/1C	N/A	N/A
60"	24"	270 lbs	3C	270 lbs	2S/1C	+2 Support	N/A
60"	30"	270 lbs	3C	270 lbs	2S/1C	—	+2 Support
66"	20"	297 lbs	3C	297 lbs	2S/1C	N/A	N/A
66"	24"	297 lbs	3C	297 lbs	2S/1C	+2 Support	N/A
66"	30"	297 lbs	3C	297 lbs	2S/1C	—	+2 Support
72"	20"	324 lbs	3C	324 lbs	2S/1C	N/A	N/A
72"	24"	324 lbs	3C	324 lbs	2S/1C	+2 Support	N/A
72"	30"	324 lbs	3C	324 lbs	2S/1C	—	+2 Support
78"	20"	351 lbs	3C	351 lbs	2S/1C	N/A	N/A
78"	24"	351 lbs	3C	351 lbs	2S/1C	+2 Support	N/A
84"	20"	378 lbs	3C	378 lbs	2S/1C	N/A	N/A
84"	24"	378 lbs	3C	378 lbs	2S/1C	+2 Support	N/A
84"	30"	—	—	378 lbs	2S/1C	—	+2 Support
90"	20"	405 lbs	3C	405 lbs	2S/1C	N/A	N/A
90"	24"	405 lbs	3C	405 lbs	2S/1C	+2 Support	N/A
96"	20"	432 lbs	3C	432 lbs	2S/1C	N/A	N/A
96"	24"	432 lbs	3C	432 lbs	2S/1C	+2 Support	N/A
96"	30"	—	—	432 lbs	2S/2C	—	+2 Support
108"	20"	486 lbs	4C	486 lbs	2S/2C	N/A	N/A
108"	24"	486 lbs	4C	486 lbs	2S/2C	+3 Support	N/A
108"	30"	—	—	486 lbs	2S/2C	—	+3 Support
120"	20"	540 lbs	4C	540 lbs	2S/2C	N/A	N/A
120"	24"	540 lbs	4C	540 lbs	2S/2C	+3 Support	N/A
120"	30"	—	—	540 lbs	2S/2C	—	+3 Support

- Support must be installed for every four feet of width. As indicated, 5' worksurfaces require three supports; two panels are required to install the center support.
- The applications shown in the table emphasize the fundamentals of worksurface loading and support. As long as these criteria are met, supports can be interchanged.
- Supporting drawer pedestals can replace only one support.
- Depth of stretchered worksurfaces must be equal to or less than side panel widths.
- Stretchered worksurfaces should be used where heavy loading is anticipated.
- Cantilevers cannot be used as primary support for 36" deep surfaces or 30" deep surfaces wider than 72".
- The front edge of 30" deep surfaces should not be loaded in excess of 180 pounds.

Weights listed are the Business Institutional Furniture Manufacturers Association (BIFMA) functional load requirements for panel hung worksurface loading. If loads larger than these listed are anticipated, approval from Neutral Posture is required.

INSTALLATIONS WHICH VIOLATE THESE REQUIREMENTS WILL NOT BE COVERED BY THE NEUTRAL POSTURE WARRANTY.

Rectangle



Blended Corner



Corner Round



Corner

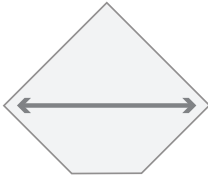
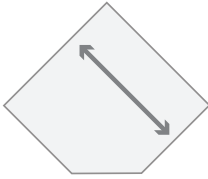
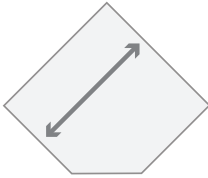

Blended Peninsula

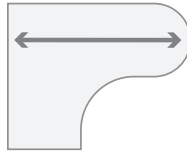

D Top



Blended Double Corner



P/9 Tops

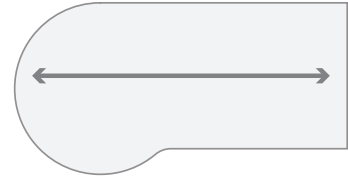

135° Curved Cluster

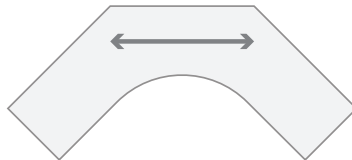

Half Round



W3

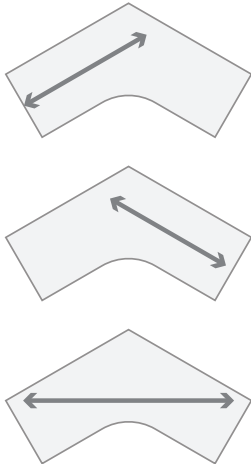

W6

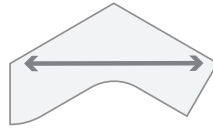

W13

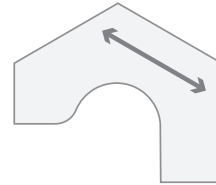

W7

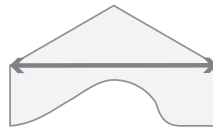

T3



W4

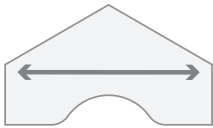

W11

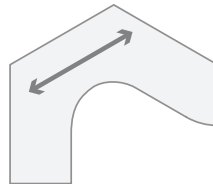

T4



W5

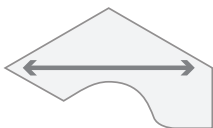

W12

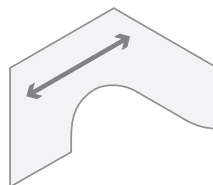

T5



Worksurfaces

Straights

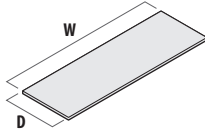

20" Deep

W	D	HA AVAILABLE	MODEL #	LAMINATE		
				L1	L2	L3
24"	20"		EW12420	\$391	\$430	\$469
30"	20"		EW13020	\$423	\$465	\$507
36"	20"		EW13620	\$460	\$506	\$552
42"	20"		EW14220	\$492	\$541	\$590
48"	20"		EW14820	\$530	\$583	\$636
54"	20"		EW15420	\$561	\$617	\$673
60"	20"		EW16020	\$600	\$660	\$720
66"	20"		EW16620	\$631	\$694	\$757
72"	20"		EW17220	\$644	\$708	\$772
78"	20"		EW17820	\$669	\$735	\$802
84"	20"		EW18420	\$707	\$777	\$848
90"	20"		EW19020	\$738	\$811	\$885
96"	20"		EW19620	\$776	\$853	\$931
102"	20"		EW110220	\$808	\$888	\$969
108"	20"		EW110820	\$846	\$930	\$1,015
114"	20"		EW111420	\$878	\$965	\$1,053
120"	20"		EW112020	\$915	\$1,006	\$1,098

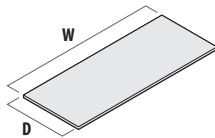

24" Deep

W	D	HA AVAILABLE	MODEL #	L1	L2	L3
24"	24"		EW12424	\$429	\$471	\$514
30"	24"		EW13024	\$454	\$499	\$544
36"	24"		EW13624	\$480	\$528	\$576
42"	24"	•	EW14224	\$505	\$555	\$606
48"	24"	•	EW14824	\$530	\$583	\$636
54"	24"	•	EW15424	\$568	\$624	\$681
60"	24"	•	EW16024	\$637	\$700	\$764
66"	24"	•	EW16624	\$701	\$771	\$841
72"	24"	•	EW17224	\$713	\$784	\$855
78"	24"		EW17824	\$733	\$806	\$879
84"	24"		EW18424	\$745	\$819	\$894
90"	24"		EW19024	\$758	\$833	\$909
96"	24"		EW19624	\$802	\$882	\$962
102"	24"		EW110224	\$846	\$930	\$1,015
108"	24"		EW110824	\$878	\$965	\$1,053
114"	24"		EW111424	\$915	\$1,006	\$1,098
120"	24"		EW112024	\$947	\$1,041	\$1,136

24" DEEP STRAIGHTS & 15" TOWERS



When adding a 15" tower to the end of a work surface you will need to add a "T" to the end of the model number in order to make the work surface and tower completely flush. This will only be necessary on 24" deep work surfaces with a width from 48" – 84".

EW1	Rectangle	W	D	Options								
				Wiring			Extended Ends		Height Adjustable			
		48	24	G	Grommet	\$30	E	One End	\$26	HA	4 HAT Supports	\$0
				G2	Scallop	\$62	EE	Both Ends	\$52			
EW1		48	24	G			E			HA		

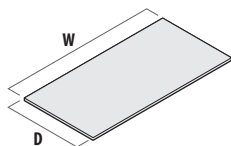

30" Deep

W	D	HA AVAILABLE	MODEL #	LAMINATE		
				L1	L2	L3
24"	30"		EW12430	\$492	\$541	\$590
30"	30"		EW13030	\$530	\$583	\$636
36"	30"		EW13630	\$561	\$617	\$673
42"	30"	•	EW14230	\$600	\$660	\$720
48"	30"	•	EW14830	\$618	\$679	\$741
54"	30"	•	EW15430	\$719	\$790	\$862
60"	30"	•	EW16030	\$776	\$853	\$931
66"	30"	•	EW16630	\$827	\$909	\$992
72"	30"	•	EW17230	\$871	\$958	\$1,045
78"	30"		EW17830	\$896	\$985	\$1,075
84"	30"		EW18430	\$947	\$1,041	\$1,136
90"	30"		EW19030	\$997	\$1,096	\$1,196
96"	30"		EW19630	\$1,029	\$1,131	\$1,234
102"	30"		EW110230	\$1,137	\$1,250	\$1,364
108"	30"		EW110830	\$1,193	\$1,312	\$1,431
114"	30"		EW111430	\$1,238	\$1,361	\$1,485
120"	30"		EW112030	\$1,289	\$1,417	\$1,546

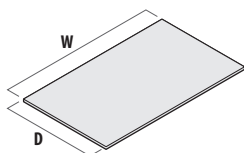

36" Deep

W	D	HA AVAILABLE	MODEL #	LAMINATE		
				L1	L2	L3
48"	36"		EW14836	\$859	\$944	\$1,030
54"	36"		EW15436	\$890	\$979	\$1,068
60"	36"		EW16036	\$928	\$1,020	\$1,113
66"	36"		EW16636	\$979	\$1,076	\$1,174
72"	36"		EW17236	\$1,048	\$1,152	\$1,257
78"	36"		EW17836	\$1,105	\$1,215	\$1,326
84"	36"		EW18436	\$1,137	\$1,250	\$1,364
90"	36"		EW19036	\$1,193	\$1,312	\$1,431
96"	36"		EW19636	\$1,263	\$1,389	\$1,515
102"	36"		EW110236	\$1,333	\$1,466	\$1,599
108"	36"		EW110836	\$1,408	\$1,548	\$1,689
114"	36"		EW111436	\$1,484	\$1,632	\$1,780
120"	36"		EW112036	\$1,547	\$1,701	\$1,856

Specify

1. Model #
2. Options
3. Laminate
4. Edge band

Grain Direction

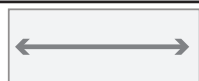

Wiring & Cabling



Grommet \$30



Scallop \$62

Support Information

All supports must be ordered separately. See page 84 – 85.

Worksurface Loading & Support

See page 73.

A center support must be used with a 54" wide or wider worksurface.

Worksurfaces

Corners

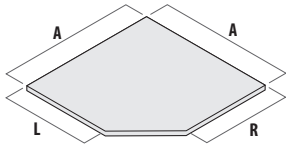

Straight Front

				LAMINATE		
A	L	R	MODEL #	L1	L2	L3
36"	20"	20"	EW1C3620	\$713	\$784	\$855
36"	24"	24"	EW1C3624	\$713	\$784	\$855
36"	30"	30"	EW1C3630	\$802	\$882	\$962
42"	20"	20"	EW1C4220	\$903	\$993	\$1,083
42"	24"	24"	EW1C4224	\$903	\$993	\$1,083
42"	30"	30"	EW1C4230	\$979	\$1,076	\$1,174
48"	20"	20"	EW1C4820	\$1,080	\$1,188	\$1,296
48"	24"	24"	EW1C4824	\$1,080	\$1,188	\$1,296
48"	30"	30"	EW1C4830	\$1,099	\$1,208	\$1,318

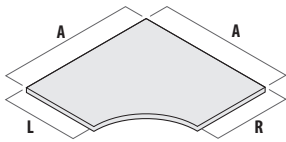

Curved Front

A	L	R	MODEL #	L1	L2	L3
36"	24"	24"	EW1CC3624	\$783	\$861	\$939
42"	24"	24"	EW1CC4224	\$997	\$1,096	\$1,196
48"	24"	24"	EW1CC4824	\$1,188	\$1,306	\$1,425
60"	24"	24"	EW1CC6024	\$1,326	\$1,458	\$1,591

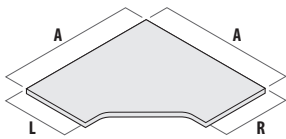

Corner with Cutout

A	L	R	MODEL #	L1	L2	L3
48"	24"	24"	EW1C4824K	\$1,073	\$1,180	\$1,287

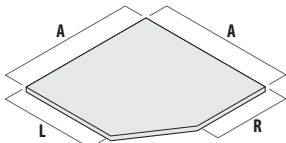

Different Returns

A	L	R	MODEL #	L1	L2	L3
36"	24"	30"	EW1C362430	\$960	\$1,056	\$1,152
36"	30"	24"	EW1C363024	\$960	\$1,056	\$1,152
42"	24"	30"	EW1C422430	\$1,080	\$1,188	\$1,296
42"	30"	24"	EW1C423024	\$1,080	\$1,188	\$1,296
48"	24"	30"	EW1C482430	\$1,193	\$1,312	\$1,431
48"	30"	24"	EW1C483024	\$1,193	\$1,312	\$1,431

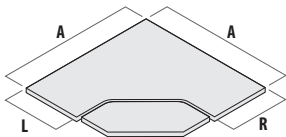

Split Corner — all hardware included

				LAMINATE			PAINT (CANTILEVERS ONLY)	
A	L	R	MODEL #	L1	L2	L3	P2	P3
36"	24"	24"	EW1SC3624	\$2,381	\$2,619	\$2,857	+\$18	+\$37
42"	24"	24"	EW1SC4224	\$2,445	\$2,689	\$2,934	+\$18	+\$37
42"	30"	30"	EW1SC4230	\$2,482	\$2,730	\$2,978	+\$18	+\$37
48"	24"	24"	EW1SC4824	\$2,583	\$2,841	\$3,099	+\$18	+\$37
48"	30"	30"	EW1SC4830	\$2,755	\$3,030	\$3,306	+\$18	+\$37

Paint option is for cantilevers only. All other hardware is only available in black.

Specify

1. Model #
2. Options
3. Laminate
4. Edge band
5. Grain direction

Grain Direction

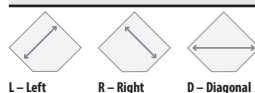

Insert the desired direction after the laminate finish code.

NOTE: Add \$30 to list price for diagonal grain (D).

Wiring & Cabling

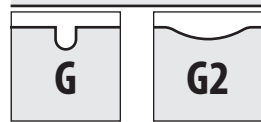

Grommet \$30 Scallop \$62

Application Notes

A return panel may not be used next to corner worksurfaces, as they cover both posts for a smooth transition with adjacent rectangular worksurfaces.

Support Information

All supports must be ordered separately. See page 84 – 85.

Worksurface Loading & Support
See page 73.

A center support must be used with a 54" wide or wider worksurface.

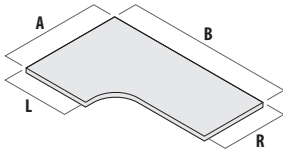

Right Hand

L	A	B	R	HA AVAILABLE	MODEL #	LAMINATE		
						L1	L2	L3
24"	36"	60"	24"		EW1BS3660S(X/L/R/B)	\$1,067	\$1,173	\$1,280
24"	48"	60"	24"	•	EW1BS4860S(X/L/R/B)	\$1,092	\$1,201	\$1,310
24"	48"	66"	24"	•	EW1BS4866S(X/L/R/B)	\$1,124	\$1,236	\$1,348
24"	36"	72"	24"	•	EW1BS3672S(X/L/R/B)	\$1,124	\$1,236	\$1,348
24"	48"	72"	24"	•	EW1BS4872S(X/L/R/B)	\$1,174	\$1,291	\$1,408
24"	48"	60"	30"		EW1BS4860D(X/L/R/B)	\$1,124	\$1,236	\$1,348
24"	48"	66"	30"		EW1BS4866D(X/L/R/B)	\$1,149	\$1,263	\$1,378
24"	48"	72"	30"		EW1BS4872D(X/L/R/B)	\$1,218	\$1,339	\$1,461
30"	48"	60"	24"		EW1BD4860S(X/L/R/B)	\$1,124	\$1,236	\$1,348
30"	48"	66"	24"		EW1BD4866S(X/L/R/B)	\$1,130	\$1,243	\$1,356
30"	48"	72"	24"		EW1BD4872S(X/L/R/B)	\$1,188	\$1,306	\$1,425

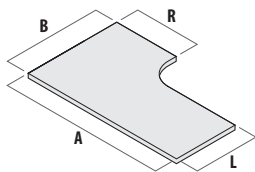

Left Hand

24"	60"	36"	24"		EW1BS6036S(X/L/R/B)	\$1,067	\$1,173	\$1,280
24"	60"	48"	24"	•	EW1BS6048S(X/L/R/B)	\$1,099	\$1,208	\$1,318
24"	66"	48"	24"	•	EW1BS6648S(X/L/R/B)	\$1,124	\$1,236	\$1,348
24"	72"	36"	24"	•	EW1BS7236S(X/L/R/B)	\$1,130	\$1,243	\$1,356
24"	72"	48"	24"	•	EW1BS7248S(X/L/R/B)	\$1,174	\$1,291	\$1,408
24"	60"	48"	30"		EW1BS6048D(X/L/R/B)	\$1,099	\$1,208	\$1,318
24"	66"	48"	30"		EW1BS6648D(X/L/R/B)	\$1,124	\$1,236	\$1,348
24"	72"	48"	30"		EW1BS7248D(X/L/R/B)	\$1,188	\$1,306	\$1,425
30"	60"	48"	24"		EW1BD6048S(X/L/R/B)	\$1,099	\$1,208	\$1,318
30"	66"	48"	24"		EW1BD6648S(X/L/R/B)	\$1,149	\$1,263	\$1,378
30"	72"	48"	24"		EW1BD7248S(X/L/R/B)	\$1,218	\$1,339	\$1,461

EW1B Blended Worksurface	L	A	B	R	Posts Covered	Options	
						Wiring	Height Adj.
EW1B	S 24	36	72	S 24	X No posts covered	G Grommet \$30	HA 4 HAT Supports
	D 30			D 30	L Left side post covered R Right side post covered B Both side posts covered	G2 Scallop \$62	
	S	36	72	S	X	G	HA

Specify

1. Model #
2. Options
3. Laminate
4. Edge band

Grain Direction

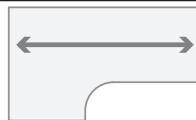

Wiring & Cabling

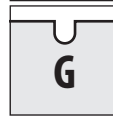

Grommet \$30



Scallop \$62

Application Notes

Blended worksurfaces are designed to take the place of two adjacent worksurfaces by blending them into one top. The front of the worksurface is curved to provide a smooth transition to the next attached worksurface.

Support Information

All supports must be ordered separately. See page 84.

Worksurface Loading & Support

See page 73.

A center support must be used with a 54" wide or wider worksurface.

Worksurfaces

Corner Peninsulas

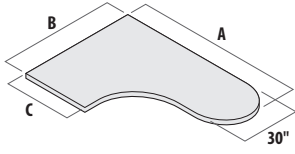

Right Hand

A	B	C	MODEL #	LAMINATE		
				L1	L2	L3
60"	48"	24"	EW1BP6048SR	\$1,231	\$1,354	\$1,477
72"	48"	24"	EW1BP7248SR	\$1,257	\$1,382	\$1,508
72"	48"	30"	EW1BP7248DR	\$1,289	\$1,417	\$1,546
78"	48"	24"	EW1BP7848SR	\$1,314	\$1,445	\$1,576
78"	48"	30"	EW1BP7848DR	\$1,314	\$1,445	\$1,576
84"	48"	24"	EW1BP8448SR	\$1,547	\$1,701	\$1,856
84"	48"	30"	EW1BP8448DR	\$1,579	\$1,736	\$1,894

Left Hand

60"	48"	24"	EW1BP6048SL	\$1,231	\$1,354	\$1,477
72"	48"	24"	EW1BP7248SL	\$1,257	\$1,382	\$1,508
72"	48"	30"	EW1BP7248DL	\$1,289	\$1,417	\$1,546
78"	48"	24"	EW1BP7848SL	\$1,314	\$1,445	\$1,576
78"	48"	30"	EW1BP7848DL	\$1,314	\$1,445	\$1,576
84"	48"	24"	EW1BP8448SL	\$1,547	\$1,701	\$1,856
84"	48"	30"	EW1BP8448DL	\$1,579	\$1,736	\$1,894

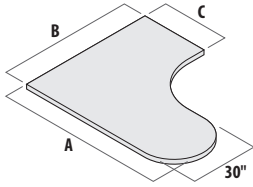

Worksurfaces

	A	B	C	Posts Covered
EW1BP Blended Peninsula	36	72	S 24" Deep D 30" Deep	L Left side post covered R Right side post covered
EW1BP	36	72	S	L

Specify

1. Model #
2. Options
3. Laminate
4. Edge band

Grain Direction

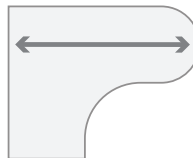

Grommet

Blended peninsulas do not come with a grommet. Due to this, if the worksurface adjacent to the "C" side is ordered with scallops there will be a one-half scallop where the return meets the peninsula.

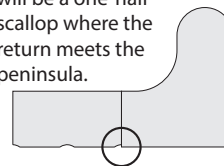

Support Information

All supports must be ordered separately. See page 84 – 85.

Worksurface Loading & Support

See page 73.
Center support must be used for all surfaces which exceed 48" in length.

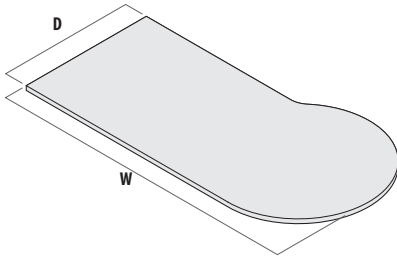
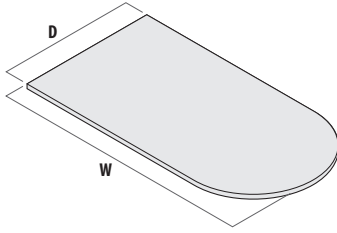

D Peninsula

W	D	MODEL #	LAMINATE		
			L1	L2	L3
60"	30"	EW1D6030	\$694	\$763	\$832
72"	30"	EW1D7230	\$1,206	\$1,326	\$1,447
72"	36"	EW1D7236	\$1,408	\$1,548	\$1,689
84"	30"	EW1D8430	\$1,579	\$1,736	\$1,894
84"	36"	EW1D8436	\$1,756	\$1,931	\$2,107

9 & P Peninsula

72"	30"	EW1(9/P)7230	\$1,206	\$1,326	\$1,447
72"	36"	EW1(9/P)7236	\$1,408	\$1,548	\$1,689
84"	30"	EW1(9/P)8430	\$1,579	\$1,736	\$1,894
84"	36"	EW1(9/P)8436	\$1,756	\$1,931	\$2,107

		W	D
EW1D	D Peninsula	72	30
EW19	9 Peninsula		
EW1P	P Peninsula		
EW1BP		72	30

Specify

1. Model #
2. Options
3. Laminate
4. Edge band

Grain Direction

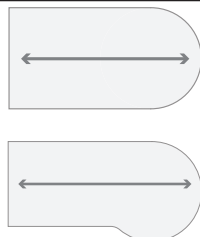

Application Notes

Designed for use as primary worksurfaces and for conferencing in small groups.

NOTE: P and D worksurfaces cannot be panel wrapped.

Support Information

Column bases and adjustable bar supports must be ordered separately. See page 84 – 85.

Worksurface Loading & Support
See page 73.

84" wide D, P and 9 worksurfaces include a V support bar mounted on the underside for additional stability.

Worksurfaces

Half-Round & Linking

Worksurfaces



Half Round without Notch

W	D	MODEL #	LAMINATE		
			L1	L2	L3
48"	30"	EW1HR4830	\$940	\$1,034	\$1,128
60"	36"	EW1HR6036	\$1,180	\$1,298	\$1,416

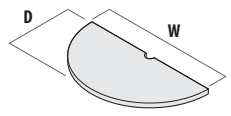

Half Round with Notch

W	D	MODEL #	L1	L2	L3
48"	30"	EW1HR4830N	\$940	\$1,034	\$1,128
60"	36"	EW1HR6036N	\$1,180	\$1,298	\$1,416



Quarter Round

D	MODEL #	L1	L2	L3
24"	EW1CR24	\$423	\$465	\$507
30"	EW1CR30	\$460	\$506	\$552

				Options	
		W	D	Notch	
EW1HR	Half Round	36	72	N	Round Notch
EW1HR		36	72	N	

Specify	Grain Direction	Half Round Without Notches	Half Round With Notches	Support Information
<ol style="list-style-type: none"> 1. Model # 2. Options 3. Laminate 4. Edge band 		<p>Half rounds without notches attach to panels by means of an adjustable bar support and are supported by column bases, available in standard trim colors. Column is fixed height.</p>	<p>Included</p> <ul style="list-style-type: none"> • Splice plates <p>Not Included nor Required</p> <ul style="list-style-type: none"> • Bar support 	<p>All supports must be ordered separately. See page 84 – 85.</p> <p>Worksurface Loading & Support See page 73.</p>

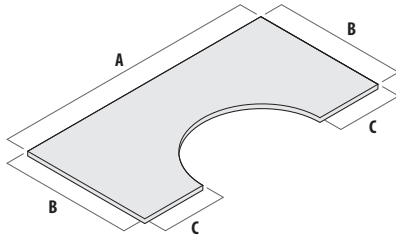

Blended Double Corner

A	B	C	MODEL #	LAMINATE		
				L1	L2	L3
96"	48"	24"	EW1BC9648	\$1,579	\$1,736	\$1,894

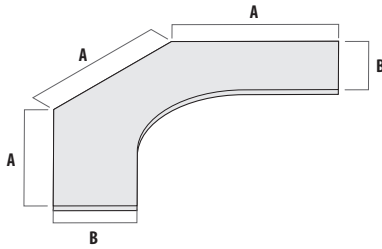

135° Curved Cluster

A	B	MODEL #	L1	L2	L3
36"	24"	EW11353624	\$1,158	\$1,273	\$1,389
42"	24"	EW11354224	\$1,446	\$1,590	\$1,735
48"	24"	EW11354824	\$1,663	\$1,829	\$1,995

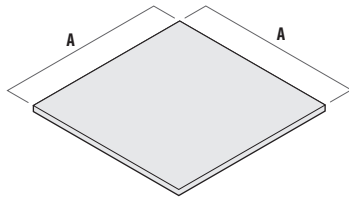

135° Cluster Core

A	MODEL #	L1	L2	L3
36"	EW1135C36	\$739	\$812	\$886
42"	EW1135C42	\$817	\$898	\$980
48"	EW1135C48	\$897	\$986	\$1,076

Specify

1. Model #
2. Options
3. Laminate
4. Edge band

Grain Direction

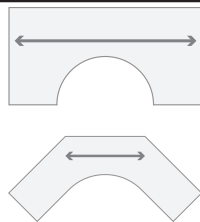

Double Corner

Double corner work surface is designed to take the place of two adjacent corners by combining them into one top.

48" deep sides are designed to cover a post and cannot be panel wrapped.

135° Curved Cluster

Used in 135° planning configurations.

Support Information

All supports must be ordered separately. See page 84 – 85.

Worksurface Loading & Support
See page 73.

Wiring & Cabling



Grommet \$30



Scallop \$62

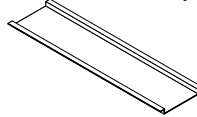
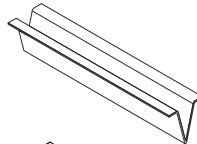
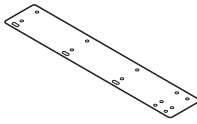
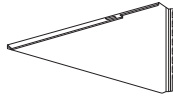
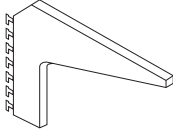

Cantilever

DESCRIPTION	D	MODEL #	BLACK	PAINT		
				P1	P2	P3
Left hand	20"	EB1C20L	\$108	\$181	\$199	\$217
Left hand (10 pack)	20"	EB1C20L10	\$845	\$1,208	\$1,329	\$1,450
Right hand	20"	EB1C20R	\$108	\$181	\$199	\$217
Right hand (10 pack)	20"	EB1C20R10	\$845	\$1,208	\$1,329	\$1,450

120 Cantilever

Left hand 60°	18"	EB3C18L60	\$110	\$183	\$201	\$220
Left hand 90°	18"	EB3C18L90	\$110	\$183	\$201	\$220
Right hand 60°	18"	EB3C18R60	\$110	\$183	\$201	\$220
Right hand 90°	18"	EB3C18R90	\$110	\$183	\$201	\$220

Splice Plate

20" Flat bracket (20" & 24" tops)	EB1F24	\$54	N/A	N/A	N/A
26" Flat bracket (30" & 36" tops)	EB1F30	\$62	N/A	N/A	N/A
Alignment plate	EB1APW	\$17	N/A	N/A	N/A

Bracket

Panel to worksurface bracket	EB1PWS(L/R)	\$18	\$60	\$66	\$72
Panel to worksurface bracket (Pair – L/R)	EB1PWSP	\$35	\$108	\$119	\$130

V Channel Support

54"	VS54	\$150	N/A	N/A	N/A
100"	VS100	\$290	N/A	N/A	N/A

Worksurface Support Rail

ACTUAL WIDTH	MAX WORKSURFACE WIDTH				
46"	60"	WSR46	\$97	N/A	N/A
57"	72"	WSR57	\$114	N/A	N/A

Cantilevers

Worksurface cantilevers lock into panel slotted standards at 1" increments. Cantilevers are handed.

Panel to Worksurface Bracket

Can be specified in lieu of cantilever when worksurface is same depth as adjacent panel.

A single bracket can be specified behind a pedestal to secure adjacent panel to worksurface.

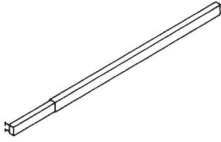

Adjustable Bar Support

DESCRIPTION	MODEL #	BLACK	PAINT		
			P1	P2	P3
24", 30" and 36"	EB1SR5	\$242	\$301	\$331	\$361
24", 30" and 36" (10 pack)	EB1SR510	\$2,294	\$2,898	\$3,188	\$3,478
42", 48" and 60"	EB1SRL	\$271	\$332	\$365	\$398
42", 48" and 60" (10 pack)	EB1SRL10	\$2,415	\$3,140	\$3,454	\$3,768

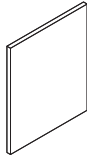

Desk End Panels

H	W	MODEL #	LAMINATE		
			L1	L2	L3
29"	20"	EB1DEP20	\$739	\$813	\$887
29"	24"	EB1DEP24	\$754	\$829	\$905
29"	30"	EB1DEP30	\$798	\$878	\$957

Specify

1. Model #
2. Paint

Adjustable Bar Support

Adjustable bar supports position in the slotted standards at 1" increments. Two sizes of adjustable bar supports are available. Small adjustable bar support fits 24" through 36" wide panels; the larger adjustable bar support fits 42" through 60" wide panels. All have keyhole slots to mount worksurfaces and are non-handed.



Column Bases

DESCRIPTION	H	MODEL #	PAINT		
			P1	P2	P3
Fixed height support column	27 ¾"	EB1FCOL	\$386	\$420	\$436



Tapered Legs

Single leg	27 ¾"	TBTL	\$422	\$462	\$502
Single leg w/caster	27 ¾"	TBTL C	\$453	\$493	\$533
Set of 2	27 ¾"	TBTL2	\$725	\$794	\$863
Set of 2 w/casters	27 ¾"	TBTL2C	\$784	\$853	\$922
Set of 4	27 ¾"	TBTL4	\$1,388	\$1,520	\$1,652
Set of 4 w/casters	27 ¾"	TBTL4C	\$1,509	\$1,641	\$1,773
Bar height single leg	40 ½"	TBTLBH	\$953	\$1,068	\$1,183
Bar height set of 2	40 ½"	TBTLBH2	\$1,811	\$2,156	\$2,242
Bar height set of 4	40 ½"	TBTLBH4	\$3,260	\$3,605	\$4,065

Round Legs

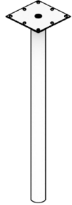

Single leg	27 ¾"	TBRL	\$235.00	\$275	\$315
Single leg w/caster	27 ¾"	TBRL C	\$265.00	\$305	\$345
Set of 2	27 ¾"	TBRL2	\$403.00	\$443	\$483
Set of 2 w/casters	27 ¾"	TBRL2C	\$463.00	\$503	\$543
Set of 4	27 ¾"	TBRL4	\$776.00	\$816	\$856
Set of 4 w/casters	27 ¾"	TBRL4C	\$896.00	\$936	\$976

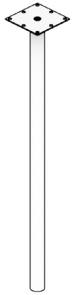

Round Legs — (Bar Height)

Single leg	40 ¾"	TBRLBH	\$422	\$462	\$502
Single leg w/caster	40 ¾"	TBRLBHC	\$453	\$493	\$533
Set of 2	40 ¾"	TBRLBH2	\$725	\$794	\$863
Set of 2 w/casters	40 ¾"	TBRLBH2C	\$784	\$853	\$922
Set of 4	40 ¾"	TBRLBH4	\$1,388	\$1,520	\$1,652
Set of 4 w/casters	40 ¾"	TBRLBH4C	\$1,509	\$1,641	\$1,773

Specify

1. Model #
2. Paint

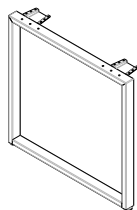

O Legs

DESCRIPTION	H	MODEL #	PAINT		
			P1	P2	P3
24" Deep	27 3/4"	TBOLL24	\$720	\$792	\$864
30" Deep	27 3/4"	TBOLL30	\$733	\$806	\$880
24" Deep (set of 2)	27 3/4"	TBOLL242	\$1,421	\$1,563	\$1,705
30" Deep (set of 2)	27 3/4"	TBOLL302	\$1,445	\$1,590	\$1,734

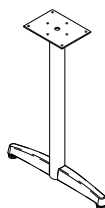

T Legs

20" Deep	27 3/4"	TBTLL20	\$406	\$447	\$487
26" Deep	27 3/4"	TBTLL26	\$419	\$461	\$503
36" Deep	27 3/4"	TBTLL36	\$443	\$487	\$532
42" Deep	27 3/4"	TBTLL42	\$540	\$594	\$648
48" Deep	27 3/4"	TBTLL48	\$636	\$700	\$763
20" Deep (set of 2)	27 3/4"	TBTLL202	\$793	\$872	\$952
26" Deep (set of 2)	27 3/4"	TBTLL262	\$817	\$899	\$980
36" Deep (set of 2)	27 3/4"	TBTLL362	\$865	\$952	\$1,038
42" Deep (set of 2)	27 3/4"	TBTLL422	\$1,058	\$1,164	\$1,270
48" Deep (set of 2)	27 3/4"	TBTLL482	\$1,240	\$1,364	\$1,488

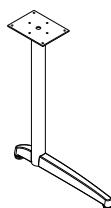

C Legs

20" Deep	27 3/4"	TBCLL20	\$406	\$447	\$487
26" Deep	27 3/4"	TBCLL26	\$419	\$461	\$503
32" Deep	27 3/4"	TBCLL32	\$443	\$487	\$532
20" Deep (set of 2)	27 3/4"	TBCLL202	\$793	\$872	\$952
26" Deep (set of 2)	27 3/4"	TBCLL262	\$817	\$899	\$980
32" Deep (set of 2)	27 3/4"	TBCLL322	\$878	\$966	\$1,054

Specify

1. Model #
2. Paint

Levelers

Adjustable height levelers are included at no additional cost on all models.

Shank Length

C & T-Legs — 3/8-16 x 3/4"
O-Legs — 3/8-16 x 2"

Leveler extensions can be ordered separately. Please contact Customer Service for information on ordering leveler extensions. Casters can be ordered in place of levelers for an upcharge on most standard height tables.

Height Adjustable Worksurfaces

Worksurface for Height Adjustable Supports

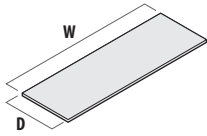

Worksurface Only 24"

For Height Adjustable Supports

W	D	MODEL #	LAMINATE			WOOD VENEER		
			L1	L2	L3	W1	W2	W3
42"	24"	EAW14224WS	\$505	\$555	\$606	\$1,011	\$1,112	\$1,213
48"	24"	EAW14824WS	\$530	\$583	\$636	\$1,061	\$1,167	\$1,273
54"	24"	EAW15424WS	\$581	\$639	\$697	\$1,162	\$1,278	\$1,394
60"	24"	EAW16024WS	\$637	\$700	\$764	\$1,275	\$1,402	\$1,530
72"	24"	EAW17224WS	\$713	\$784	\$855	\$1,427	\$1,569	\$1,712

Worksurfaces are sized to fit with the Equity system. For stand-alone height adjustable desks see page 126.

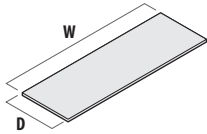

Worksurface Only 30"

For Height Adjustable Supports

W	D	MODEL #	LAMINATE			WOOD VENEER		
			L1	L2	L3	W1	W2	W3
42"	30"	EAW14230WS	\$600	\$660	\$720	\$1,200	\$1,320	\$1,440
48"	30"	EAW14830WS	\$618	\$679	\$741	\$1,238	\$1,361	\$1,485
54"	30"	EAW15430WS	\$694	\$763	\$832	\$1,390	\$1,529	\$1,668
60"	30"	EAW16030WS	\$776	\$853	\$931	\$1,553	\$1,708	\$1,863
72"	30"	EAW17230WS	\$871	\$958	\$1,045	\$1,744	\$1,918	\$2,092

Worksurfaces are sized to fit with the Equity system. For stand-alone height adjustable desks see page 126.

Specify

1. Model #
2. Laminate
3. Edge band
4. Support color
Black or Silver

Grain Direction

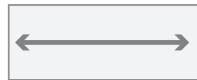

Specification Guidelines

Order an adjustable height work surface to match the panel(s) width the work surface will be attached to. The work surface cannot be configured to cover a partial panel.

When used as a solitary work surface perpendicular panels of 18" minimum width must be specified on both sides for stability.

NOTE: Adjustable work surface meets BIFMA loading requirements for safety. Mechanism is designed to have up to 100 lbs. of load and function smoothly.

Application Notes

Provides 18" of vertical movement.

Wiring & Cabling



Grommet \$29 Scallop \$58

There will be a 1" space around the perimeter of the adjustable height work surface in order to prevent pinch points.

When used in conjunction with a stationary work surface there should be a perpendicular panel at the free end of the adjustable work surface. The free end of the fixed work surface should be supported with a cantilever or pedestal.

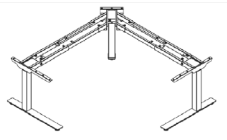

Electric Height Adjustable Base

DESCRIPTION	FOOT DEPTH	MODEL #	BLACK OR SILVER
2 legs	23 3/8"	TBAHL224	\$2,410
3 legs	23 3/8"	TBAHL324	\$3,376

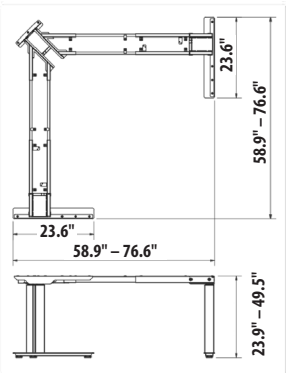
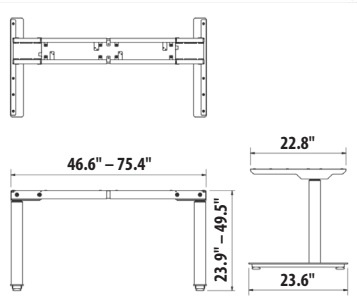

Worksurfaces

Specify

1. Model #
2. Trim color

Application Notes

Electric Height Adjustable Base
 Adjustable height bases can be used with 24" and 30" deep worksurfaces. Worksurfaces must be between 48" – 84" wide.
 Adjustable height bases have a capacity of 264 lbs evenly distributed.
 Comes with four position memory controller.

Anti-collision stops and reverses the travel of the table when the table collides with a fixed object during operation.
 3-stage legs offer a large height adjustment range of 24" – 50".

Worksurfaces

120° Planning

These worksurfaces are designed specifically for Equity 120° applications. The (L/R) suffix at the end of a model number indicates a defined pedestal location. If the worksurface has no defined pedestal location, the (L/R) represents the curved side of the top. All tops and tables are available with 2mm edge band or a cascading edge.

Worksurface: W3

This worksurface, combined with the T3 transition top, works best with the “apartment” layout. This application allows for stations on both sides of the spine, and is ideal for high density layouts. Available in extended versions for placement directly next to another worksurface.

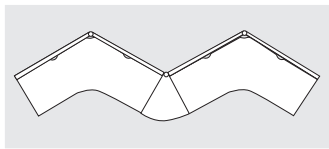

Worksurface: W4

This top works well in the “open house,” “full house,” and “big house” layouts for call center, professional and managerial applications.

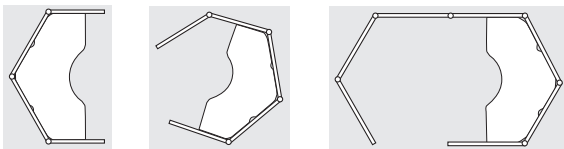

Worksurface: W5 (L/R)

With transition top T5 and this worksurface, teaming is made easy using the “townhouse” or “open house” layout. The shared space allows for call center, professional or technical applications.

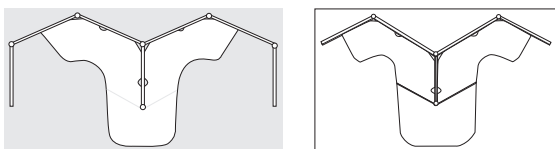

Worksurface: W6 (L/R)

In the “big house,” “full house” or “open house,” this worksurface allows for a pedestal on one side (determined by the L/R).

Applications for this top include a call center with the “open house,” technical applications with the “full house,” and managerial layouts with the “big house.”

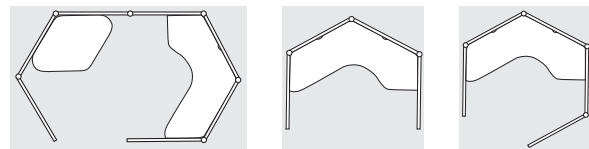

Worksurface: W7 (L/R)

Used in conjunction with a T4 transition top, the W7 worksurface provides a great teaming space when the “townhouse” layout is used. The “open house” layout incorporates the T2 transition top for professional or technical stations with shared space for conferencing. Available in extended versions for placement directly next to another worksurface.

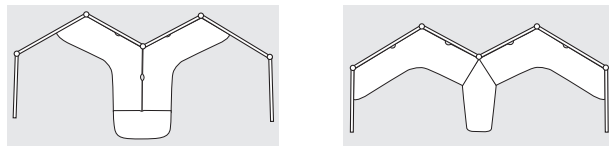

Worksurface: W11 / W1118 (L/R)

This top is a spacious option for a technical station in the “open house” layout. Adding a T2 transition top provides additional teaming space. The W11 surface also fits nicely in a private managerial office or a “full house” professional application.

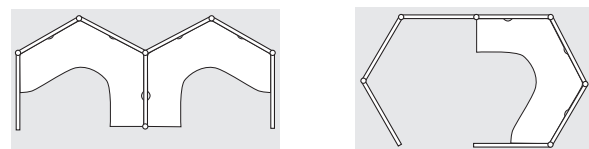

Worksurface: W12 / W1218 (L/R)

This top, with the T5/T518 transition top provides a technical office with shared conferencing space in the “open house” layout. The 18” return allows ample space in the supervisory application of the “full house.”

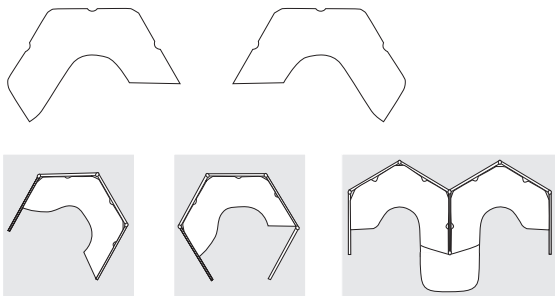

Worksurface: W13 / W1318 (L/R)

This surface provides a teaming space with the T2/T218 transition in the “open house” layout. The W13/W1318 creates generous worksurface space in the “full house” as well as the management layout of the “big house.”

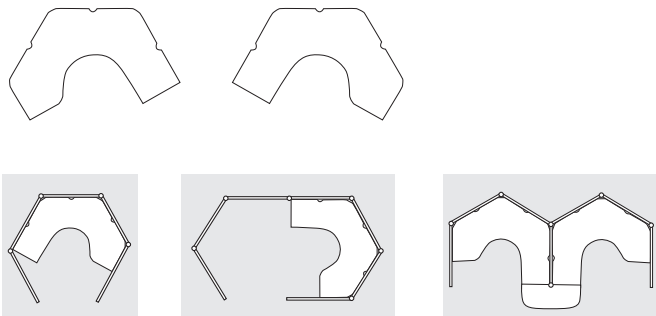

Transition Tops

Transition tops require columns (not included — (page 85)) for support. Flat brackets (not included — (page 84)) are required to attach transition tops to adjacent worksurfaces.



Transition top



Transition top



Transition top



Transition top

Peninsula Tops

Peninsula tops provide additional workspace in a “big house” layout.

Peninsula tops are freestanding and supported by table legs, columns or a combination of both (not included — (page 85)).

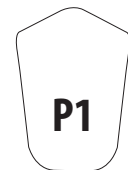

Peninsula top

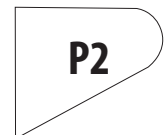

Peninsula top: P2 right hand

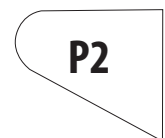

Peninsula top: P2 left hand

Worksurfaces

120°

Worksurfaces

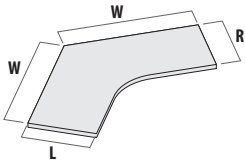

W3

W	L	R	MODEL #	LAMINATE		
				L1	L2	L3
48"	24"	24"	EW1W34824	\$1,289	\$1,417	\$1,546

Woodgrain Direction

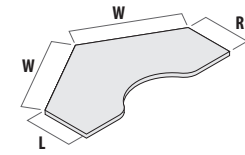

W4

48"	24"	24"	EW1W44824	\$1,301	\$1,431	\$1,561
-----	-----	-----	------------------	---------	---------	---------

Woodgrain Direction

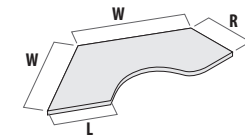

W5

48"	24"	24"	EW1W54824L	\$1,231	\$1,354	\$1,477
48"	24"	24"	EW1W54824R	\$1,231	\$1,354	\$1,477

Woodgrain Direction

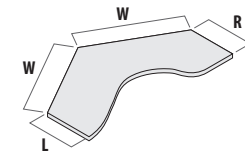
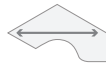

W6

48"	24"	24"	EW1W64824L	\$1,377	\$1,514	\$1,652
48"	24"	24"	EW1W64824R	\$1,377	\$1,514	\$1,652

Woodgrain Direction



Specify

1. Model #
2. Laminate
3. Edge band

Support Information

All supports must be ordered separately. See page 84 – 85.

Worksurface Loading & Support

See page 73.

Application Notes

Refer to the worksurface planning page 90 for worksurface drawings and applications.

W3

W3 top may be extended on either the left or right hand side by adding an "EL" or "ER" to the end of the model number and adding \$21 (list).

W3 top may be extended on both ends by adding an "EB" to the end of the model number and adding \$42 (list).



W7

RETURNS				LAMINATE		
W	L	R	MODEL #	L1	L2	L3
48"	24"	24"	EW1W74824L	\$1,370	\$1,507	\$1,644
48"	24"	24"	EW1W74824R	\$1,370	\$1,507	\$1,644

Woodgrain Direction



W11

RETURNS				LAMINATE		
W	L	R	MODEL #	L1	L2	L3
48"	24"	18"	EW1W11482418	\$1,617	\$1,778	\$1,940
48"	18"	24"	EW1W11481824	\$1,617	\$1,778	\$1,940

Woodgrain Direction



W12

RETURNS				LAMINATE		
W	L	R	MODEL #	L1	L2	L3
48"	24"	18"	EW1W12482418	\$1,718	\$1,889	\$2,061
48"	18"	24"	EW1W12481824	\$1,718	\$1,889	\$2,061
48"	24"	24"	EW1W124824L	\$1,718	\$1,889	\$2,061
48"	24"	24"	EW1W124824R	\$1,718	\$1,889	\$2,061

Woodgrain Direction



W13

RETURNS				LAMINATE		
W	L	R	MODEL #	L1	L2	L3
48"	24"	18"	EW1W13482418	\$1,655	\$1,820	\$1,986
48"	18"	24"	EW1W13481824	\$1,655	\$1,820	\$1,986
48"	24"	24"	EW1W134824L	\$1,655	\$1,820	\$1,986
48"	24"	24"	EW1W134824R	\$1,655	\$1,820	\$1,986

Woodgrain Direction

Specify

1. Model #
2. Laminate
3. Edge band

Support Information

All supports must be ordered separately. See page 84 – 85.

Worksurface Loading & Support
See page 73.

Application Notes

Refer to the worksurface planning page 90 for worksurface drawings and applications.

W7

Straight ends are available extended by adding an "E" to the end of the model number and adding \$21 (list).

Worksurfaces

Transition Tops

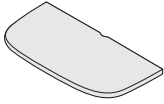

T2

W	RETURN	MODEL #	LAMINATE		
			L1	L2	L3
50"	24"	EW1T224	\$827	\$909	\$992
37 1/2"	18"	EW1T218	\$776	\$853	\$931



T3

26"	24"	EW1T324	\$789	\$867	\$946
-----	-----	----------------	-------	-------	-------

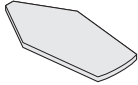

T4

26"	24"	EW1T424	\$814	\$895	\$976
-----	-----	----------------	-------	-------	-------



T5

37 1/2"	18"	EW1T518	\$852	\$937	\$1,022
50"	24"	EW1T524	\$834	\$917	\$1,000



Peninsula Tops

35"	52"	EW1P15235 (L/R)	\$915	\$1,006	\$1,098
36"	38"	EW1P23836(L/R)	\$884	\$972	\$1,060

Worksurfaces

Specify

1. Model #
2. Laminate
3. Edge band

Grain Direction



T2 Transition Top

T2 transition top comes cut to fit against a postless end. If placing against an end with a post, add an "N" to the end of the model number so it is notched for the post.

Support Information

Transition and peninsula tops require a column base for support.

All supports must be ordered separately. See page 84 – 85.

Worksurface Loading & Support
See page 73.

CASCADE EDGE



Cascade edge worksurfaces are wrapped with a thermafoil sheet that is heated and pressed around a substrate. This substrate can be FSC certified upon request. Thermafoil is more susceptible to denting, impact, tearing and marring than conventional high pressure laminate and should be handled with care. Do not drag worksurfaces across any flooring surface. Treat cascade edge worksurfaces like veneer worksurfaces for optimum performance under normal conditions. Cascade edge worksurfaces come with a 10 year warranty that covers defects in workmanship and materials. This warranty does not cover damage occurring during or after installation.

Cascade edge worksurfaces in solid colors utilize a non-PVC construction and are also free of any plasticizers, pthalates and lead content.

AVAILABLE LAMINATES

Solid

114 Folkstone Grey
117 Soft Grey
118 Bright White
119 Pumice

Woodgrain

124 Medium Cherry
125 Natural Maple
126 Natural Cherry
127 Walnut

Cascade Worksurfaces

Straights

Worksurfaces

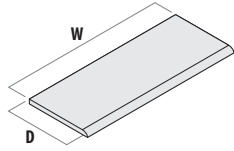

24" Deep

W	D	MODEL #	LAMINATE	
			SOLID	WOODGRAIN
24"	24"	ECE1R2424N	\$280	\$322
30"	24"	ECE1R3024N	\$322	\$369
36"	24"	ECE1R3624N	\$354	\$408
42"	24"	ECE1R4224N	\$408	\$470
48"	24"	ECE1R4824N	\$459	\$528
54"	24"	ECE1R5424N	\$493	\$567
60"	24"	ECE1R6024N	\$535	\$616
66"	24"	ECE1R6624N	\$579	\$663
72"	24"	ECE1R7224N	\$604	\$695
78"	24"	ECE1R7824N	\$650	\$746
84"	24"	ECE1R8424N	\$686	\$789
90"	24"	ECE1R9024N	\$775	\$889
96"	24"	ECE1R9624N	\$846	\$972

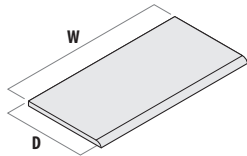

30" Deep

24"	30"	ECE1R2430N	\$356	\$411
30"	30"	ECE1R3030N	\$400	\$459
36"	30"	ECE1R3630N	\$445	\$512
42"	30"	ECE1R4230N	\$483	\$553
48"	30"	ECE1R4830N	\$535	\$616
54"	30"	ECE1R5430N	\$606	\$696
60"	30"	ECE1R6030N	\$667	\$764
66"	30"	ECE1R6630N	\$744	\$855
72"	30"	ECE1R7230N	\$775	\$889
78"	30"	ECE1R7830N	\$826	\$949
84"	30"	ECE1R8430N	\$879	\$1,011
90"	30"	ECE1R9030N	\$945	\$1,086
96"	30"	ECE1R9630N	\$1,011	\$1,160

Sample

12"	12"	ECE1R1212G2	\$172	\$200
-----	-----	-------------	-------	-------

Specify

1. Model #
2. Options
3. Laminate

Extended Ends

E . . . Covers 1 post	\$26
EE . . Covers 2 posts	\$52

Grain Direction

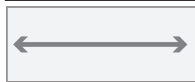

Edge Profile



Wiring & Cabling



Scalloped \$62

Available Laminates

Solid
 114 Folkstone Grey
 117 Soft Grey
 118 Bright White
 119 Pumice

Woodgrain
 124 Medium Cherry
 125 Natural Maple
 126 Natural Cherry
 127 Walnut

Support Information

All supports must be ordered separately. See page 84 – 85.

Worksurface Loading & Support

A center support must be used with a 54" wide or larger worksurface.

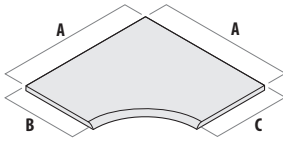

Corner – Curved Front

A	B	C	MODEL #	LAMINATE	
				SOLID	WOODGRAIN
36"	24"	24"	ECE1L3636SSN	\$700	\$806
42"	24"	24"	ECE1L4242SSN	\$846	\$972
42"	24"	30"	ECE1L4242SDN	\$1,005	\$1,152
42"	30"	24"	ECE1L4242DSN	\$1,005	\$1,152
48"	24"	24"	ECE1L4848SSN	\$949	\$1,092
48"	24"	30"	ECE1L4848SDN	\$1,138	\$1,308
48"	30"	24"	ECE1L4848DSN	\$1,138	\$1,308
48"	30"	30"	ECE1L4848DDN	\$1,020	\$1,174

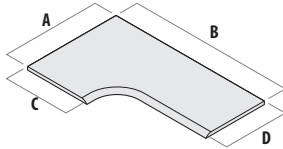

Right Hand

42"	60"	24"	24"	ECE1L4260SS()N	\$1,160	\$1,336
42"	66"	24"	24"	ECE1L4266SS()N	\$1,191	\$1,371
42"	72"	24"	24"	ECE1L4272SS()N	\$1,236	\$1,424
42"	78"	24"	24"	ECE1L4278SS()N	\$1,251	\$1,437
48"	60"	24"	24"	ECE1L4860SS()N	\$1,177	\$1,351
48"	60"	24"	30"	ECE1L4860SD()N	\$1,152	\$1,328
48"	60"	30"	24"	ECE1L4860DS()N	\$1,152	\$1,328
48"	66"	24"	24"	ECE1L4866SS()N	\$1,218	\$1,401
48"	66"	24"	30"	ECE1L4866SD()N	\$1,214	\$1,396
48"	66"	30"	24"	ECE1L4866DS()N	\$1,214	\$1,396
48"	72"	24"	24"	ECE1L4872SS()N	\$1,263	\$1,452
48"	72"	24"	30"	ECE1L4872SD()N	\$1,270	\$1,462
48"	72"	30"	24"	ECE1L4872DS()N	\$1,270	\$1,462
48"	78"	24"	24"	ECE1L4878SS()N	\$1,392	\$1,602
48"	84"	24"	24"	ECE1L4884SS()N	\$1,564	\$1,801

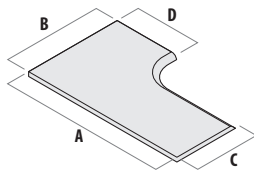

Left Hand

60"	42"	24"	24"	ECE1L6042SS()N	\$1,160	\$1,336
60"	48"	24"	24"	ECE1L6048SS()N	\$1,177	\$1,351
60"	48"	24"	30"	ECE1L6048SD()N	\$1,152	\$1,328
60"	48"	30"	24"	ECE1L6048DS()N	\$1,152	\$1,328
66"	42"	24"	24"	ECE1L6642SS()N	\$1,191	\$1,371
66"	48"	24"	24"	ECE1L6648SS()N	\$1,218	\$1,401
66"	48"	24"	30"	ECE1L6648SD()N	\$1,214	\$1,396
66"	48"	30"	24"	ECE1L6648DS()N	\$1,214	\$1,396
72"	42"	24"	24"	ECE1L7242SS()N	\$1,236	\$1,424
72"	48"	24"	24"	ECE1L7248SS()N	\$1,263	\$1,452
72"	48"	24"	30"	ECE1L7248SD()N	\$1,270	\$1,462
72"	48"	30"	24"	ECE1L7248DS()N	\$1,270	\$1,462
78"	42"	24"	24"	ECE1L7842SS()N	\$1,251	\$1,437
78"	48"	24"	24"	ECE1L7848SS()N	\$1,392	\$1,602
84"	48"	24"	24"	ECE1L8448SS()N	\$1,564	\$1,801

Application Notes

Center-Located Edge Grommet

To specify, replace the "N" suffix from the model number with "G". Add **\$52**.

Equity "L" worksurfaces are handed and may or may not cover a post on either or both sides. Hand is determined from the seated position. Option suffixes for Equity blended corners are as follows:

- X** . . . No posts covered
- L** . . . Left post covered
- R** . . . Right post covered
- B** . . . Both posts covered

Cascade Worksurfaces

Corner Peninsulas

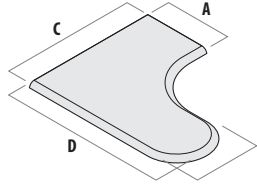
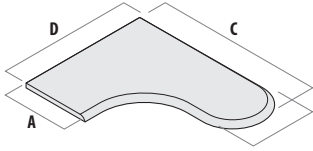

Right Hand

A	C	D	MODEL #	LAMINATE	
				SOLID	WOODGRAIN
24"	66"	48"	ECE1BD6648SR	\$1,134	\$1,303
30"	66"	48"	ECE1BD6648DR	\$1,191	\$1,371
24"	72"	48"	ECE1BD7248SR	\$1,158	\$1,335
30"	72"	48"	ECE1BD7248DR	\$1,235	\$1,421
24"	78"	48"	ECE1BD7848SR	\$1,339	\$1,539
30"	78"	48"	ECE1BD7848DR	\$1,384	\$1,590
24"	84"	48"	ECE1BD8448SR	\$1,375	\$1,581
30"	84"	48"	ECE1BD8448DR	\$1,462	\$1,680

Left Hand

24"	48"	66"	ECE1BD6648SL	\$1,134	\$1,303
30"	48"	66"	ECE1BD6648DL	\$1,191	\$1,371
24"	48"	72"	ECE1BD7248SL	\$1,158	\$1,335
30"	48"	72"	ECE1BD7248DL	\$1,235	\$1,421
24"	48"	78"	ECE1BD7848SL	\$1,339	\$1,539
30"	48"	78"	ECE1BD7848DL	\$1,384	\$1,590
24"	48"	84"	ECE1BD8448SL	\$1,375	\$1,581
30"	48"	84"	ECE1BD8448DL	\$1,462	\$1,680

Specify 1. Model # 2. Options 3. Laminate	Grain Direction 	Wiring & Cabling Scalloped \$62	Available Laminates Solid 114 Folkstone Grey 117 Soft Grey 118 Bright White 119 Pumice Woodgrain 124 Medium Cherry 125 Natural Maple 126 Natural Cherry 127 Walnut	Support Information All supports must be ordered separately. See page 84 – 85. Worksurface Loading & Support See page 73.
Edge Profile 				

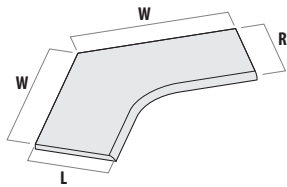
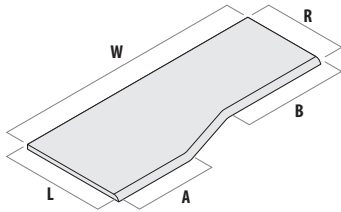
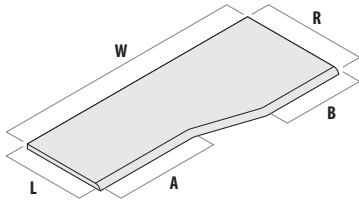

Right Hand

W	L	R	A	B	MODEL #	LAMINATE	
						SOLID	WOODGRAIN
36"	24"	30"	3"	15"	ECE1W362430N	\$752	\$864
42"	24"	30"	9"	15"	ECE1W422430N	\$790	\$911
48"	24"	30"	15"	15"	ECE1W482430N	\$847	\$974
72"	24"	30"	30 1/2"	23 1/2"	ECE1W722430N	\$1,079	\$1,238

Left Hand

W	L	R	A	B	MODEL #	SOLID	WOODGRAIN
36"	30"	24"	15"	1 1/2"	ECE1W363024N	\$752	\$864
42"	30"	24"	15"	7 1/2"	ECE1W423024N	\$790	\$911
48"	30"	24"	15"	15"	ECE1W483024N	\$847	\$974
72"	30"	24"	23 1/2"	30 1/2"	ECE1W723024N	\$1,079	\$1,238

120° Worksurface

W	L	R	A	B	MODEL #	SOLID	WOODGRAIN
48"	48"	24"	24"		ECE1W34824G	\$1,236	\$1,424

Worksurfaces

Specify

1. Model #
2. Options
3. Laminate

Grain Direction



Edge Profile

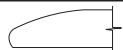

Wiring & Cabling



Scallop \$62

Available Laminates

- Solid**
- 114 Folkstone Grey
 - 117 Soft Grey
 - 118 Bright White
 - 119 Pumice

- Woodgrain**
- 124 Medium Cherry
 - 125 Natural Maple
 - 126 Natural Cherry
 - 127 Walnut

Support Information

All supports must be ordered separately. See page 84 – 85.

Worksurface Loading & Support
See page 73.

Cascade Worksurfaces

Rounds



Half Round

W	D	MODEL #	LAMINATE	
			SOLID	WOODGRAIN
18"	48"	ECE1H4818P	\$604	\$695
48"	18"	ECE1H4818PC	\$604	\$695
48"	18"	ECE1H4818PE	\$604	\$695
60"	24"	ECE1H6024P	\$831	\$960
60"	24"	ECE1H6024PC	\$831	\$960
60"	24"	ECE1H6024PE	\$831	\$960



Corner Round

24"	24"	ECE1CR24L/R	\$322	\$369
-----	-----	-------------	-------	-------



Corner Round w/Notch

24"	24"	ECE1CR24N	\$322	\$369
-----	-----	-----------	-------	-------

Specify

1. Model #
2. Options
3. Laminate

Half Round

- P** Notched for post
- PE** Notched for postless end
- PC** Notched for post with cover

Grain Direction

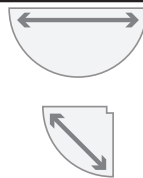

Edge Profile

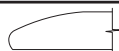

Available Laminates

- Solid**
- 114 Folkstone Grey
 - 117 Soft Grey
 - 118 Bright White
 - 119 Pumice

- Woodgrain**
- 124 Medium Cherry
 - 125 Natural Maple
 - 126 Natural Cherry
 - 127 Walnut

Support Information

All supports must be ordered separately. See page 84 – 85.

Worksurface Loading & Support
See page 73.



Cable Sleeve w/Cover

H	D	MODEL #	BLACK ONLY
1 3/8"	3 1/4"	EW1CS	\$34



Edge Grommet

H	W	D	MODEL #	BLACK ONLY
1 3/8"	2 1/4"	1 3/8"	EW1WSG	\$34

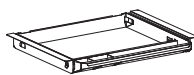

Personal Drawer

DESCRIPTION	MODEL #	BLACK ONLY
Personal Drawer	SPD18	\$422

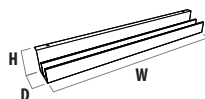

Cable Canal

H	W	D	MODEL #	BLACK ONLY
2"	18"	2"	EWCCNL18	\$359
2"	24"	4"	EWCCNL24	\$416
2"	30"	4"	EWCCNL30	\$497
2"	36"	4"	EWCCNL36	\$532
2"	42"	4"	EWCCNL42	\$693

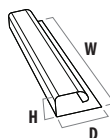

Cable Channel

H	W	D	MODEL #	BLACK ONLY
1 5/8"	32"	2 3/8"	EWCCHL32	\$70

Cable Sleeve with Cover

Used to pass cables through a worksurface. Fits 3" diameter hole, field cut, in worksurface. Smooth plastic prevents abrasion of cords and cables.

Cover snaps into sleeve. Cover has slots that allow passage of one or two cables, yet gives appearance of surface continuity.

Available in black only.

Edge Grommet

Designed to accommodate various styles and quantities of cords/plugs between rear of worksurface and panel for improved cord/plug management. Designed to work with Equity EW1 tops shipped after 2005.

Available in black only.

Worksurface Cable Basket

Attaches to the underside of worksurface for excess cable management. Slides forward from its position adjacent to the panel face to allow passage of plugs. Constructed of steel wire.

Counter Caps Straights

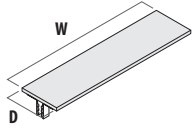

Straight

W (NOMINAL)	W (ACTUAL)	D	MODEL #	LAMINATE			PAINT	
				L1	L2	L3	P2	P3
12"	10 1/2"	15 1/4"	EW(3/N)1215	\$404	\$444	\$484	+ \$30	+ \$60
24"	22 1/2"	15 1/4"	EW(3/N)2415	\$429	\$471	\$514	+ \$30	+ \$60
30"	28 1/2"	15 1/4"	EW(3/N)3015	\$435	\$478	\$522	+ \$30	+ \$60
36"	34 1/2"	15 1/4"	EW(3/N)3615	\$441	\$485	\$529	+ \$30	+ \$60
42"	40 1/2"	15 1/4"	EW(3/N)4215	\$460	\$506	\$552	+ \$30	+ \$60
48"	46 1/2"	15 1/4"	EW(3/N)4815	\$492	\$541	\$590	+ \$30	+ \$60
60"	58 1/2"	15 1/4"	EW(3/N)6015	\$536	\$589	\$643	+ \$30	+ \$60
72"	70 1/2"	15 1/4"	EW(3/N)7215	\$606	\$666	\$727	+ \$30	+ \$60
84"	82 1/2"	15 1/4"	EW(3/N)8415	\$669	\$735	\$802	+ \$30	+ \$60
96"	94 1/2"	15 1/4"	EW(3/N)9615	\$719	\$790	\$862	+ \$30	+ \$60
108"	106 1/2"	15 1/4"	EW(3/N)10815	\$783	\$861	\$939	+ \$30	+ \$60
120"	118 1/2"	15 1/4"	EW(3/N)12015	\$852	\$937	\$1,022	+ \$30	+ \$60

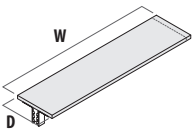

Extended One End

W	W	D	MODEL #	L1	L2	L3	P2	P3
12"	12"	15 1/4"	EW(3/N)1215E	\$416	\$457	\$499	+ \$30	+ \$60
24"	24"	15 1/4"	EW(3/N)2415E	\$441	\$485	\$529	+ \$30	+ \$60
30"	30"	15 1/4"	EW(3/N)3015E	\$448	\$492	\$537	+ \$30	+ \$60
36"	36"	15 1/4"	EW(3/N)3615E	\$454	\$499	\$544	+ \$30	+ \$60
42"	42"	15 1/4"	EW(3/N)4215E	\$473	\$520	\$567	+ \$30	+ \$60
48"	48"	15 1/4"	EW(3/N)4815E	\$505	\$555	\$606	+ \$30	+ \$60
60"	60"	15 1/4"	EW(3/N)6015E	\$549	\$603	\$658	+ \$30	+ \$60
72"	72"	15 1/4"	EW(3/N)7215E	\$618	\$679	\$741	+ \$30	+ \$60
84"	84"	15 1/4"	EW(3/N)8415E	\$682	\$750	\$818	+ \$30	+ \$60
96"	96"	15 1/4"	EW(3/N)9615E	\$733	\$806	\$879	+ \$30	+ \$60
108"	108"	15 1/4"	EW(3/N)10815E	\$795	\$874	\$954	+ \$30	+ \$60

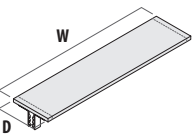

Extended Both End

W	W	D	MODEL #	L1	L2	L3	P2	P3
12"	13 1/2"	15 1/4"	EW(3/N)1215EE	\$429	\$471	\$514	+ \$30	+ \$60
24"	25 1/2"	15 1/4"	EW(3/N)2415EE	\$454	\$499	\$544	+ \$30	+ \$60
30"	31 1/2"	15 1/4"	EW(3/N)3015EE	\$460	\$506	\$552	+ \$30	+ \$60
36"	37 1/2"	15 1/4"	EW(3/N)3615EE	\$467	\$513	\$560	+ \$30	+ \$60
42"	43 1/2"	15 1/4"	EW(3/N)4215EE	\$485	\$533	\$582	+ \$30	+ \$60
48"	49 1/2"	15 1/4"	EW(3/N)4815EE	\$517	\$568	\$620	+ \$30	+ \$60
60"	61 1/2"	15 1/4"	EW(3/N)6015EE	\$561	\$617	\$673	+ \$30	+ \$60
72"	73 1/2"	15 1/4"	EW(3/N)7215EE	\$631	\$694	\$757	+ \$30	+ \$60
84"	85 1/2"	15 1/4"	EW(3/N)8415EE	\$694	\$763	\$832	+ \$30	+ \$60
96"	97 1/2"	15 1/4"	EW(3/N)9615EE	\$745	\$819	\$894	+ \$30	+ \$60
108"	109 1/2"	15 1/4"	EW(3/N)10815EE	\$808	\$888	\$969	+ \$30	+ \$60

Specify

1. Model #
2. Laminate
3. Edge band
4. Cantilever color

Extended Ends

- E** . . . Covers 1 post
EE . . . Covers 2 posts

Application Notes

Counter caps are designed for mounting on top of panels.

Counter caps fit between posts, appropriate to fit between two taller panels and a dual/triple height connectors.

Support Information

Steel cantilevers are supplied.

Top Cap Compatibility

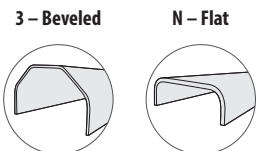

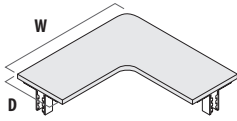

Corner

W	D	MODEL #	LAMINATE			PAINT	
			L1	L2	L3	P2	P3
24"	15 1/4"	EW(3/N)CC2415	\$530	\$583	\$636	+ \$30	+ \$60
30"	15 1/4"	EW(3/N)CC3015	\$549	\$603	\$658	+ \$30	+ \$60
36"	15 1/4"	EW(3/N)CC3615	\$568	\$624	\$681	+ \$30	+ \$60

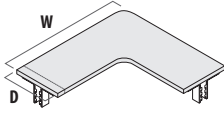

Extended Left

24"	15 1/4"	EW(3/N)CC2415LHE	\$542	\$596	\$650	+ \$30	+ \$60
30"	15 1/4"	EW(3/N)CC3015LHE	\$561	\$617	\$673	+ \$30	+ \$60
36"	15 1/4"	EW(3/N)CC3615LHE	\$581	\$639	\$697	+ \$30	+ \$60

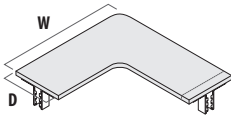

Extended Right

24"	15 1/4"	EW(3/N)CC2415RHE	\$542	\$596	\$650	+ \$30	+ \$60
30"	15 1/4"	EW(3/N)CC3015RHE	\$561	\$617	\$673	+ \$30	+ \$60
36"	15 1/4"	EW(3/N)CC3615RHE	\$581	\$639	\$697	+ \$30	+ \$60

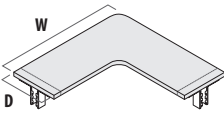

Extended Both

24"	15 1/4"	EW(3/N)CC2415EE	\$556	\$611	\$667	+ \$30	+ \$60
30"	15 1/4"	EW(3/N)CC3015EE	\$574	\$631	\$688	+ \$30	+ \$60
36"	15 1/4"	EW(3/N)CC3615EE	\$593	\$652	\$711	+ \$30	+ \$60

Specify

1. Model #
2. Laminate
3. Edge band
4. Cantilever color

Extended Ends

- E** . . . Covers 1 post
EE . . . Covers 2 posts

Application Notes

Counter caps are designed for mounting on top of panels.

Counter caps fit between posts, appropriate to fit between two taller panels and a dual/triple height connectors.

Support Information

Steel cantilevers are supplied.

Top Cap Compatibility

3 – Beveled

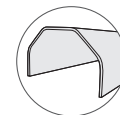

N – Flat



Open Shelves

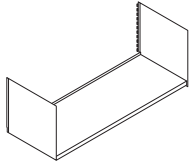

Full Height

W	D	H	MODEL #	PAINT		
				P1	P2	P3
24"	12 3/8"	10 1/4"	ES2OS24	\$279	\$294	\$304
30"	12 3/8"	10 1/4"	ES2OS30	\$307	\$322	\$332
36"	12 3/8"	10 1/4"	ES2OS36	\$307	\$322	\$332
42"	12 3/8"	10 1/4"	ES2OS42	\$320	\$335	\$345
48"	12 3/8"	10 1/4"	ES2OS48	\$335	\$350	\$360
60"	12 3/8"	10 1/4"	ES2OS60	\$359	\$374	\$384
72"	12 3/8"	10 1/4"	ES2OS72	\$389	\$404	\$414

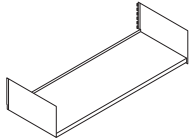

Half Height

24"	12 3/8"	7 1/4"	ES3OS24	\$338	\$353	\$363
30"	12 3/8"	7 1/4"	ES3OS30	\$374	\$389	\$399
36"	12 3/8"	7 1/4"	ES3OS36	\$374	\$389	\$399
42"	12 3/8"	7 1/4"	ES3OS42	\$389	\$404	\$414
48"	12 3/8"	7 1/4"	ES3OS48	\$408	\$423	\$433
60"	12 3/8"	7 1/4"	ES3OS60	\$439	\$454	\$464
72"	12 3/8"	7 1/4"	ES3OS72	\$473	\$488	\$498

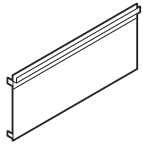

Shelf Back

24"	EC2SB24	\$230	\$240	\$250
30"	EC2SB30	\$253	\$263	\$273
36"	EC2SB36	\$253	\$263	\$273
42"	EC2SB42	\$266	\$276	\$286
48"	EC2SB48	\$277	\$287	\$297
60"	EC2SB60	\$312	\$322	\$332
72"	EC2SB72	\$356	\$366	\$376



Shelf Divider — 4 pack

				BLACK ONLY		
2"	9"	6"	EC2SD	\$160	N/A	N/A

Panel Supported

Specify

1. Model #
2. Paint

Application Notes

Open shelf consists of two steel end panels and one steel shelf.

NOTE: Cannot be converted to an enclosed cabinet.

Shelf Divider

Available in black only.

Shelf Type

	W
ES2OS Open Shelf	36
ES3OS Open Shelf – Half Height	
ES2OS	36

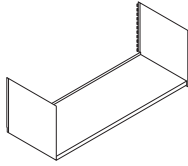

Full Laminate

W	D	H	MODEL #	LAMINATE			WOOD VENEER		
				P1	P2	P3	W1	W2	W3
24"	12 3/8"	10 1/4"	ES2OSL24	\$428	\$471	\$514	\$856	\$942	\$1,028
30"	12 3/8"	10 1/4"	ES2OSL30	\$437	\$481	\$524	\$874	\$962	\$1,048
36"	12 3/8"	10 1/4"	ES2OSL36	\$445	\$490	\$534	\$890	\$980	\$1,068
42"	12 3/8"	10 1/4"	ES2OSL42	\$459	\$505	\$551	\$918	\$1,010	\$1,102
48"	12 3/8"	10 1/4"	ES2OSL48	\$471	\$518	\$565	\$942	\$1,036	\$1,130
60"	12 3/8"	10 1/4"	ES2OSL60	\$667	\$734	\$800	\$1,334	\$1,468	\$1,600
72"	12 3/8"	10 1/4"	ES2OSL72	\$859	\$945	\$1,031	\$1,718	\$1,890	\$2,062

Specify

1. Model #
2. Laminate/Veneer

Application Notes

Can not be converted into an enclosed cabinet.

Shelf Type	W
ES2OSL Open Shelf Full Laminate	36
ES2OSL	36

Overheads

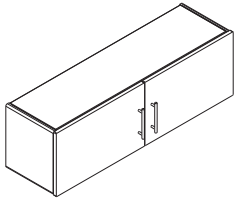

Laminate Front — Side Hinge Door

W	D	H	# DOORS	MODEL #	LAMINATE			PAINT	
					L1	L2	L3	P2	P3
24"	12 1/2"	14 1/4"	2	EC2OL24	\$817	\$899	\$980	+ \$30	+ \$60
30"	12 1/2"	14 1/4"	2	EC2OL30	\$878	\$966	\$1,054	+ \$30	+ \$60
36"	12 1/2"	14 1/4"	2	EC2OL36	\$938	\$1,032	\$1,126	+ \$30	+ \$60
42"	12 1/2"	14 1/4"	2	EC2OL42	\$999	\$1,099	\$1,199	+ \$30	+ \$60
48"	12 1/2"	14 1/4"	2	EC2OL48	\$1,058	\$1,164	\$1,270	+ \$30	+ \$60
60"	12 1/2"	14 1/4"	4	EC2OL60	\$1,482	\$1,630	\$1,778	+ \$30	+ \$60
72"	12 1/2"	14 1/4"	4	EC2OL72	\$1,602	\$1,762	\$1,922	+ \$30	+ \$60

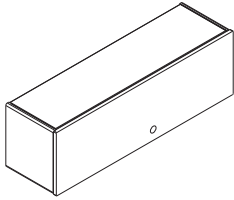

Painted Steel — Flipper Door

W	D	H	# DOORS	MODEL #	PAINT		
					P1	P2	P3
24"	12 1/2"	14 1/4"	1	EC2OP24	\$727	\$752	\$777
30"	12 1/2"	14 1/4"	1	EC2OP30	\$822	\$847	\$872
36"	12 1/2"	14 1/4"	1	EC2OP36	\$822	\$847	\$872
42"	12 1/2"	14 1/4"	1	EC2OP42	\$916	\$941	\$966
48"	12 1/2"	14 1/4"	1	EC2OP48	\$967	\$992	\$1,017
60"	12 1/2"	14 1/4"	1	EC2OP60	\$1,101	\$1,126	\$1,151
72"	12 1/2"	14 1/4"	1	EC2OP72	\$1,212	\$1,237	\$1,262
72"	12 1/2"	14 1/4"	2	EC2OP272	\$1,471	\$1,496	\$1,521

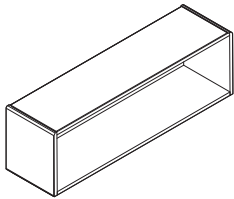

Open

W	D	H	MODEL #			
24"	12 1/2"	14 1/4"	EC2OO24	\$551	\$606	\$661
30"	12 1/2"	14 1/4"	EC2OO30	\$672	\$739	\$806
36"	12 1/2"	14 1/4"	EC2OO36	\$696	\$766	\$835
42"	12 1/2"	14 1/4"	EC2OO42	\$733	\$806	\$880
48"	12 1/2"	14 1/4"	EC2OO48	\$854	\$939	\$1,025
60"	12 1/2"	14 1/4"	EC2OO60	\$974	\$1,071	\$1,169
72"	12 1/2"	14 1/4"	EC2OO72	\$1,095	\$1,205	\$1,314

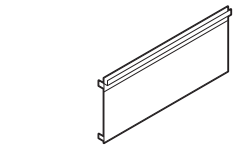

Overhead Back

W	D	H	MODEL #			
24"	5/8"	14"	EC2CB24	\$230	\$240	\$250
30"	5/8"	14"	EC2CB30	\$253	\$263	\$273
36"	5/8"	14"	EC2CB36	\$253	\$263	\$273
42"	5/8"	14"	EC2CB42	\$266	\$276	\$286
48"	5/8"	14"	EC2CB48	\$277	\$287	\$297
60"	5/8"	14"	EC2CB60	\$312	\$322	\$332
72"	5/8"	14"	EC2CB72	\$356	\$366	\$376

Panel Supported

Specify

1. Model #
2. Paint
3. Optional Laminate

Overhead – Side Hinge

Includes matching ABS edge band.

Overhead – Flipper Door

Door uses heavy-duty ball bearing hinges to allow door to flip forward and up and over top of cabinet. Can be opened at an angle. Door rolls on glides for smooth, friction-free operation.

Overhead Type

Model #	Overhead Type	W
EC2OL	Side Hinge	36
EC2OP	Flipper Door	
EC2OO	Open	
ES2OL		36

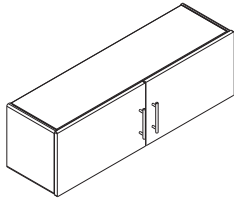

Full Laminate — Side Hinge Door

W	D	H	# DOORS	MODEL #	LAMINATE			WOOD VENEER		
					L1	L2	L3	W1	W2	W3
24"	12 1/2"	14 1/4"	2	EC2OCL24D	\$1,676	\$1,844	\$2,011	\$3,352	\$3,688	\$4,022
30"	12 1/2"	14 1/4"	2	EC2OCL30D	\$1,704	\$1,874	\$2,045	\$3,408	\$3,748	\$4,090
36"	12 1/2"	14 1/4"	2	EC2OCL36D	\$1,734	\$1,907	\$2,081	\$3,468	\$3,814	\$4,162
42"	12 1/2"	14 1/4"	2	EC2OCL42D	\$1,777	\$1,955	\$2,132	\$3,554	\$3,910	\$4,264
48"	12 1/2"	14 1/4"	2	EC2OCL48D	\$1,821	\$2,003	\$2,185	\$3,642	\$4,006	\$4,370
60"	12 1/2"	14 1/4"	4	EC2OCL60D	\$2,473	\$2,720	\$2,968	\$4,946	\$5,440	\$5,936
72"	12 1/2"	14 1/4"	4	EC2OCL72D	\$3,125	\$3,438	\$3,750	\$6,250	\$6,876	\$7,500

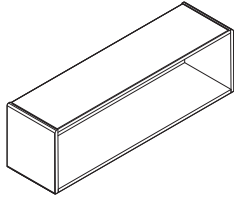

Full Laminate Open

W	D	H	MODEL #	L1	L2	L3	W1	W2	W3
24"	12 1/2"	14 1/4"	EC2OCL24	\$1,429	\$1,572	\$1,715	\$2,858	\$3,144	\$3,430
30"	12 1/2"	14 1/4"	EC2OCL30	\$1,458	\$1,604	\$1,750	\$2,916	\$3,208	\$3,500
36"	12 1/2"	14 1/4"	EC2OCL36	\$1,487	\$1,636	\$1,784	\$2,974	\$3,272	\$3,568
42"	12 1/2"	14 1/4"	EC2OCL42	\$1,531	\$1,684	\$1,837	\$3,062	\$3,368	\$3,674
48"	12 1/2"	14 1/4"	EC2OCL48	\$1,574	\$1,731	\$1,889	\$3,148	\$3,462	\$3,778
60"	12 1/2"	14 1/4"	EC2OCL60	\$2,226	\$2,449	\$2,671	\$4,452	\$4,898	\$5,342
72"	12 1/2"	14 1/4"	EC2OCL72	\$2,863	\$3,149	\$3,436	\$5,726	\$6,298	\$6,872

SHARED STORAGE DIMENSIONS

Equity is measured from the center of the posts on each end of the panel. A standard full laminate overhead is dimensioned to fit in a fully panel wrapped configuration. It is therefore 1-1/2" narrower than the nominal panel dimension. If you would like the full laminate overhead to extend to cover the center of one post you will need to add an "E" to the full laminate overhead item number. This will add 3/4" to the width of the shared storage. If you would like the full laminate overhead to extend to cover the center of both posts then you will need to add "EE", extending the full laminate overhead by 1 1/2" from the standard.

- E** . . . Covers center of 1 post
- EE** . . . Covers center of 2 posts

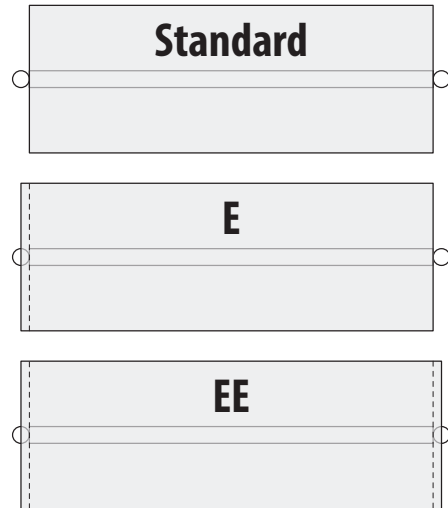

Panel Supported

Specify					Options					
	ES20	Equity Overhead	CL	Full Laminate Overhead	W	D	Door	Extended Ends		
1. Model #					36	14	No Door	E	One End	\$25
2. Laminate/Veneer							D	EE	Both Ends	\$50
Overhead										
Includes matching ABS edge band.	ES20		CL		36	14	D	E		

Shared Storage

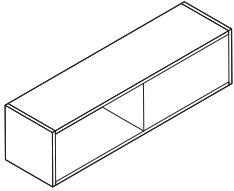

12" H

W	D	H	MODEL #	LAMINATE		
				L1	L2	L3
24"	14"	12"	EC2OY2412	\$1,179	\$1,297	\$1,415
30"	14"	12"	EC2OY3012	\$1,203	\$1,323	\$1,444
36"	14"	12"	EC2OY3612	\$1,227	\$1,350	\$1,472
42"	14"	12"	EC2OY4212	\$1,264	\$1,390	\$1,517
48"	14"	12"	EC2OY4812	\$1,300	\$1,430	\$1,560
60"	14"	12"	EC2OY6012	\$1,807	\$1,988	\$2,168
72"	14"	12"	EC2OY7212	\$2,338	\$2,572	\$2,806
84"	14"	12"	EC2OY8412	\$2,846	\$3,131	\$3,415

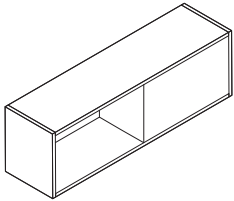

14" H

24"	14"	14 ¼"	EC2OY2414	\$1,192	\$1,311	\$1,430
30"	14"	14 ¼"	EC2OY3014	\$1,216	\$1,338	\$1,459
36"	14"	14 ¼"	EC2OY3614	\$1,240	\$1,364	\$1,488
42"	14"	14 ¼"	EC2OY4214	\$1,276	\$1,404	\$1,531
48"	14"	14 ¼"	EC2OY4814	\$1,313	\$1,444	\$1,576
60"	14"	14 ¼"	EC2OY6014	\$1,855	\$2,041	\$2,226
72"	14"	14 ¼"	EC2OY7214	\$2,387	\$2,626	\$2,864
84"	14"	14 ¼"	EC2OY8414	\$2,906	\$3,197	\$3,487

SHARED STORAGE DIMENSIONS

Equity is measured from the center of the posts on each end of the panel. A standard shared storage is dimensioned to fit in a fully panel wrapped configuration. It is therefore 1-½" narrower than the nominal panel dimension. If you would like the shared storage to extend to cover the center of one post you will need to add an "E" to the shared storage item number. This will add ¾" to the width of the shared storage. If you would like the shared storage to extend to cover the center of both posts then you will need to add "EE", extending the shared storage by 1 ½" from the standard.

- E** . . . Covers center of 1 post
- EE** . . Covers center of 2 posts

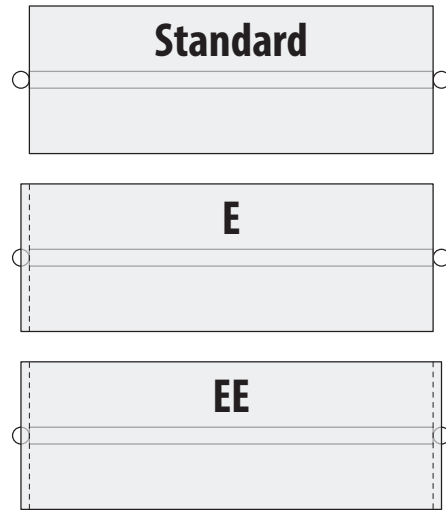

Panel Supported

				W		D		Options		
				36	14	Door		Extended Ends		
ES20	Equity Overhead	Y	Shared Storage	36	14	No Door		E	One End	\$25
						D Door		EE	Both Ends	\$51
						MD Markerboard Door				
ES20				36	14	D		E		

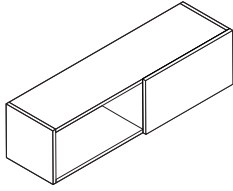

12" H w/Doors — Includes 2 locks

W	D	H	MODEL #	LAMINATE		
				L1	L2	L3
24"	14"	12"	EC2OY2412(D/MD)	\$1,348	\$1,483	\$1,618
30"	14"	12"	EC2OY3012(D/MD)	\$1,385	\$1,524	\$1,662
36"	14"	12"	EC2OY3612(D/MD)	\$1,421	\$1,563	\$1,705
42"	14"	12"	EC2OY4212(D/MD)	\$1,457	\$1,603	\$1,748
48"	14"	12"	EC2OY4812(D/MD)	\$1,493	\$1,642	\$1,792
60"	14"	12"	EC2OY6012(D/MD)	\$2,037	\$2,241	\$2,444
72"	14"	12"	EC2OY7212(D/MD)	\$2,568	\$2,825	\$3,082
84"	14"	12"	EC2OY8412(D/MD)	\$3,027	\$3,330	\$3,632

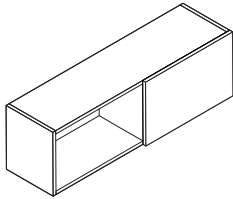

14" H w/Doors — Includes 2 locks

W	D	H	MODEL #	LAMINATE		
				L1	L2	L3
24"	14"	14 ¼"	EC2OY2414(D/MD)	\$1,397	\$1,537	\$1,676
30"	14"	14 ¼"	EC2OY3014(D/MD)	\$1,421	\$1,563	\$1,705
36"	14"	14 ¼"	EC2OY3614(D/MD)	\$1,445	\$1,590	\$1,734
42"	14"	14 ¼"	EC2OY4214(D/MD)	\$1,482	\$1,630	\$1,778
48"	14"	14 ¼"	EC2OY4814(D/MD)	\$1,517	\$1,669	\$1,820
60"	14"	14 ¼"	EC2OY6014(D/MD)	\$2,061	\$2,267	\$2,473
72"	14"	14 ¼"	EC2OY7214(D/MD)	\$2,604	\$2,864	\$3,125
84"	14"	14 ¼"	EC2OY8414(D/MD)	\$3,172	\$3,489	\$3,806

Specify

1. Model #
2. Options
3. Laminate

Shared Storage

Includes matching ABS edge band.

Tackboards

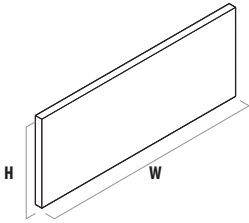

12" H

W	MODEL #	FABRIC							
		A	B	C	D	E	F	G	H
24"	EP1TB2412	\$242	\$267	\$292	\$342	\$442	\$542	\$642	\$742
30"	EP1TB3012	\$301	\$326	\$351	\$401	\$501	\$601	\$701	\$801
36"	EP1TB3612	\$362	\$387	\$412	\$462	\$562	\$662	\$762	\$862
42"	EP1TB4212	\$392	\$417	\$442	\$492	\$592	\$692	\$792	\$892
48"	EP1TB4812	\$422	\$447	\$472	\$522	\$622	\$722	\$822	\$922
60"	EP1TB6012	\$483	\$508	\$533	\$583	\$683	\$783	\$883	\$983

20" H

24"	EP1TB2420	\$362	\$387	\$412	\$462	\$562	\$662	\$762	\$862
30"	EP1TB3020	\$392	\$417	\$442	\$492	\$592	\$692	\$792	\$892
36"	EP1TB3620	\$422	\$447	\$472	\$522	\$622	\$722	\$822	\$922
42"	EP1TB4220	\$453	\$478	\$503	\$553	\$653	\$753	\$853	\$953
48"	EP1TB4820	\$483	\$508	\$533	\$583	\$683	\$783	\$883	\$983
60"	EP1TB6020	\$543	\$568	\$593	\$643	\$743	\$843	\$943	\$1,043

25" H

24"	EP1TB2425	\$422	\$447	\$472	\$522	\$622	\$722	\$822	\$922
30"	EP1TB3025	\$453	\$478	\$503	\$553	\$653	\$753	\$853	\$953
36"	EP1TB3625	\$483	\$508	\$533	\$583	\$683	\$783	\$883	\$983
42"	EP1TB4225	\$512	\$537	\$562	\$612	\$712	\$812	\$912	\$1,012
48"	EP1TB4825	\$543	\$568	\$593	\$643	\$743	\$843	\$943	\$1,043
60"	EP1TB6025	\$604	\$629	\$654	\$704	\$804	\$904	\$1,004	\$1,104

36" H

24"	EP1TB2436	\$483	\$508	\$533	\$583	\$683	\$783	\$883	\$983
30"	EP1TB3036	\$543	\$568	\$593	\$643	\$743	\$843	\$943	\$1,043
36"	EP1TB3636	\$573	\$598	\$623	\$673	\$773	\$873	\$973	\$1,073
42"	EP1TB4236	\$604	\$629	\$654	\$704	\$804	\$904	\$1,004	\$1,104
48"	EP1TB4836	\$633	\$658	\$683	\$733	\$833	\$933	\$1,033	\$1,133
60"	EP1TB6036	\$694	\$719	\$744	\$794	\$894	\$994	\$1,094	\$1,194

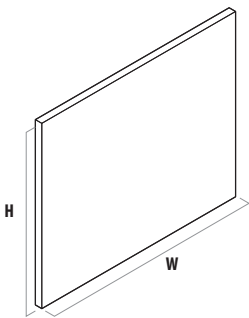

Panel Supported

Specify

1. Model #
2. Fabric

Application Notes

Specify in areas where heavy tacking application is required.

Solid core construction will easily accept T-pins, push pins and thumbtacks.

Clips attach unit to slotted standards.

		W	H	Options	
EW1	Tackboard	48	20	Extended Ends	
				E	One End \$24
				EE	Both Ends \$48
EP1TB		36	20	E	



Wall Mounted Channel

W	D	H	H (Actual)	MODEL #	PAINT		
					P1	P2	P3
2 7/8"	3/4"	29"	23"	EP3WMC29	\$134	\$139	\$146
2 7/8"	3/4"	41"	35"	EP3WMC41	\$134	\$139	\$146
2 7/8"	3/4"	49"	43"	EP3WMC49	\$138	\$145	\$153
2 7/8"	3/4"	54"	49"	EP3WMC54	\$140	\$147	\$155
2 7/8"	3/4"	61"	55"	EP3WMC61	\$156	\$162	\$173
2 7/8"	3/4"	64"	58"	EP3WMC64	\$160	\$173	\$178
2 7/8"	3/4"	66"	60"	EP3WMC66	\$160	\$173	\$178
2 7/8"	3/4"	81"	75"	EP3WMC81	\$195	\$202	\$213
2 7/8"	3/4"	120"	120"	EP3WMC120	\$300	\$315	\$331

Specify – Wall Mounted Channel

1. Model #
2. Paint

Wall Mounted Channel Application Notes

Allows hanging of all components and accessories on reinforced building walls.

Painted extruded aluminum with a plastic insert which snaps in place, covering mounting screws.

NOTE: Neutral Posture, Inc. assumes no responsibility for wall construction or performance of fasteners used.

Assembly – Wall Mounted Channel

- Included**
- Extruded aluminum channel
 - Insert which snaps into place

LIGHTING

Just as the design of a work environment is important, a company's investment in workplace lighting is equally such. Light empowers a person's work, influences their mood and helps them focus. Workers need well-lit spaces to be productive

and feel their best. Developing a work environment that supports worker well being and performance through the use of lighting will reduce employee stress, absenteeism and accidents while increasing work performance.

LIGHTING

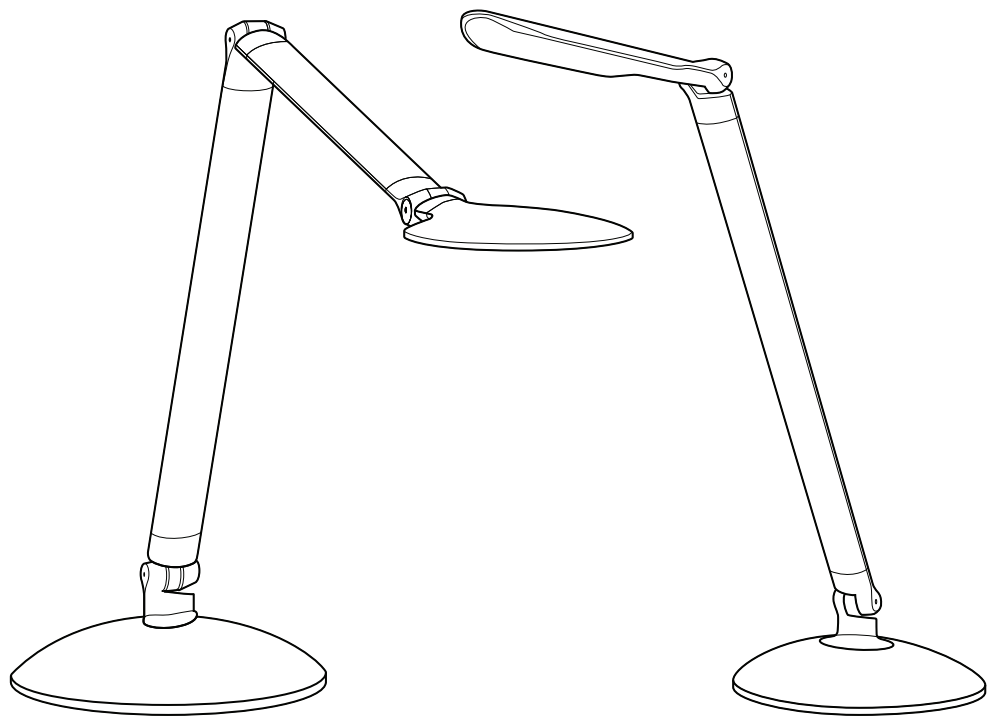

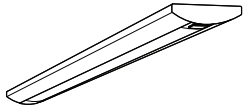

REED Premier — Stand alone w/18-watt power supply

DESCRIPTION	H	W	D	WATTAGE	MODEL #	LIST
Suggested shelf size 24" – 36"	½"	16 ½"	2"	8.0	LRPSO-17-SA	\$479
Suggested shelf size 30" – 42"	½"	23 ¼"	2"	12.4	LRPSO-24-SA	\$624

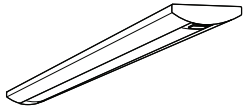

REED Premier — Stand alone or starter w/60-watt power supply

Suggested shelf size 24" – 36"	½"	16 ½"	2"	8.0	LRPSO-17-ST	\$575
Suggested shelf size 30" – 42"	½"	23 ¼"	2"	12.4	LRPSO-24-ST	\$720
Suggested shelf size 42" – 48"	½"	30"	2"	16.4	LRPSO-31-ST	\$757
Suggested shelf size 54" – 60"	½"	43 ¾"	2"	24.2	LRPSO-44-ST	\$938
Suggested shelf size >=72"	½"	57 ½"	2"	31.2	LRPSO-58-ST	\$1,155

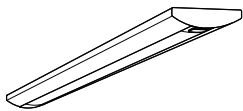

REED Premier — Extension

Suggested shelf size 24" – 36"	½"	16 ½"	2"	8.0	LRPSO-17-EX	\$431
Suggested shelf size 30" – 42"	½"	23 ¼"	2"	12.4	LRPSO-24-EX	\$600
Suggested shelf size 42" – 48"	½"	30"	2"	16.4	LRPSO-31-EX	\$636
Suggested shelf size 54" – 60"	½"	43 ¾"	2"	24.2	LRPSO-44-EX	\$841

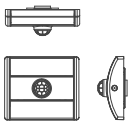

REED Premier — Accessories

Occupancy sensor kit	¾"	2"	2"		LRP-OS	\$322
----------------------	----	----	----	--	---------------	-------

Specify

1. Model #

REED Premier

Properly diffused light provides a softly blended light pattern that reduces eye strain.

A single-touch on/off and touch and hold continuous dimming pad with last state memory.

The automatic turn off feature comes standard and will turn the fixture off after 10 hours of continuous use (±15 mins).

Specify Notes

60-watt power supply is required when interlinking.

Total interlinked system wattage cannot exceed 54 watts. See the interlinking combination chart for reference.

Extension fixtures come standard with 8" and 30" interlinking cords.

One occupancy sensor needed per string of interlinked fixtures.

Interlinking Combination Chart

	17"	24"	31"	44"	58"		17"	24"	31"	44"	58"
6	0	0	0	0	0	1	3	0	0	0	0
5	1	0	0	0	0	1	2	1	0	0	0
5	0	0	0	0	0	1	1	2	0	0	0
4	1	0	0	0	0	1	0	2	0	0	0
4	0	1	0	0	0	1	0	1	1	0	0
4	0	0	0	0	0	1	0	0	1	0	0
3	2	0	0	0	0	1	0	0	0	0	1
3	1	1	0	0	0	0	4	0	0	0	0
3	0	1	0	0	0	0	3	1	0	0	0
3	0	0	1	0	0	0	2	1	0	0	0
3	0	0	0	0	0	0	1	1	1	0	0
2	3	0	0	0	0	0	1	0	0	0	1
2	2	0	0	0	0	0	0	3	0	0	0
2	0	2	0	0	0	0	0	2	0	0	0
2	0	1	0	0	0	0	0	0	1	1	0
2	0	0	1	0	0	0	0	0	1	0	1
2	0	0	0	0	1	0	0	0	0	2	0
2	0	0	0	0	0	0	0	0	0	0	0

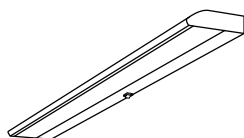

Tazetta — Black

DESCRIPTION	H	W	D	MODEL #	LIST
Use with 24" wide overhead	1.3"	13"	4.38"	LTAZ13BLK	\$365
Use with 30" – 36" wide overhead	1.3"	23.3"	4.38"	LTAZ24BLK	\$411
Use with 42" – 48" wide overhead	1.3"	35.1"	4.38"	LTAZ36BLK	\$462
Use with 54" – 60" wide overhead	1.3"	46.9"	4.38"	LTAZ48BLK	\$495
Use with 70" or wider overhead	1.3"	58.7"	4.38"	LTAZ60BLK	\$621

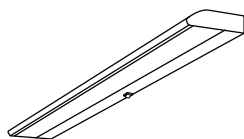

Tazetta — White

DESCRIPTION	H	W	D	MODEL #	LIST
Use with 24" wide overhead	1.3"	13"	4.38"	LTAZ13WHT	\$376
Use with 30" – 36" wide overhead	1.3"	23.3"	4.38"	LTAZ24WHT	\$423
Use with 42" – 48" wide overhead	1.3"	35.1"	4.38"	LTAZ36WHT	\$476
Use with 54" – 60" wide overhead	1.3"	46.9"	4.38"	LTAZ48WHT	\$509
Use with 70" or wider overhead	1.3"	58.7"	4.38"	LTAZ60WHT	\$639

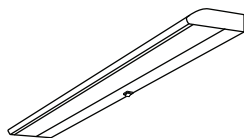

Tazetta — Gray

DESCRIPTION	H	W	D	MODEL #	LIST
Use with 24" wide overhead	1.3"	13"	4.38"	LTAZ13GRY	\$376
Use with 30" – 36" wide overhead	1.3"	23.3"	4.38"	LTAZ24GRY	\$423
Use with 42" – 48" wide overhead	1.3"	35.1"	4.38"	LTAZ36GRY	\$476
Use with 54" – 60" wide overhead	1.3"	46.9"	4.38"	LTAZ48GRY	\$509
Use with 70" or wider overhead	1.3"	58.7"	4.38"	LTAZ60GRY	\$639

Specify

1. Model #

Application Notes

Lamp
T5 fluorescent

Color Temperature
3500K

Certifications
ETL listed: compliant to
UL 153 & CSA C22.2 No.
250.4; UL 1598; TAA

Power Consumption

13"	24"	36"	48"	60"
8W	14W	21W	28W	35W

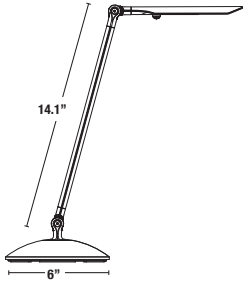

Voyage — Single arm

DESCRIPTION	MODEL #	LIST
Freestanding	LVOY-S-FS-(B,W,S)	\$962
Freestanding w/occupancy sensor	LVOY-S-FS-(B,W,S)-OS	\$1,179
Freestanding USB	LVOY-S-FSUSB-(B,W,S)	\$1,034
Freestanding USB w/occupancy sensor	LVOY-S-FSUSB-(B,W,S)-OS	\$1,276
Surface mount	LVOY-S-SM-(B,W,S)	\$962
Surface mount w/occupancy sensor	LVOY-S-SM-(B,W,S)-OS	\$1,179
Clamp mount	LVOY-S-CM-(B,W,S)	\$962
Clamp mount w/occupancy sensor	LVOY-S-CM-(B,W,S)-OS	\$1,179

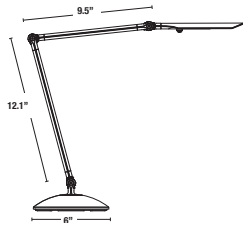

Voyage — Double arm

DESCRIPTION	MODEL #	LIST
Freestanding	LVOY-D-FS-(B,W,S)	\$1,058
Freestanding w/occupancy sensor	LVOY-D-FS-(B,W,S)-OS	\$1,276
Freestanding USB	LVOY-D-FSUSB-(B,W,S)	\$1,179
Freestanding USB w/occupancy sensor	LVOY-D-FSUSB-(B,W,S)-OS	\$1,361
Surface mount	LVOY-D-SM-(B,W,S)	\$1,058
Surface mount w/occupancy sensor	LVOY-D-SM-(B,W,S)-OS	\$1,276
Clamp mount	LVOY-D-CM-(B,W,S)	\$1,179
Clamp mount w/occupancy sensor	LVOY-D-CM-(B,W,S)-OS	\$1,276

Specify

1. Model #

Voyage

Properly diffused light provides a softly blended light pattern that reduces eye strain.

A single-touch on/off and touch and hold continuous dimming pad with last state memory.

The automatic turn off feature comes standard and will turn the fixture off after 10 hours of continuous use.

The optional occupancy sensor will turn the fixture off after 30 minutes of inactivity and back on as the user re-enters the workspace. If occupant is present, the light will remain on.

Color Options

B – Black
W – White
S – Silver

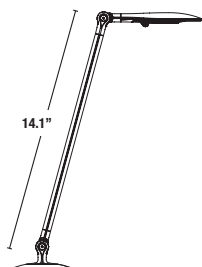

Revo — Single arm

DESCRIPTION	MODEL #	LIST
Freestanding	LREV-S-FS-(B,W,S)	\$962
Freestanding w/occupancy sensor	LREV-S-FS-(B,W,S)-OS	\$1,179
Freestanding USB	LREV-S-FSUSB-(B,W,S)	\$1,058
Freestanding USB w/occupancy sensor	LREV-S-FSUSB-(B,W,S)-OS	\$1,216
Surface mount	LREV-S-SM-(B,W,S)	\$962
Surface mount w/occupancy sensor	LREV-S-SM-(B,W,S)-OS	\$1,179
Clamp mount	LREV-S-CM-(B,W,S)	\$962
Clamp mount w/occupancy sensor	LREV-S-CM-(B,W,S)-OS	\$1,179

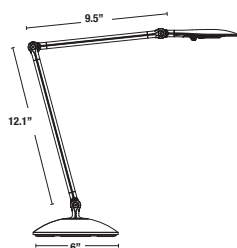

Revo — Double Arm

DESCRIPTION	MODEL #	LIST
Freestanding	LREV-D-FS-(B,W,S)	\$1,058
Freestanding w/occupancy sensor	LREV-D-FS-(B,W,S)-OS	\$1,276
Freestanding USB	LREV-D-FSUSB-(B,W,S)	\$1,179
Freestanding USB w/occupancy sensor	LREV-D-FSUSB-(B,W,S)-OS	\$1,361
Surface mount	LREV-D-SM-(B,W,S)	\$1,058
Surface mount w/occupancy sensor	LREV-D-SM-(B,W,S)-OS	\$1,179
Clamp mount	LREV-D-CM-(B,W,S)	\$1,058
Clamp mount w/occupancy sensor	LREV-D-CM-(B,W,S)-OS	\$1,179

Specify

1. Model #

Application Notes

Properly diffused light source under the round head provides a softly blended light pattern that reduces eye strain.

Single-touch on/off and touch and hold continuous dimming pad with last state memory.

The automatic turn off feature comes standard and will turn the fixture off after 10 hours of continuous use.

The optional occupancy sensor will turn the fixture off after 30 minutes of inactivity and back on as the user re-enters the workspace. If occupant is present, the light will remain on.

Color Options

B – Black
W – White
S – Silver

Tables

General Info

Step 1 – Model

		Shape	D	W
TB	Table	R Round S Square RCT Rectangle OT Oval	34	69
TB		RCT	34	69

Step 2 – Surface Finish

Laminate	
PW-STK	Studio Teak
PW-STK	

Step 3 – Edge Finish

Edge Band	
EB-STK	Studio Teak
EB-STK	

Step 4 – Trim Finish

Paints	
301	Champagne
301	

FEATURES

BASE TYPES

- X Base
- Y Base w/ or w/o adjustable bar support
- Tapered Leg

BASE OPTIONS

- Bar height
- Flip top
- Casters

NOTE: Not all options are available on all bases.

WORKSURFACE TYPES

- Round
- Square
- Rectangular
- Oval

LEVELERS

Adjustable height levelers are included at no additional cost on all models.

Shank Length

X & Y bases — ⅜-16 x ¾"
Tapered legs — ⅜-16 x 1 ¾"

Leveler extensions can be ordered separately. Please contact Customer Service for information on ordering leveler extensions. Casters can be ordered in place of levelers for an upcharge on most standard height tables.

SAFETY

For safety and stability purposes, the caster and flip top options cannot be added to bar height tables or the following table models: TBR60, TBS48, TBS60, TBOT54120, TBOT60144.

CUSTOM TABLES

Custom size tables and custom height bases are available upon request, pending Engineering approval. Customization charges may apply. Contact Customer Service for additional information and pricing.

CONSTRUCTION

X BASE

X bases are made from cast aluminum with 2 ¼" tubing OD x 13 gauge.

Y BASE

Y base is made from cast aluminum with 2 ¼" steel tube.

X BASE MOUNTING PLATES

X base mounting plates are made of steel 4 gauge x 12" x 12" or 8" x 8".

Y BASE MOUNTING PLATES

Y base mounting plates are made from 0.187" x 6" x 8" fabricated steel.

WORKSURFACES

All worksurfaces are made with a core, high pressure laminate and edge band. All non-woodgrain edge bands are made of ABS material. All woodgrain edge bands are made of PVC material. The overall thickness is 1 ⅛".

WORKSURFACE HEIGHTS

Standard	27 ¾"
Bar Height	40 ¾"

SURFACE MATERIALS

WORKSURFACE

- Laminate
- Edge band

X BASES

Paint

Y BASE

Paint

TAPERED LEGS

Paint

HEIGHT ADJUSTABLE BASE

Black or silver

TABLES

Free Standing



Tables

Occasional – Round



Round — w/X base

DESCRIPTION	H	W	D	MODEL #	LAMINATE			PAINT	
					L1	L2	L3	P2	P3
X base	29"	23 3/4"	23 3/4"	TBR24X	\$1,357	\$1,493	\$1,628	+ \$126	+ \$253
X base	29"	29 3/4"	29 3/4"	TBR30X	\$1,421	\$1,563	\$1,705	+ \$126	+ \$253
X base	29"	35 3/4"	35 3/4"	TBR36X	\$1,453	\$1,598	\$1,744	+ \$126	+ \$253
X base	29"	41 3/4"	41 3/4"	TBR42X	\$1,547	\$1,702	\$1,856	+ \$126	+ \$253
X base	29"	47 3/4"	47 3/4"	TBR48X	\$1,908	\$2,099	\$2,290	+ \$126	+ \$253
X base	29"	53 3/4"	53 3/4"	TBR54X	\$3,096	\$3,406	\$3,715	+ \$126	+ \$253



Round — w/Tapered legs

DESCRIPTION	H	W	D	MODEL #	L1	L2	L3	P2	P3
4 Tapered legs	29"	29 3/4"	29 3/4"	TBR30T	\$2,022	\$2,224	\$2,426	+ \$126	+ \$253
4 Tapered legs	29"	35 3/4"	35 3/4"	TBR36T	\$2,053	\$2,258	\$2,464	+ \$126	+ \$253
4 Tapered legs	29"	41 3/4"	41 3/4"	TBR42T	\$2,085	\$2,294	\$2,502	+ \$126	+ \$253
4 Tapered legs	29"	47 3/4"	47 3/4"	TBR48T	\$2,117	\$2,329	\$2,540	+ \$126	+ \$253

Free Standing



Round — w/Disc base

DESCRIPTION	H	W	D	MODEL #	L1	L2	L3	P2	P3
Disc base	29"	29 3/4"	29 3/4"	TBR30D	\$2,688	\$2,957	\$3,226	+ \$126	+ \$253
Disc base	29"	35 3/4"	35 3/4"	TBR36D	\$2,815	\$3,097	\$3,378	+ \$126	+ \$253



Round — w/TT base

DESCRIPTION	H	W	D	MODEL #	L1	L2	L3	P2	P3
TT base	29"	59 3/4"	59 3/4"	TBR60TT	\$3,222	\$3,544	\$3,866	+ \$126	+ \$253
TT base	29"	65 3/4"	65 3/4"	TBR66TT	\$3,286	\$3,615	\$3,943	+ \$126	+ \$253
TT base	29"	71 3/4"	71 3/4"	TBR72TT	\$3,349	\$3,684	\$4,019	+ \$126	+ \$253

Options for Round Tables

DESCRIPTION	OPTION CODE	X BASE	TAPERED LEGS	DISC BASE	TT BASE	UPCHARGE
Bar height	BH	•		•		+ \$126
Casters (set of 4)	C	•	•		•	+ \$126
Flip top	FT	•		•		+ \$253

Specify

1. Model #
2. Options
3. Laminate
4. Edge band
5. Base paint

Grain Direction

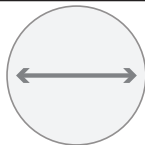

Shape		D	Base	
TB	Table	30	X	X base
	R Round		T	Tapered legs
	S Square		D	Disc base
	RCT Rectangle		TT	TT base
	OT Oval			
TB	R	30	X	

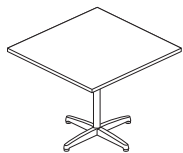

Square — w/X base

DESCRIPTION	H	W	D	MODEL #	LAMINATE			PAINT	
					L1	L2	L3	P2	P3
X base	29"	23 3/4"	23 3/4"	TBS24X	\$1,358	\$1,494	\$1,630	+ \$126	+ \$253
X base	29"	29 3/4"	29 3/4"	TBS30X	\$1,421	\$1,563	\$1,705	+ \$126	+ \$253
X base	29"	35 3/4"	35 3/4"	TBS36X	\$1,517	\$1,669	\$1,820	+ \$126	+ \$253
X base	29"	41 3/4"	41 3/4"	TBS42X	\$1,579	\$1,737	\$1,895	+ \$126	+ \$253
X base	29"	53 3/4"	53 3/4"	TBS54X	\$3,096	\$3,406	\$3,715	+ \$126	+ \$253

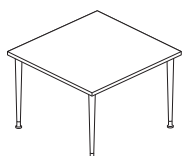

Square — w/Tapered legs

DESCRIPTION	H	W	D	MODEL #	LAMINATE			PAINT	
					L1	L2	L3	P2	P3
4 Tapered Legs	29"	29 3/4"	29 3/4"	TBS30T	\$2,022	\$2,224	\$2,426	+ \$126	+ \$253
4 Tapered Legs	29"	35 3/4"	35 3/4"	TBS36T	\$2,053	\$2,258	\$2,464	+ \$126	+ \$253
4 Tapered Legs	29"	41 3/4"	41 3/4"	TBS42T	\$2,066	\$2,273	\$2,479	+ \$126	+ \$253
4 Tapered Legs	29"	47 3/4"	47 3/4"	TBS48T	\$2,085	\$2,294	\$2,502	+ \$126	+ \$253

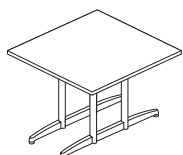

Square — w/TT base

DESCRIPTION	H	W	D	MODEL #	LAMINATE			PAINT	
					L1	L2	L3	P2	P3
TT base	29"	59 3/4"	59 3/4"	TBS60TT	\$3,222	\$3,544	\$3,866	+ \$126	+ \$253
TT base	29"	65 3/4"	65 3/4"	TBS66TT	\$3,286	\$3,615	\$3,943	+ \$126	+ \$253
TT base	29"	71 3/4"	71 3/4"	TBS72TT	\$3,349	\$3,684	\$4,019	+ \$126	+ \$253

Options for Square Tables

DESCRIPTION	OPTION CODE	X BASE	TAPERED LEGS	TT BASE	UPCHARGE
Bar height	BH	•			+ \$126
Casters (set of 4)	C	•	•	•	+ \$126
Flip top	FT	•			+ \$253

Free Standing

Specify

1. Model #
2. Options
3. Laminate
4. Edge band
5. Base paint

Grain Direction



		Shape	D	Base
TB	Table	R Round S Square RCT Rectangle OT Oval	30	X X base T Tapered legs TT TT Base
TB		S	30	X

Tables

Conference – Oval



Oval — w/Y base

DESCRIPTION	H	W	D	MODEL #	LAMINATE			PAINT	
					L1	L2	L3	P2	P3
w/stretcher	29"	71 3/4"	35 3/4"	TBOT3672Y	\$4,031	\$4,434	\$4,837	+ \$253	+ \$379
w/stretcher	29"	95 3/4"	47"	TBOT4896Y	\$6,603	\$7,263	\$7,924	+ \$253	+ \$379
w/stretcher	29"	119 3/4"	47"	TBOT48120Y	\$8,082	\$8,890	\$9,698	+ \$253	+ \$379

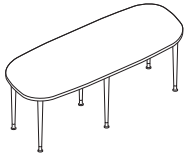

Oval — w/Tapered legs

DESCRIPTION	H	W	D	MODEL #	L1	L2	L3	P2	P3
6 Tapered legs	29"	71 3/4"	35 3/4"	TBOT3672T	\$4,044	\$4,448	\$4,853	+ \$315	+ \$442
6 Tapered legs	29"	95 3/4"	47"	TBOT4896T	\$4,423	\$4,865	\$5,308	+ \$315	+ \$442
6 Tapered legs*	29"	119 3/4"	47"	TBOT48120T	\$4,865	\$5,352	\$5,838	+ \$315	+ \$442
6 Tapered legs*	29"	119 3/4"	53 3/4"	TBOT54120T	\$8,721	\$9,593	\$10,465	+ \$315	+ \$442
6 Tapered legs*	29"	143 3/4"	59 3/4"	TBOT60144T	\$9,479	\$10,427	\$11,375	+ \$315	+ \$442

* Includes a support rail

Options for Oval Tables

DESCRIPTION	OPTION CODE	Y BASE	TAPERED LEGS	UPCHARGE
Bar height	BH	•		+ \$379
Casters (set of 4)	C	•	•	+ \$126
Flip top	FT	•		+ \$379

Free Standing

Specify

1. Model #
2. Options
3. Laminate
4. Edge band
5. Base paint

Grain Direction

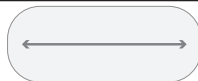

TB	Table	Shape	D	W	Base
		R Round	34	69	Y Y base
		S Square			T Tapered legs
		RCT Rectangle			
		OT Oval			
TB		OT	34	69	Y



Rectangle — w/Y base

DESCRIPTION	H	W	D	MODEL #	LAMINATE			PAINT	
					L1	L2	L3	P2	P3
w/o stretcher	29"	47 3/4"	29 3/4"	TBRCT3048Y	\$1,788	\$1,967	\$2,146	+ \$253	+ \$379
w/stretcher	29"	53 3/4"	23 3/4"	TBRCT2454Y	\$1,738	\$1,912	\$2,086	+ \$253	+ \$379
w/stretcher	29"	59 3/4"	23 3/4"	TBRCT2460Y	\$2,117	\$2,329	\$2,540	+ \$253	+ \$379
w/stretcher	29"	58 1/2"	35 1/2"	TBRCT3660Y	\$2,572	\$2,829	\$3,086	+ \$253	+ \$379
w/stretcher	29"	59 3/4"	29 3/4"	TBRCT3060Y	\$2,179	\$2,397	\$2,615	+ \$253	+ \$379
w/stretcher	29"	65 3/4"	23 3/4"	TBRCT2466Y	\$2,401	\$2,641	\$2,881	+ \$253	+ \$379
w/stretcher*	29"	69 1/4"	34"	TBRCT3469Y	\$3,873	\$4,260	\$4,648	+ \$253	+ \$379
w/stretcher*	29"	71 3/4"	23 3/4"	TBRCT2472Y	\$2,464	\$2,710	\$2,957	+ \$253	+ \$379
w/stretcher*	29"	71 3/4"	29 3/4"	TBRCT3072Y	\$2,572	\$2,829	\$3,086	+ \$253	+ \$379
w/stretcher*	29"	71 3/4"	35 3/4"	TBRCT3672Y	\$3,052	\$3,357	\$3,662	+ \$253	+ \$379
w/stretcher*	29"	79 1/4"	34"	TBRCT3479Y	\$3,873	\$4,260	\$4,648	+ \$253	+ \$379
w/stretcher*	29"	83 3/4"	41 3/4"	TBRCT4284Y	\$4,139	\$4,553	\$4,967	+ \$253	+ \$379
w/stretcher*	29"	95 3/4"	47 3/4"	TBRCT4896Y	\$5,263	\$5,789	\$6,316	+ \$253	+ \$379

* Includes a support rail

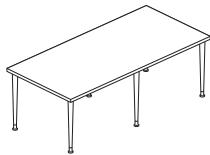

Rectangle — w/Tapered legs

DESCRIPTION	H	W	D	MODEL #	L1	L2	L3	P2	P3
4 Tapered legs	29"	47 3/4"	29 3/4"	TBRCT3048T	\$2,401	\$2,641	\$2,881	+ \$315	+ \$442
4 Tapered legs	29"	58 1/2"	35 1/2"	TBRCT3660T	\$2,780	\$3,058	\$3,336	+ \$315	+ \$442
4 Tapered legs	29"	59 3/4"	29 3/4"	TBRCT3060T	\$2,654	\$2,919	\$3,185	+ \$315	+ \$442
6 Tapered legs	29"	69 1/4"	34"	TBRCT3469T	\$2,907	\$3,198	\$3,488	+ \$315	+ \$442
6 Tapered legs	29"	71 3/4"	29 3/4"	TBRCT3072T	\$2,654	\$2,919	\$3,185	+ \$315	+ \$442
6 Tapered legs	29"	71 3/4"	35 3/4"	TBRCT3672T	\$2,907	\$3,198	\$3,488	+ \$315	+ \$442
6 Tapered legs*	29"	79 1/4"	34"	TBRCT3479T	\$3,160	\$3,476	\$3,792	+ \$315	+ \$442
6 Tapered legs*	29"	83 3/4"	41 3/4"	TBRCT4284T	\$3,475	\$3,823	\$4,170	+ \$315	+ \$442
6 Tapered legs*	29"	95 3/4"	47 3/4"	TBRCT4896T	\$3,601	\$3,961	\$4,321	+ \$315	+ \$442

* Includes a support rail

Options for Rectangle Tables

DESCRIPTION	OPTION CODE	Y BASE	TAPERED LEGS	UPCHARGE
Bar height	BH	•		+ \$379
Casters (set of 4)	C	•	•	+ \$126
Flip top	FT	•		+ \$379

Specify

1. Model #
2. Options
3. Laminate
4. Edge band
5. Base paint

Grain Direction

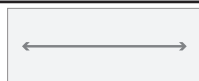

TB	Table	Shape	D	W	Base
		R Round	34	69	Y Y base
		S Square			T Tapered legs
		RCT Rectangle			
		OT Oval			
TB		RCT	34	69	Y

Desks

C-Legs and O-Legs



C-Legs – 24" D

H	W	D	MODEL #	SUPPORT RAIL	LAMINATE			PAINT	
					L1	L2	L3	P2	P3
29"	42"	24"	TBRCT2442C		\$1,348	\$1,398	\$1,449	+ \$88	+ \$170
29"	48"	24"	TBRCT2448C		\$1,347	\$1,426	\$1,479	+ \$88	+ \$170
29"	54"	24"	TBRCT2454C	•	\$1,500	\$1,582	\$1,639	+ \$88	+ \$170
29"	60"	24"	TBRCT2460C	•	\$1,569	\$1,658	\$1,722	+ \$88	+ \$170
29"	66"	24"	TBRCT2466C	•	\$1,633	\$1,729	\$1,799	+ \$88	+ \$170
29"	72"	24"	TBRCT2472C	•	\$1,645	\$1,742	\$1,813	+ \$88	+ \$170

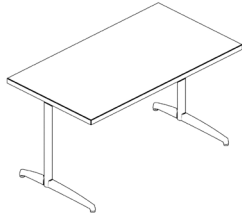

C-Legs – 30" D

H	W	D	MODEL #	SUPPORT RAIL	LAMINATE			PAINT	
					L1	L2	L3	P2	P3
29"	42"	30"	TBRCT3042C		\$1,504	\$1,564	\$1,624	+ \$93	+ \$187
29"	48"	30"	TBRCT3048C		\$1,522	\$1,583	\$1,645	+ \$93	+ \$187
29"	54"	30"	TBRCT3054C	•	\$1,738	\$1,809	\$1,881	+ \$93	+ \$187
29"	60"	30"	TBRCT3060C	•	\$1,795	\$1,872	\$1,950	+ \$93	+ \$187
29"	66"	30"	TBRCT3066C	•	\$1,846	\$1,928	\$2,011	+ \$93	+ \$187
29"	72"	30"	TBRCT3072C	•	\$1,890	\$1,977	\$2,064	+ \$93	+ \$187

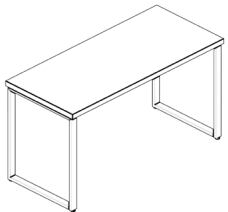

O-Legs – 24" D

H	W	D	MODEL #	SUPPORT RAIL	LAMINATE			PAINT	
					L1	L2	L3	P2	P3
29"	42"	24"	TBRCT2442O		\$1,952	\$2,002	\$2,053	+ \$148	+ \$297
29"	48"	24"	TBRCT2448O		\$1,977	\$2,030	\$2,083	+ \$148	+ \$297
29"	54"	24"	TBRCT2454O	•	\$2,130	\$2,186	\$2,243	+ \$148	+ \$297
29"	60"	24"	TBRCT2460O	•	\$2,199	\$2,262	\$2,326	+ \$148	+ \$297
29"	66"	24"	TBRCT2466O	•	\$2,263	\$2,333	\$2,403	+ \$148	+ \$297
29"	72"	24"	TBRCT2472O	•	\$2,275	\$2,346	\$2,417	+ \$148	+ \$297

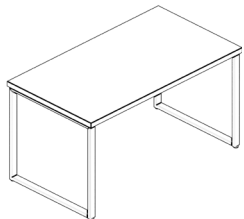

O-Legs – 30" D

H	W	D	MODEL #	SUPPORT RAIL	LAMINATE			PAINT	
					L1	L2	L3	P2	P3
29"	42"	30"	TBRCT3042O		\$2,071	\$2,131	\$2,191	+ \$154	+ \$302
29"	48"	30"	TBRCT3048O		\$2,063	\$2,150	\$2,212	+ \$154	+ \$302
29"	54"	30"	TBRCT3054O	•	\$2,279	\$2,376	\$2,448	+ \$154	+ \$302
29"	60"	30"	TBRCT3060O	•	\$2,336	\$2,439	\$2,517	+ \$154	+ \$302
29"	66"	30"	TBRCT3066O	•	\$2,387	\$2,495	\$2,578	+ \$154	+ \$302
29"	72"	30"	TBRCT3072O	•	\$2,431	\$2,544	\$2,631	+ \$154	+ \$302

Free Standing

Specify

1. Model #
2. Options
3. Laminate
4. Edge band
5. Base paint

Grain Direction

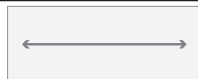

TB	Table	RCT	Rectangle	D	W	Base
TB		RCT		24	60	C C-Leg O O-Leg
TB		RCT		24	60	C



T-Legs – 24" D

H	W	D	MODEL #	SUPPORT RAIL	LAMINATE			PAINT	
					L1	L2	L3	P2	P3
29"	42"	24"	TBRCT2442TL		\$1,348	\$1,398	\$1,449	+ \$88	+ \$170
29"	48"	24"	TBRCT2448TL		\$1,373	\$1,426	\$1,479	+ \$88	+ \$170
29"	54"	24"	TBRCT2454TL	•	\$1,526	\$1,582	\$1,639	+ \$88	+ \$170
29"	60"	24"	TBRCT2460TL	•	\$1,595	\$1,658	\$1,722	+ \$88	+ \$170
29"	66"	24"	TBRCT2466TL	•	\$1,659	\$1,729	\$1,799	+ \$88	+ \$170
29"	72"	24"	TBRCT2472TL	•	\$1,671	\$1,742	\$1,813	+ \$88	+ \$170



T-Legs – 30" D

H	W	D	MODEL #	SUPPORT RAIL	LAMINATE			PAINT	
					L1	L2	L3	P2	P3
29"	42"	30"	TBRCT3042TL		\$1,491	\$1,551	\$1,611	+ \$93	+ \$181
29"	48"	30"	TBRCT3048TL		\$1,509	\$1,570	\$1,632	+ \$93	+ \$181
29"	54"	30"	TBRCT3054TL	•	\$1,725	\$1,796	\$1,868	+ \$93	+ \$181
29"	60"	30"	TBRCT3060TL	•	\$1,782	\$1,859	\$1,937	+ \$93	+ \$181
29"	66"	30"	TBRCT3066TL	•	\$1,833	\$1,915	\$1,998	+ \$93	+ \$181
29"	72"	30"	TBRCT3072TL	•	\$1,877	\$1,964	\$2,051	+ \$93	+ \$181

Options for Desks

DESCRIPTION	OPTION CODE	C-LEGS	O-LEGS	T-LEGS	UPCHARGE
Bar height	BH	•		•	+ \$379
Casters; Carpet (set of 4)	C0	•		•	+ \$126
Casters; Hardfloor (set of 4)	C1	•		•	+ \$126
Flip top	FT	•		•	+ \$379

Ganging Kit for Desks

DESCRIPTION	OPTION CODE	C-LEGS	O-LEGS	T-LEGS	UPCHARGE
Ganging Kit - connects 2 desks together	DSKGK	•		•	\$70

Specify

1. Model #
2. Options
3. Laminate
4. Edge band
5. Base paint

Grain Direction

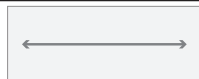

Shape	D	W	Base	
TB Table	RCT Rectangle	24	60	TL T-Leg
TB	RCT	24	60	TL

Sit/Stand Desks

Electric Height Adjustable

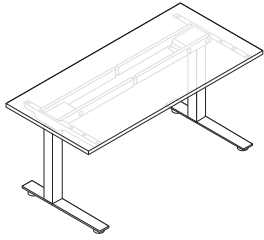

24" D

H	W	D	MODEL #	LAMINATE			WOOD VENEER		
				L1	L2	L3	W1	W2	W3
24" – 50"	48"	24"	TBRCT2448H	\$2,751	\$3,026	\$3,301	\$3,283	\$3,611	\$3,939
24" – 50"	54"	24"	TBRCT2454H	\$2,815	\$3,097	\$3,378	\$3,384	\$3,723	\$4,061
24" – 50"	60"	24"	TBRCT2460H	\$2,877	\$3,165	\$3,452	\$3,515	\$3,867	\$4,218
24" – 50"	66"	24"	TBRCT2466H	\$2,941	\$3,235	\$3,529	\$3,643	\$4,007	\$4,371
24" – 50"	72"	24"	TBRCT2472H	\$3,004	\$3,304	\$3,605	\$3,718	\$4,089	\$4,462
24" – 50"	78"	24"	TBRCT2478H	\$3,067	\$3,374	\$3,680	\$3,801	\$4,181	\$4,561
24" – 50"	84"	24"	TBRCT2484H	\$3,130	\$3,443	\$3,756	\$3,876	\$4,264	\$4,651

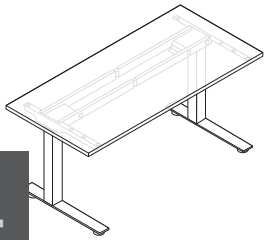

30" D

H	W	D	MODEL #	LAMINATE			WOOD VENEER		
				L1	L2	L3	W1	W2	W3
24" – 50"	48"	30"	TBRCT3048H	\$2,815	\$3,097	\$3,378	\$3,435	\$3,779	\$4,122
24" – 50"	54"	30"	TBRCT3054H	\$2,877	\$3,165	\$3,452	\$3,598	\$3,958	\$4,317
24" – 50"	60"	30"	TBRCT3060H	\$2,941	\$3,235	\$3,529	\$3,719	\$4,091	\$4,463
24" – 50"	66"	30"	TBRCT3066H	\$3,004	\$3,304	\$3,605	\$3,833	\$4,216	\$4,600
24" – 50"	72"	30"	TBRCT3072H	\$3,067	\$3,374	\$3,680	\$3,940	\$4,334	\$4,728
24" – 50"	78"	30"	TBRCT3078H	\$3,130	\$3,443	\$3,756	\$4,028	\$4,431	\$4,834
24" – 50"	84"	30"	TBRCT3084H	\$3,194	\$3,513	\$3,833	\$4,143	\$4,557	\$4,972

Free Standing

Specify

1. Model #
2. Laminate
3. Edge band
4. Support color
Black or Silver

Grain Direction

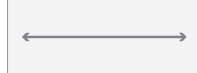

Application Notes

Electric Height Adjustable Base

Adjustable height bases can be used with 24" & 30" deep worksurfaces. Worksurfaces must be between 48" – 84" wide.

Adjustable height bases have a capacity of 264 lbs evenly distributed.

Comes with four position memory controller.

Anti-collision stops and reverses the travel of the table when the table collides with a fixed object during operation.

3-stage legs offer a large height adjustment range of 24" – 50".

Sit/Stand Desks

Stand-biased



24" D

H	W	D	MODEL #	SUPPORT RAIL	LAMINATE			PAINT	
					L1	L2	L3	P2	P3
37"	42"	24"	TBRCT2428SB		\$1,919	\$1,969	\$2,020	+\$148	+\$297
37"	48"	24"	TBRCT2448SB		\$1,944	\$1,997	\$2,050	+\$148	+\$297
37"	54"	24"	TBRCT2454SB	•	\$2,097	\$2,153	\$2,210	+\$148	+\$297
37"	60"	24"	TBRCT2460SB	•	\$2,166	\$2,229	\$2,293	+\$148	+\$297
37"	66"	24"	TBRCT2466SB	•	\$2,230	\$2,300	\$2,370	+\$148	+\$297
37"	72"	24"	TBRCT2472BS	•	\$2,242	\$2,313	\$2,384	+\$148	+\$297

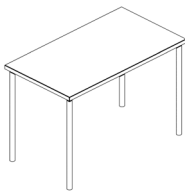

30" D

H	W	D	MODEL #	SUPPORT RAIL	LAMINATE			PAINT	
					L1	L2	L3	P2	P3
37"	42"	30"	TBRCT3042SB		\$2,014	\$2,074	\$2,134	+\$148	+\$297
37"	48"	30"	TBRCT3048SB		\$2,032	\$2,093	\$2,155	+\$148	+\$297
37"	54"	30"	TBRCT3054SB	•	\$2,248	\$2,319	\$2,391	+\$148	+\$297
37"	60"	30"	TBRCT3060SB	•	\$2,305	\$2,382	\$2,460	+\$148	+\$297
37"	66"	30"	TBRCT3066SB	•	\$2,356	\$2,438	\$2,521	+\$148	+\$297
37"	72"	30"	TBRCT3072SB	•	\$2,400	\$2,487	\$2,574	+\$148	+\$297

Free Standing

Specify	Grain Direction	Shape	D	W	Base	
1. Model # 2. Options 3. Laminate 4. Edge band 5. Base paint		TB Table RCT Rectangle	24	60	SB Stand-biased	
		TB	RCT	24	60	SB

Pricing is for P1 paint base colors. Add the appropriate upcharge if using P2 or P3.

Sit/Stand Packages

1000 Series

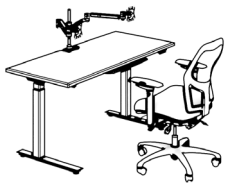

Height Adjustable

MODEL #	FINISHES		LIST
	CHAIR	DESK	
SSWSP1500-MTL-HAT-MPL	Cloud 9 – Metal	Maple w/silver legs	\$5,879
SSWSP1500-INK-HAT-MPL	Cloud 9 – Ink	Maple w/silver legs	\$5,879
SSWSP1500-EBY-HAT-MPL	Cloud 9 – Ebony	Maple w/silver legs	\$5,879
SSWSP1500-MTL-HAT-CHR	Cloud 9 – Metal	Cherry w/black legs	\$6,173
SSWSP1500-INK-HAT-CHR	Cloud 9 – Ink	Cherry w/black legs	\$6,173
SSWSP1500-EBY-HAT-CHR	Cloud 9 – Ebony	Cherry w/black legs	\$6,173



Height Adjustable w/Screens

MODEL #	FINISHES		LIST
	CHAIR	DESK	
SSWSP1500-MTL-HATWS-MPL	Cloud 9 – Metal	Maple w/silver legs	\$7,863
SSWSP1500-INK-HATWS-MPL	Cloud 9 – Ink	Maple w/silver legs	\$7,863
SSWSP1500-EBY-HATWS-MPL	Cloud 9 – Ebony	Maple w/silver legs	\$7,863
SSWSP1500-MTL-HATWS-CHR	Cloud 9 – Metal	Cherry w/black legs	\$8,067
SSWSP1500-INK-HATWS-CHR	Cloud 9 – Ink	Cherry w/black legs	\$8,067
SSWSP1500-EBY-HATWS-CHR	Cloud 9 – Ebony	Cherry w/black legs	\$8,067

Free Standing



Stand-biased

MODEL #	FINISHES		LIST
	CHAIR	DESK	
SSWSP1500-MTL-STB-MPL	Cloud 9 – Metal	Maple w/silver legs	\$6,101
SSWSP1500-INK-STB-MPL	Cloud 9 – Ink	Maple w/silver legs	\$6,101
SSWSP1500-EBY-STB-MPL	Cloud 9 – Ebony	Maple w/silver legs	\$6,101
SSWSP1500-MTL-STB-CHR	Cloud 9 – Metal	Cherry w/black legs	\$6,030
SSWSP1500-INK-STB-CHR	Cloud 9 – Ink	Cherry w/black legs	\$6,030
SSWSP1500-EBY-STB-CHR	Cloud 9 – Ebony	Cherry w/black legs	\$6,030

Freight is not included for sit/stand packages. For sit/stand package discount information contact your Customer Service Representative at customerservice@neutralposture.com or 979.778.0502 ext. 301

Specify	Height Adjustable	Stand-biased	Application Notes	
1. Model #	Included <ul style="list-style-type: none"> • 1000 Series Chair • 60 x 30 Desk • Dual Monitor Arms • Keyboard Arm & Tray 	Included <ul style="list-style-type: none"> • 1000 Series Chair • 60 x 30 Desk • Dual Monitor Arms • Keyboard Arm & Tray • N-Position 	Electric Height Adjustable Base Adjustable height bases have a capacity of 264 lbs evenly distributed. Comes with four position memory controller.	Anti-collision stops and reverses the travel of the table when the table collides with a fixed object during operation. 3-stage legs offer a large height adjustment range of 24" – 50".

Height Adjustable



MODEL #	FINISHES		LIST
	CHAIR	DESK	
SSWSP8500-MTL-HAT-MPL	Cloud 9 – Metal	Maple w/silver legs	\$6,012
SSWSP8500-INK-HAT-MPL	Cloud 9 – Ink	Maple w/silver legs	\$6,012
SSWSP8500-EBY-HAT-MPL	Cloud 9 – Ebony	Maple w/silver legs	\$6,012
SSWSP8500-MTL-HAT-CHR	Cloud 9 – Metal	Cherry w/black legs	\$6,306
SSWSP8500-INK-HAT-CHR	Cloud 9 – Ink	Cherry w/black legs	\$6,306
SSWSP8500-EBY-HAT-CHR	Cloud 9 – Ebony	Cherry w/black legs	\$6,306

Height Adjustable w/Screens



MODEL #	FINISHES		LIST
	CHAIR	DESK	
SSWSP8500-MTL-HATWS-MPL	Cloud 9 – Metal	Maple w/silver legs	\$7,996
SSWSP8500-INK-HATWS-MPL	Cloud 9 – Ink	Maple w/silver legs	\$7,996
SSWSP8500-EBY-HATWS-MPL	Cloud 9 – Ebony	Maple w/silver legs	\$7,996
SSWSP8500-MTL-HATWS-CHR	Cloud 9 – Metal	Cherry w/black legs	\$8,200
SSWSP8500-INK-HATWS-CHR	Cloud 9 – Ink	Cherry w/black legs	\$8,200
SSWSP8500-EBY-HATWS-CHR	Cloud 9 – Ebony	Cherry w/black legs	\$8,200

Stand-biased

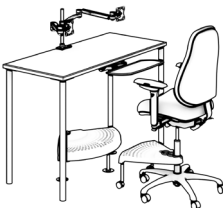

MODEL #	FINISHES		LIST
	CHAIR	DESK	
SSWSP8500-MTL-STB-MPL	Cloud 9 – Metal	Maple w/silver legs	\$6,234
SSWSP8500-INK-STB-MPL	Cloud 9 – Ink	Maple w/silver legs	\$6,234
SSWSP8500-EBY-STB-MPL	Cloud 9 – Ebony	Maple w/silver legs	\$6,234
SSWSP8500-MTL-STB-CHR	Cloud 9 – Metal	Cherry w/black legs	\$6,163
SSWSP8500-INK-STB-CHR	Cloud 9 – Ink	Cherry w/black legs	\$6,163
SSWSP8500-EBY-STB-CHR	Cloud 9 – Ebony	Cherry w/black legs	\$6,163

Freight is not included for sit/stand packages. For sit/stand package discount information contact your Customer Service Representative at customerservice@neutralposture.com or 979.778.0502 ext. 301

Specify	Height Adjustable	Stand-biased	Application Notes	
1. Model #	Included <ul style="list-style-type: none"> • 8000 Series Chair • 60 x 30 Desk • Dual Monitor Arms • Keyboard Arm & Tray 	Included <ul style="list-style-type: none"> • 8000 Series Chair • 60 x 30 Desk • Dual Monitor Arms • Keyboard Arm & Tray • N-Position 	Electric Height Adjustable Base Adjustable height bases have a capacity of 264 lbs evenly distributed. Comes with four position memory controller.	Anti-collision stops and reverses the travel of the table when the table collides with a fixed object during operation. 3-stage legs offer a large height adjustment range of 24" – 50".

Screens

Privacy/Modesty Panels

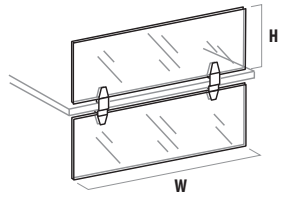

Privacy & Modesty Panels

W	H	BRACKETS	MODEL #	SCREEN TYPE		
				PG	CR	TC
12"	12"	2	PRVMOD(CR/PG/TC)12	\$355	\$403	\$861
18"	12"	2	PRVMOD(CR/PG/TC)18	\$403	\$500	\$1,176
24"	12"	2	PRVMOD(CR/PG/TC)24	\$475	\$596	\$1,489
30"	12"	2	PRVMOD(CR/PG/TC)30	\$548	\$693	\$1,804
36"	12"	2	PRVMOD(CR/PG/TC)36	\$620	\$790	\$2,142
42"	12"	2	PRVMOD(CR/PG/TC)42	\$693	\$886	\$2,455
48"	12"	2	PRVMOD(CR/PG/TC)48	\$764	\$983	\$2,770
60"	12"	3	PRVMOD(CR/PG/TC)60	\$909	\$1,224	\$3,421

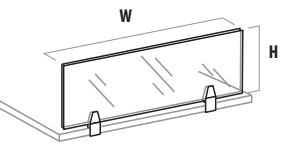

Privacy Panels

12"	12"	2	PRV(CR/PG/TC)12	\$177	\$202	\$431
18"	12"	2	PRV(CR/PG/TC)18	\$202	\$250	\$588
24"	12"	2	PRV(CR/PG/TC)24	\$237	\$298	\$744
30"	12"	2	PRV(CR/PG/TC)30	\$274	\$347	\$902
36"	12"	2	PRV(CR/PG/TC)36	\$310	\$395	\$1,071
42"	12"	2	PRV(CR/PG/TC)42	\$347	\$443	\$1,227
48"	12"	2	PRV(CR/PG/TC)48	\$382	\$491	\$1,385
60"	12"	3	PRV(CR/PG/TC)60	\$455	\$612	\$1,710

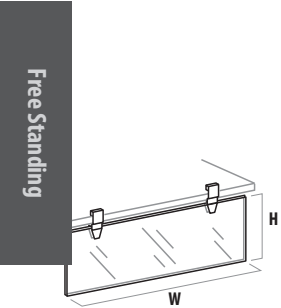

Modesty Panels

12"	12"	2	MOD(CR/PG/TC)12	\$177	\$202	\$431
18"	12"	2	MOD(CR/PG/TC)18	\$202	\$250	\$588
24"	12"	2	MOD(CR/PG/TC)24	\$237	\$298	\$744
30"	12"	2	MOD(CR/PG/TC)30	\$274	\$347	\$902
36"	12"	2	MOD(CR/PG/TC)36	\$310	\$395	\$1,071
42"	12"	2	MOD(CR/PG/TC)42	\$347	\$443	\$1,227
48"	12"	2	MOD(CR/PG/TC)48	\$382	\$491	\$1,385
60"	12"	3	MOD(CR/PG/TC)60	\$455	\$612	\$1,710

Free Standing

Specify	Screen Type	Corian Finishes	Textured Corian Finishes	Plexiglass Finishes
1. Model #	CR . Corian	Glacier White . . . CR001	Glacier White . . . CR001T	IC . . . Ice
2. Insert type	PG . Plexiglass	Pearl Grey CR002	Pearl Grey CR002T	SM . . Smoked
3. Insert color	TC . Textured Corian	Corian Clay CR003	Corian Clay CR003T	TR . . Translucent
		Silver Grey CR004	Silver Grey CR004T	LF . . Frost
		Corian Grey CR005	Corian Grey CR005T	

Trim - Brushed nickel only

Application Notes

Screens are ¼" thick.
Widths are 1" less than nominal to allow for ½" set-back on each side.

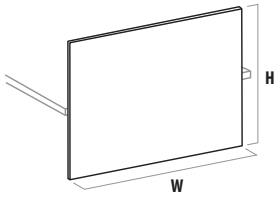

Privacy & Modesty Panels — fabric

W	H	BRACKETS	MODEL #	FABRIC							
				A	B	C	D	E	F	G	H
24"	27"	2	PRVMODFA24	\$431	\$481	\$511	\$531	\$641	\$761	\$871	\$971
30"	27"	2	PRVMODFA30	\$455	\$525	\$555	\$575	\$685	\$805	\$905	\$1,015
36"	27"	2	PRVMODFA36	\$479	\$569	\$599	\$619	\$729	\$849	\$949	\$1,059
42"	27"	2	PRVMODFA42	\$503	\$603	\$643	\$663	\$773	\$883	\$993	\$1,103
48"	27"	2	PRVMODFA48	\$588	\$708	\$748	\$758	\$878	\$998	\$1,088	\$1,208
60"	27"	3	PRVMODFA60	\$744	\$874	\$924	\$934	\$1,034	\$1,164	\$1,264	\$1,374

Free Standing

Specify	Screen Type	Corian Finishes	Textured Corian Finishes	Plexiglass Finishes
1. Model #	CR . . Corian	Glacier White . . . CR001	Glacier White . . . CR001T	IC . . . Ice
2. Insert type	PG . . Plexiglass	Pearl Grey CR002	Pearl Grey CR002T	SM . . Smoked
3. Insert color	TC . . Textured Corian	Corian Clay CR003	Corian Clay CR003T	TR . . Translucent
		Silver Grey CR004	Silver Grey CR004T	LF . . Frost
		Corian Grey CR005	Corian Grey CR005T	
Trim - Brushed nickel only				Application Notes
				Screens are ¼" thick.
				Widths are 1" less than nominal to allow for ½" set-back on each side.

Screens

Desktop



18" H

W	MODEL #	INSERT		
		PG	PAINT	
			P2	P3
12"	EDTS() 1218 ()	\$431	+ \$30	+ \$60
18"	EDTS() 1818 ()	\$455	+ \$30	+ \$60
24"	EDTS() 2418 ()	\$479	+ \$30	+ \$60
30"	EDTS() 3018 ()	\$503	+ \$30	+ \$60
36"	EDTS() 3618 ()	\$527	+ \$30	+ \$60
42"	EDTS() 4218 ()	\$551	+ \$30	+ \$60
48"	EDTS() 4818 ()	\$575	+ \$30	+ \$60

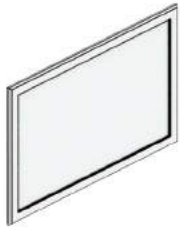

24" H

12"	EDTS() 1224 ()	\$455	+ \$30	+ \$60
18"	EDTS() 1824 ()	\$479	+ \$30	+ \$60
24"	EDTS() 2424 ()	\$503	+ \$30	+ \$60
30"	EDTS() 3024 ()	\$527	+ \$30	+ \$60
36"	EDTS() 3624 ()	\$551	+ \$30	+ \$60
42"	EDTS() 4224 ()	\$575	+ \$30	+ \$60
48"	EDTS() 4824 ()	\$600	+ \$30	+ \$60
60"	EDTS() 6024 ()	\$660	+ \$30	+ \$60



30" H

12"	EDTS() 1230 ()	\$527	+ \$30	+ \$60
18"	EDTS() 1830 ()	\$551	+ \$30	+ \$60
24"	EDTS() 2430 ()	\$575	+ \$30	+ \$60
30"	EDTS() 3030 ()	\$600	+ \$30	+ \$60
36"	EDTS() 3630 ()	\$624	+ \$30	+ \$60
42"	EDTS() 4230 ()	\$648	+ \$30	+ \$60
48"	EDTS() 4830 ()	\$672	+ \$30	+ \$60

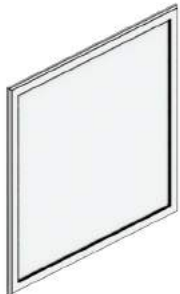

36" H

12"	EDTS() 1236 ()	\$624	+ \$30	+ \$60
18"	EDTS() 1836 ()	\$648	+ \$30	+ \$60
24"	EDTS() 2436 ()	\$672	+ \$30	+ \$60
30"	EDTS() 3036 ()	\$696	+ \$30	+ \$60
36"	EDTS() 3636 ()	\$720	+ \$30	+ \$60
42"	EDTS() 4236 ()	\$744	+ \$30	+ \$60
48"	EDTS() 4836 ()	\$769	+ \$30	+ \$60

Specify

1. Model #
2. Insert type
3. Insert color
4. Paint

		W	H	Mounting		
EDTS	Equity Desktop Screen	PG	Plexiglass Insert	36	18	C Clamp \$60
						F Freestanding \$0
						S Screw down \$0
EDTS		PG		36	18	F



61" H

W	MODEL #	INSERT	PAINT	
		PG	P2	P3
24"	EMS()2461	\$2,061	+ \$30	+ \$60
30"	EMS()3061	\$2,363	+ \$30	+ \$60
36"	EMS()3661	\$2,725	+ \$30	+ \$60
42"	EMS()4261	\$3,087	+ \$30	+ \$60
48"	EMS()4861	\$3,329	+ \$30	+ \$60



64" H

24"	EMS()2464	\$2,182	+ \$30	+ \$60
30"	EMS()3064	\$2,544	+ \$30	+ \$60
36"	EMS()3664	\$2,906	+ \$30	+ \$60
42"	EMS()4264	\$3,269	+ \$30	+ \$60
48"	EMS()4864	\$3,570	+ \$30	+ \$60



81" H

24"	EMS()2481	\$2,786	+ \$30	+ \$60
30"	EMS()3081	\$3,389	+ \$30	+ \$60
36"	EMS()3681	\$3,872	+ \$30	+ \$60
42"	EMS()4281	\$4,355	+ \$30	+ \$60
48"	EMS()4881	\$4,718	+ \$30	+ \$60

Free Standing

Specify

1. Model #
2. Insert type
3. Insert color
4. Paint

						Options	
EMS	Equity Mobile Screen	PG	Plexiglass Insert	W	H		
				36	81	C	Casters \$120
EMS		PG		36	81		

STORAGE

Neutral Posture is not only dedicated to good posture, we are also dedicated to making offices more efficient and more enjoyable to work in. Neutral Posture knows that to increase efficiency in the office things must be organized well and be easily accessible. Neutral Posture offers the most space efficient and easily accessible products on the market.

Neutral Posture offers many diverse storage units making sure you can always find the exact unit of storage for your office's needs. From small pedestals that can double as seating to large towers with wardrobe capability, Neutral Posture can fit your needs in any situation. Along with our wide range of storage options, Neutral Posture also lets you truly personalize your office equipment, making your office a welcoming place for not only your customers, but, your employees as well.

Neutral Posture provides storage units that work together—meaning that they will work better for you and your workspace. Neutral Posture allows customization by offering several different color options, fabric patterns and even several different pulls and lock options to make sure your office space looks exactly how you want. Storage units that are cohesive have numerous benefits, such as taking up less space, being easier to access and making your office look more unified.

TRUE DIMENSIONS

Disclaimer: While Equity panels and worksurfaces are based on centerline to centerline dimensions, all storage dimensions are true dimensions.



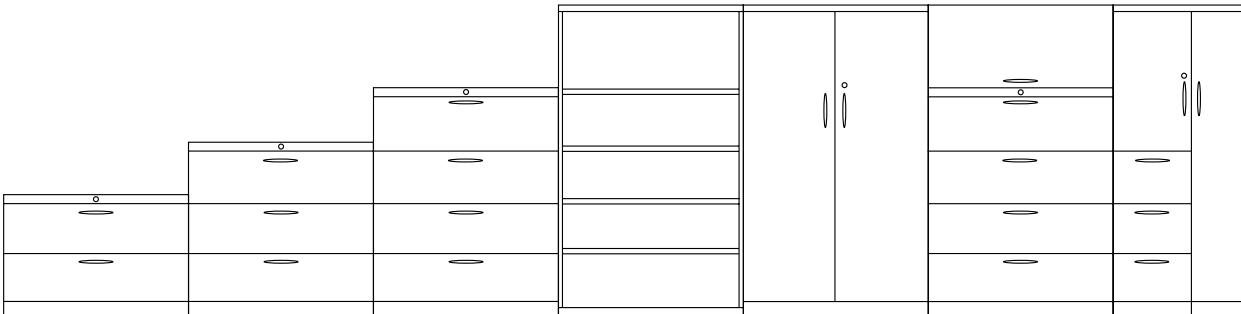





STORAGE

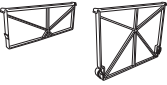

Storage

Storage

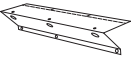
Accessory Availability

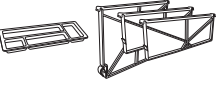
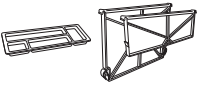
	PEDESTALS	LATERALS	TOWERS	CRENZAS	CABINETS	LOCKERS	BOOKCASES
 Pencil tray	•	•	•				
 Drawer dividers	•		•				
 Magnetic label	•	•	•	•			
 Ped drawer front filler	•		•				
 Magnetic drawer dividers		•		•			
 Magnetic shelf divider		•	•	•	•		•
 Lateral file conversion bar		•					
 Worksurface supporting bracket			•				
 Ped accessory package – FF	•		•				
 Ped accessory package – BBF	•		•				
 Ped accessory package – BF	•						

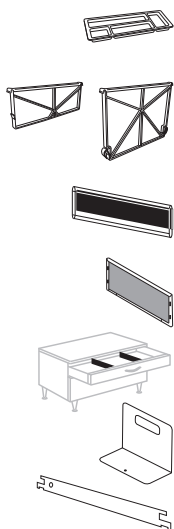

	MODEL #	LIST
Pencil tray	SPTRY	\$20
6" Drawer divider	SBDD	\$20
12" Drawer divider	SFDD	\$46
Magnetic label	SMLB	\$84
Ped drawer front filler	SPFF	\$82
Magnetic drawer dividers	SMDDB	\$121
Magnetic shelf divider	SMSD	\$96
Lateral file conversion bar	SLFCB	\$96

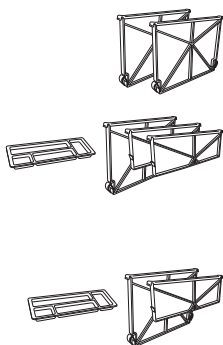

PED ACCESSORY PACKAGE – FF

2 – 12" Drawer dividers	SFFA	\$84
-------------------------	-------------	------

PED ACCESSORY PACKAGE – BBF

2 – 6" Drawer dividers	SBBFA	\$96
1 – 12" Drawer dividers		
1 – Pencil tray		

PED ACCESSORY PACKAGE – BF

1 – 6" Drawer divider	SBFA	\$84
1 – 12" Drawer divider		
1 – Pencil tray		

Pedestals

General Info

Step 1 – Model

Pedestal	Drawers	D	Pull
SPED Freestanding Pedestal	FF File File	19	J J Pull
SMPED Mobile Pedestal	BBF Box Box File		B Bar Pull
SCMPED Mobile Pedestal w/Cushion	BF Box File		R Radiused Pull
SSPED Suspended Pedestal			
SWSPED Worksurface Supporting Pedestal			
SWSLKR Worksurface Supporting Locker			
SFC File Center			
SPED	BBF	19	B

Step 2 – Case Finish

Paint
301 Champagne
301

Step 3 – Front Finish

Not Available w/J Pull	
Laminate	
PW-STK	Studio Teak
PW-STK	

FEATURES

COUNTER WEIGHTS

- Freestanding, mobile and cushion pedestals include factory installed counterweights.
- Counterweights are not necessary for worksurface supporting or suspended pedestals.

LOCK

- Lock core is removable.
- Keyed alike available upon request.
- Master and change key available upon request. See (page 9).
- Individual locking drawers available upon request. Upcharge may apply.

DRAWERS

- Include full suspension steel ball-bearing slides.
- Drawer fronts include rubber bumpers for quiet operation.

LEVELING GLIDES

- 4 Leveling glides allow for 1 5/8" adjustment.

CASTERS – MOBILE PEDS

- 4 Black casters, 2 of which are locking.

CONSTRUCTION

OUTER SHELL & DRAWER CONSTRUCTION

Welded steel frame construction & formed channels ensure strength in key areas.

Top channels	18 – 21 Gauge
Side channels	18 – 21 Gauge
Outer panels	22 Gauge
Drawer fronts	20 Gauge
Drawer bins	22 Gauge

DRAWER LOAD CAPACITY

6" Box drawers	50 lbs
12" File drawers	70 lbs

DRAWER INNER DIMENSIONS

Height	
Box drawer	4 1/2"
File drawer	9 1/2"

Width

All drawers	12 1/8"
-------------	---------

Depth

18" Deep pedestal	15 1/5"
22" Deep pedestal	18 1/4"
30" Deep pedestal	24 1/4"

PULL STYLES

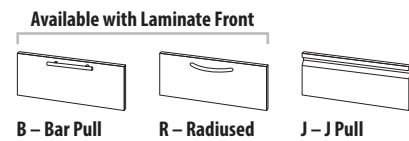

SURFACE MATERIALS

PEDESTAL

Paint

FRONTS

w/Bar pull (B)	Paint or Laminate
w/Radiused pull (R)	Paint or Laminate
w/J pull (J)	Paint

DRAWER PULL

Bar (B)	Satin nickel
Radiused (R)	Satin nickel
J (J)	Paint

MOBILE PED HANDLE

Satin nickel

LOCK

Satin nickel

CUSHION TOP

Upholstery

PEDESTALS

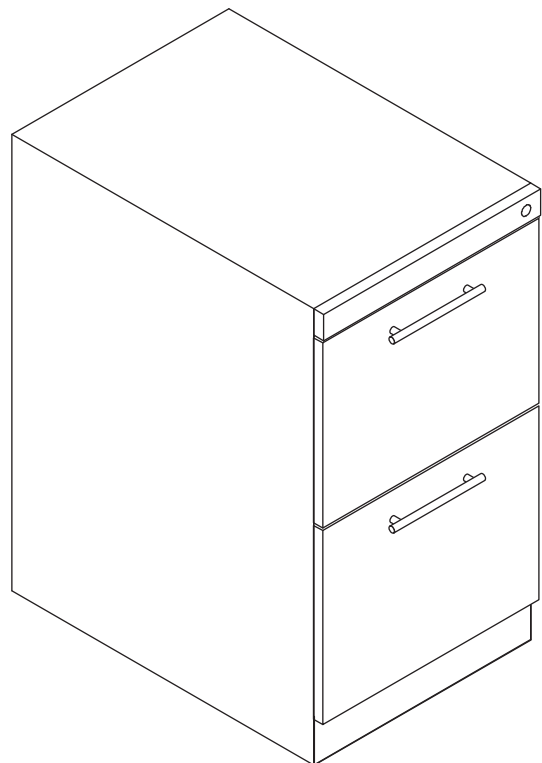

Storage

Pedestals



Freestanding

H	W	D	MODEL #	PAINT			LAMINATE FRONT (UPCHARGE)		
				P1	P2	P3	L1	L2	L3
27 3/4"	15 1/4"	21 7/8"	SPEDFF22(J/B/R)	\$753	\$828	\$903	+ \$328	+ \$360	+ \$393
27 3/4"	15 1/4"	21 7/8"	SPEDBBF22(J/B/R)	\$804	\$884	\$964	+ \$353	+ \$388	+ \$423
27 3/4"	15 1/4"	27 7/8"	SPEDFF30(J/B/R)	\$855	\$940	\$1,026	+ \$341	+ \$460	+ \$579
27 3/4"	15 1/4"	27 7/8"	SPEDBBF30(J/B/R)	\$880	\$968	\$1,056	+ \$351	+ \$473	+ \$596



Mobile

H	W	D	MODEL #	PAINT			LAMINATE FRONT (UPCHARGE)		
				P1	P2	P3	L1	L2	L3
26 7/8"	15 1/4"	18 7/8"	SMPEDFF19(J/B/R)	\$753	\$828	\$903	+ \$328	+ \$360	+ \$394
26 7/8"	15 1/4"	18 7/8"	SMPEDBBF19(J/B/R)	\$817	\$898	\$980	+ \$359	+ \$394	+ \$431
21 1/8"	15 1/4"	18 7/8"	SMPEDBF19(J/B/R)	\$728	\$800	\$873	+ \$315	+ \$346	+ \$378
26 7/8"	15 1/4"	21 7/8"	SMPEDFF22(J/B/R)	\$804	\$884	\$964	+ \$353	+ \$388	+ \$424
26 7/8"	15 1/4"	21 7/8"	SMPEDBBF22(J/B/R)	\$855	\$940	\$1,026	+ \$379	+ \$416	+ \$455
21 1/8"	15 1/4"	21 7/8"	SMPEDBF22(J/B/R)	\$741	\$815	\$889	+ \$315	+ \$346	+ \$378
26 7/8"	15 1/4"	27 7/8"	SMPEDFF30(J/B/R)	\$829	\$911	\$994	+ \$331	+ \$446	+ \$562
26 7/8"	15 1/4"	27 7/8"	SMPEDBBF30(J/B/R)	\$868	\$954	\$1,041	+ \$347	+ \$468	+ \$589
21 1/8"	15 1/4"	27 7/8"	SMPEDBF30(J/B/R)	\$767	\$843	\$920	+ \$306	+ \$413	+ \$520



Mobile Cushion

H	W	D	MODEL #	FABRIC							
				1	2	3	4	5	6	7	8
1"	15 1/4"	18 7/8"	PC19	\$227	\$257	\$287	\$317	\$387	\$447	\$507	\$597
1"	15 1/4"	21 7/8"	PC22	\$227	\$257	\$287	\$317	\$387	\$447	\$507	\$597
1"	15 1/4"	27 7/8"	PC30	\$227	\$257	\$287	\$317	\$387	\$447	\$507	\$597

Security Pedestal Upgrade

File/File (FF)	SP	+ \$530
Box/File (BF)	SP	+ \$660
Box/Box/File (BBF)	SP	+ \$790

Specify

1. Model #
2. Case finish
3. Front finish
Laminate not available on J pull

Pulls

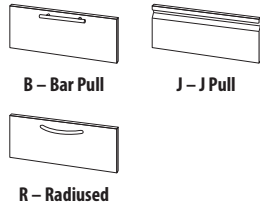

Ordered Separately

- Pencil tray

Freestanding Peds

- Included**
- Counterweight for stability
 - Leveling glides allow for 1/8" adjustment

Mobile Peds

- Included**
- Counterweight for stability
 - Black 37mm plastic casters (2 locking & 2 non-locking)

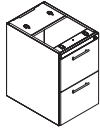

Suspended

H	W	D	MODEL #	PAINT			LAMINATE FRONT (UPCHARGE)		
				P1	P2	P3	L1	L2	L3
25"	15 1/4"	21 7/8"	SSPEDFF22(J/B/R)	\$753	\$828	\$903	+ \$328	+ \$360	+ \$394
25"	15 1/4"	21 7/8"	SSPEDBBF22(J/B/R)	\$804	\$884	\$964	+ \$353	+ \$388	+ \$424
19 3/8"	15 1/4"	21 7/8"	SSPEDBF22(J/B/R)	\$627	\$689	\$752	+ \$271	+ \$298	+ \$325



Worksurface Supporting

H	W	D	MODEL #	PAINT			LAMINATE FRONT (UPCHARGE)		
				P1	P2	P3	L1	L2	L3
27 3/4"	15 1/4"	17 7/8"	SWSPEDFF18(J/B/R)	\$728	\$800	\$873	+ \$322	+ \$354	+ \$386
27 3/4"	15 1/4"	17 7/8"	SWSPEDBBF18(J/B/R)	\$779	\$856	\$934	+ \$340	+ \$374	+ \$408
27 3/4"	15 1/4"	21 7/8"	SWSPEDFF22(J/B/R)	\$728	\$800	\$873	+ \$322	+ \$354	+ \$386
27 3/4"	15 1/4"	21 7/8"	SWSPEDBBF22(J/B/R)	\$779	\$856	\$934	+ \$340	+ \$374	+ \$408
27 3/4"	15 1/4"	27 7/8"	SWSPEDFF30(J/B/R)	\$753	\$828	\$903	+ \$301	+ \$406	+ \$511
27 3/4"	15 1/4"	27 7/8"	SWSPEDBBF30(J/B/R)	\$829	\$911	\$994	+ \$331	+ \$446	+ \$562



Mobile Slim

DRAWER ACCESS	H	W	D	MODEL #	PAINT			LAMINATE FRONT (UPCHARGE)		
					P1	P2	P3	L1	L2	L3
L	20"	12"	18 7/8"	SMPEDSLM19L(J/B/R)	\$1,385	\$1,523	\$1,662	+ \$353	+ \$388	+ \$424
R	20"	12"	18 7/8"	SMPEDSLM19R(J/B/R)	\$1,385	\$1,523	\$1,662	+ \$353	+ \$388	+ \$424
Both	20"	12"	18 7/8"	SMPEDSLM19B(J/B/R)	\$1,449	\$1,593	\$1,738	+ \$353	+ \$388	+ \$424



Mobile Slim Cushion

H	W	D	MODEL #	FABRIC							
				1	2	3	4	5	6	7	8
1"	12"	18 7/8"	PCS19	\$227	\$257	\$287	\$317	\$387	\$447	\$507	\$597

Specify	Lateral	W	Pull	Options
1. Model # 2. Case finish 3. Front finish <i>Laminate not available on J Pull</i>	SPED Freestanding Pedestal SMPED Mobile Pedestal SCMPED Mobile Pedestal w/Cushion SSPED Suspended Pedestal SWSPED Worksurface Supporting Pedestal SWSLKR Worksurface Supporting Locker SFC File Center SPED	FF File File BBF Box Box File BF Box File BBF	19 J J Pull B Bar Pull R Radiused Pull B	DL Digital Lock \$450 DL

File Centers

General Info

Step 1 – Model

File Center	Drawers	D	Pull
SFC File Center	FF File File	19	J J Pull
SCMFC Mobile File Center w/Cushion	BBF Box Box File		B Bar Pull
	BF Box File		R Radiused Pull
SFC	BBF	19	B

Step 2 – Case Finish

Paints
301 Champagne
301

Step 3 – Front Finish

Not Available w/J Pull	
Laminate	
PW-STK	Studio Teak
PW-STK	

FEATURES

COUNTER WEIGHTS

- Freestanding file centers include factory installed counterweights.
- Counterweights are not necessary for worksurface supporting file centers.

LOCK

- Lock core is removable.
- Keyed alike available upon request.
- Master and change key available upon request. See (page 9).
- Individual locking drawers available upon request. Upcharge may apply.

DRAWERS

- Include full suspension steel ball-bearing slides.
- Drawer fronts include rubber bumpers for quiet operation.

LEVELING GLIDES

- 4 Leveling glides allow for 1 5/8" adjustment.

CASTERS – MOBILE PEDS

- 4 Black casters, 2 of which are locking

CONSTRUCTION

OUTER SHELL & DRAWER CONSTRUCTION

Welded steel frame construction & formed channels ensure strength in key areas.

Top channels	18 – 21 Gauge
Side channels	18 – 21 Gauge
Outer panels	22 Gauge
Drawer fronts	20 Gauge
Drawer bins	22 Gauge

DRAWER LOAD CAPACITY

6" Box drawers	50 lbs
12" File drawers	70 lbs

DRAWER INNER DIMENSIONS

Height	
Box drawer	4 1/2"
File drawer	9 1/2"

Width

All drawers	12 1/8"
-------------	---------

Depth

18" Deep pedestal	15 1/5"
30" Deep pedestal	26 1/4"

PULL STYLES

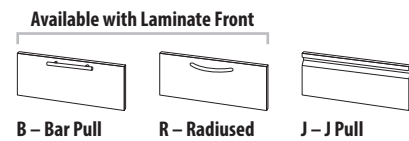

SURFACE MATERIALS

PEDESTAL

Paint

FRONTS

w/Bar pull (B)	Paint or Laminate
w/Radiused pull (R)	Paint or Laminate
w/J pull (J)	Paint

DRAWER PULL

Bar (B)	Satin nickel
Radiused (R)	Satin nickel
J (J)	Paint

LOCK

Satin nickel

CUSHION TOP

Upholstery

FILE CENTERS

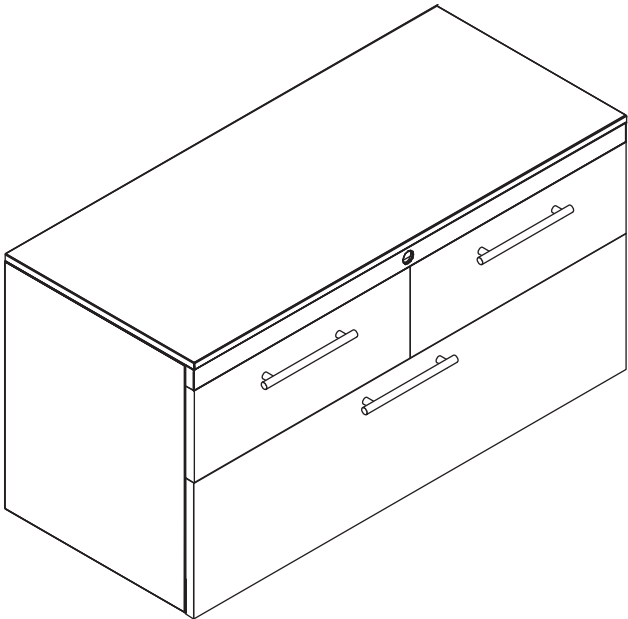

Storage

File Centers



Worksurface Supporting File Center

H	W	D	MODEL #	PAINT			LAMINATE FRONT (UPCHARGE)		
				P1	P2	P3	L1	L2	L3
27 3/4"	30 1/2"	18 1/4"	SFCFFLAT(J/B/R)	\$1,486	\$1,634	\$1,783	+\$657	+\$722	+\$788
27 3/4"	30 1/2"	18 1/4"	SFCBBFLAT(J/B/R)	\$1,500	\$1,650	\$1,800	+\$682	+\$750	+\$818
27 3/4"	30 1/2"	18 1/4"	SFCFBBLAT(J/B/R)	\$1,500	\$1,650	\$1,800	+\$682	+\$750	+\$818



Mobile File Center w/Cushion

H	W	D	MODEL #	P1	P2	P3	L1	L2	L3
24 1/8"	30 1/2"	18 3/8"	SCMFCBBLAT(J/B/R)	\$2,536	\$2,789	\$3,043	+\$884	+\$1,226	+\$1,567

Mobile Cushion Fabric Upcharges

SEATING GRADES	UPCHARGE
1	+\$225
2	+\$300
3	+\$400
4	+\$500
5	+\$600
6	+\$700
7	+\$800
8	+\$900

Specify

1. Model #
2. Case finish
3. Front finish

Laminate not available on J pull

Pulls



B – Bar Pull

J – J Pull



R – Radiused

Ordered Separately

- Pencil tray

Freestanding File Center

Included

- Counterweight for stability
- Leveling glides allow for 1 3/8" adjustment

Mobile File Center

Included

- Counterweight for stability
 - Black 37mm plastic casters (2 locking & 2 non-locking)
 - 1" cushion in black
- Other fabrics available for an upcharge.*



Mobile File Center w/Cupboard Door

HINGE	H	W	D	MODEL #	PAINT			LAMINATE FRONT (UPCHARGE)		
					P1	P2	P3	L1	L2	L3
L	22 3/8"	30 1/2"	18 1/4"	SMFCFBCUBL(J/B/R)	\$1,575	\$1,701	\$1,827	+\$682	+\$750	+\$818
R	22 3/8"	30 1/2"	18 1/4"	SMFCFBCUBR(J/B/R)	\$1,575	\$1,701	\$1,827	+\$682	+\$750	+\$818



Mobile File Center w/Open Shelf

H	W	D	MODEL #	P1	P2	P3	L1	L2	L3	
L	22 3/8"	30 1/2"	18 1/4"	SMFCFBSHFL(J/B/R)	\$1,449	\$1,701	\$1,827	+\$669	+\$735	+\$802
R	22 3/8"	30 1/2"	18 1/4"	SMFCFBSHFR(J/B/R)	\$1,449	\$1,701	\$1,827	+\$669	+\$735	+\$802



Mobile File Center Cushion

H	W	D	MODEL #	FABRIC							
				A/1	B/2	C/3	D/4	E/5	F/6	G/7	H/8
1"	30 1/2"	18 1/4"	MFCC30	\$413	\$513	\$563	\$613	\$663	\$713	\$763	\$833

Specify

1. Model #
2. Case finish
3. Front finish
Laminate not available on J Pull

Lateral				W	Pull	Options	
SFC	File Center	FF File File	19	J J Pull	DL Digital Lock	\$450	
SCMFC	Mobile File Center w/Cushion	BBF Box Box File		B Bar Pull			
		BF Box File		R Radiused Pull			
SFC		BBF	19	B	DL		

Laterals

General Info

Step 1 – Model

Lateral	# of Drawers	W	Pull
SLAT Lateral SWSLAT Worksurface Supporting	3	36	J J Pull B Bar Pull
SLAT	3	36	B

Step 2 – Case Finish

Paint
301 Champagne
301

Step 3 – Front Finish

Not Available w/J Pull	
Laminate	
PW-STK	Studio Teak
PW-STK	

FEATURES

COUNTER WEIGHTS

- Counterweights are not included with laterals.
- Counterweights are not necessary for worksurface supporting laterals.

LOCK

- Lock core is removable.
- Keyed alike available upon request.
- Master and change key available upon request. See (page 9).
- Individual locking drawers available upon request. Upcharge may apply.

DRAWERS

- All drawers include full extension steel ball-bearing slides with anti-rebound features to ensure smooth operation.
- Drawer fronts include rubber bumpers for quiet operation.
- The top opening of 5-high laterals features an over-the-top flipper door with 13 1/4" inside clear height for binder storage.
- Drawer includes full-height side panels.
- 2 file bars are included in each drawer, for side-to-side filing.
- Conversion bars for front to back filing are sold separately.
- All lateral drawer bins will accommodate A4, letter and legal size filing.

LEVELING GLIDES

4 leveling glides allow for 1 1/4" adjustment.

COUNTERWEIGHTS

- Counterweights are required for all lateral files that are not ganged together or otherwise anchored.

CONSTRUCTION

OUTER SHELL & DRAWER CONSTRUCTION

Welded steel frame construction & formed channels ensure strength in key areas. Standard depth is 18 1/4".

Inner frame	20 Gauge
Outer panels	22 Gauge
Drawer fronts	20 Gauge
Drawer bins	20 Gauge

DRAWER LOAD CAPACITY

30" Wide lateral	140 lbs
36" Wide lateral	168 lbs
42" Wide lateral	192 lbs

DRAWER INNER DIMENSIONS

Height

Top flipper door	13 1/4"
Drawer immediately below lock strip	9 2/5"
All other drawers	10 3/4"

Width

30" Wide lateral	26 7/10"
36" Wide lateral	32 7/10"
42" Wide lateral	38 7/10"

Depth

18 1/4" Deep lateral	16"
----------------------	-----

PULL STYLES

Available with Laminate Front



B – Bar Pull



J – J Pull

SURFACE MATERIALS

LATERAL

Paint

FRONTS

w/Bar pull (B)	Paint or Laminate
w/J pull (J)	Paint

DRAWER PULL

Bar (B)	Satin nickel
J (J)	Paint

LOCK

Satin nickel

TOP

Paint or Laminate

LATERALS

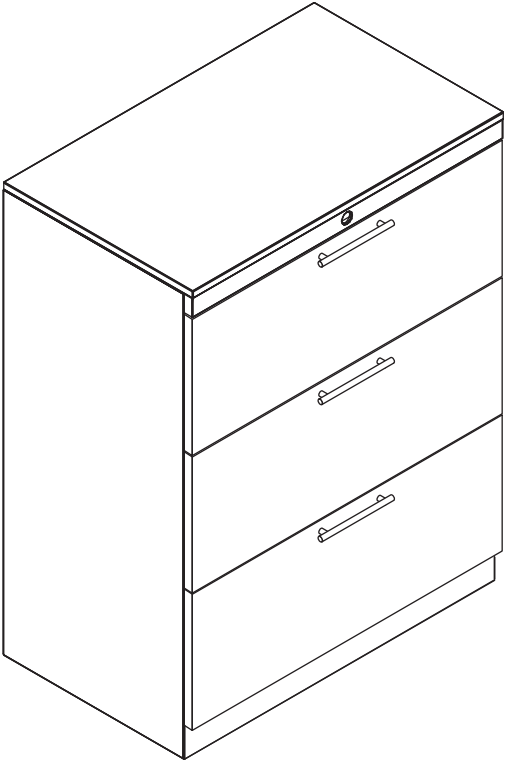

Storage

Laterals



2 Drawer

H	W	D	MODEL #	PAINT			LAMINATE FRONT (UPCHARGE)		
				P1	P2	P3	L1	L2	L3
28 3/8"	30"	18 1/4"	SLAT230(J/B)	\$1,133	\$1,246	\$1,359	+ \$505	+ \$555	+ \$666
28 3/8"	36"	18 1/4"	SLAT236(J/B)	\$1,385	\$1,523	\$1,662	+ \$556	+ \$611	+ \$733
28 3/8"	42"	18 1/4"	SLAT242(J/B)	\$1,449	\$1,593	\$1,738	+ \$606	+ \$666	+ \$799

Counterweights are required for all lateral files that are not ganged together or otherwise anchored.



3 Drawer

H	W	D	MODEL #	P1	P2	P3	L1	L2	L3
39 7/8"	30"	18 1/4"	SLAT330(J/B)	\$1,575	\$1,732	\$1,890	+ \$694	+ \$763	+ \$916
39 7/8"	36"	18 1/4"	SLAT336(J/B)	\$1,764	\$1,940	\$2,116	+ \$745	+ \$819	+ \$983
39 7/8"	42"	18 1/4"	SLAT342(J/B)	\$1,891	\$2,080	\$2,269	+ \$795	+ \$874	+ \$1,049

Counterweights are required for all lateral files that are not ganged together or otherwise anchored.



4 Drawer

H	W	D	MODEL #	P1	P2	P3	L1	L2	L3
51 3/8"	30"	18 1/4"	SLAT430(J/B)	\$1,955	\$2,150	\$2,346	+ \$846	+ \$930	+ \$1,116
51 3/8"	36"	18 1/4"	SLAT436(J/B)	\$2,144	\$2,358	\$2,572	+ \$884	+ \$972	+ \$1,166
51 3/8"	42"	18 1/4"	SLAT442(J/B)	\$2,270	\$2,497	\$2,724	+ \$922	+ \$1,014	+ \$1,217

Counterweights are required for all lateral files that are not ganged together or otherwise anchored.

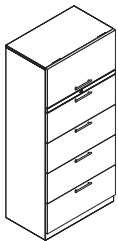

4 Drawer — w/ fixed top shelf

H	W	D	MODEL #	P1	P2	P3	L1	L2	L3
65 7/8"	30"	18 1/4"	SLAT530(J/B)	\$2,334	\$2,567	\$2,800	+ \$935	+ \$1,028	+ \$1,234
65 7/8"	36"	18 1/4"	SLAT536(J/B)	\$2,523	\$2,775	\$3,027	+ \$960	+ \$1,056	+ \$1,267
65 7/8"	42"	18 1/4"	SLAT542(J/B)	\$2,776	\$3,053	\$3,331	+ \$985	+ \$1,083	+ \$1,300

Counterweights are required for all lateral files that are not ganged together or otherwise anchored.

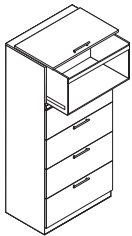

4 Drawer — w/ roll-out shelf

H	W	D	MODEL #	P1	P2	P3	L1	L2	L3
65 7/8"	30"	18 1/4"	SLAT5R30(J/B)	\$3,509	\$3,859	\$4,210	+ \$2,527	+ \$2,779	+ \$3,032
65 7/8"	36"	18 1/4"	SLAT5R36(J/B)	\$4,014	\$4,415	\$4,816	+ \$2,527	+ \$2,779	+ \$3,032
65 7/8"	42"	18 1/4"	SLAT5R42(J/B)	\$4,267	\$4,693	\$5,120	+ \$2,527	+ \$2,779	+ \$3,032

Counterweights are required for all lateral files that are not ganged together or otherwise anchored.

Specify

1. Model #
2. Case finish
3. Front finish
Laminate not available on J pull

Application Notes

- Included**
- Leveling glides for 1 3/8" adjustment

Pulls

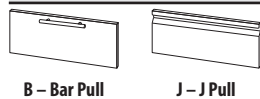

B – Bar Pull

J – J Pull

Lateral	# Drawers	W	Pull	Options		
SLAT Lateral	2	36	J J Pull	CW Counterweights	\$211	
SWSLAT Worksurface Supporting	3		B Bar Pull	DL Digital Lock	\$450	
	4					
	5					
SLAT	3	36	J	CW		

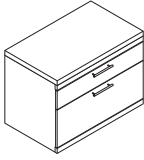

BF				PAINT			LAMINATE FRONT (UPCHARGE)		
H	W	D	MODEL #	P1	P2	P3	L1	L2	L3
22 3/8"	30"	18 1/4"	SLAT130(J/B)	\$1,272	\$1,399	\$1,526	+ \$441	+ \$612	+ \$782
22 3/8"	36"	18 1/4"	SLAT136(J/B)	\$1,399	\$1,538	\$1,678	+ \$441	+ \$624	+ \$807
22 3/8"	42"	18 1/4"	SLAT142(J/B)	\$1,525	\$1,677	\$1,830	+ \$441	+ \$637	+ \$832

Counterweights are required for all lateral files that are not ganged together or otherwise anchored.

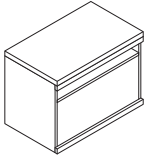

BF Shelf				PAINT			LAMINATE FRONT (UPCHARGE)		
H	W	D	MODEL #	P1	P2	P3	L1	L2	L3
22 3/8"	30"	18 1/4"	SLATS130	\$1,019	\$1,120	\$1,222	N/A	N/A	N/A
22 3/8"	36"	18 1/4"	SLATS136	\$1,146	\$1,260	\$1,375	N/A	N/A	N/A
22 3/8"	42"	18 1/4"	SLATS142	\$1,272	\$1,399	\$1,526	N/A	N/A	N/A

Counterweights are required for all lateral files that are not ganged together or otherwise anchored.

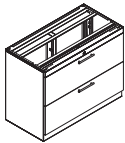

Worksurface Supporting				PAINT			LAMINATE FRONT (UPCHARGE)		
H	W	D	MODEL #	P1	P2	P3	L1	L2	L3
27 3/4"	30"	18 1/4"	SWSLAT230(J/B)	\$1,133	\$1,246	\$1,359	+ \$505	+ \$555	+ \$666
27 3/4"	36"	18 1/4"	SWSLAT236(J/B)	\$1,259	\$1,384	\$1,510	+ \$556	+ \$611	+ \$733
27 3/4"	42"	18 1/4"	SWSLAT242(J/B)	\$1,385	\$1,523	\$1,662	+ \$606	+ \$666	+ \$799

Counterweights are required for all lateral files that are not ganged together or otherwise anchored.

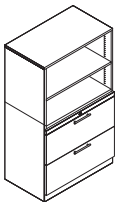

2 Drawer/2 Open Shelves				PAINT			LAMINATE FRONT (UPCHARGE)		
H	W	D	MODEL #	P1	P2	P3	L1	L2	L3
51 3/8"	30"	18 1/4"	SLAT2S2F30(J/B)	\$2,789	\$3,067	\$3,346	+ \$2,527	+ \$2,779	+ \$3,032
52 3/8"	36"	18 1/4"	SLAT2S2F36(J/B)	\$3,168	\$3,484	\$3,801	+ \$2,527	+ \$2,779	+ \$3,032
53 3/8"	42"	18 1/4"	SLAT2S2F42(J/B)	\$3,736	\$4,109	\$4,483	+ \$2,527	+ \$2,779	+ \$3,032

Counterweights are included.

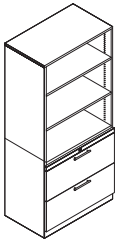

2 Drawer/3 Open Shelves				PAINT			LAMINATE FRONT (UPCHARGE)		
H	W	D	MODEL #	P1	P2	P3	L1	L2	L3
65 3/8"	30"	18 1/4"	SLAT3S2F30(J/B)	\$2,915	\$3,206	\$3,498	+ \$2,527	+ \$2,779	+ \$3,032
65 3/8"	36"	18 1/4"	SLAT3S2F36(J/B)	\$3,294	\$3,623	\$3,952	+ \$2,527	+ \$2,779	+ \$3,032
65 3/8"	42"	18 1/4"	SLAT3S2F42(J/B)	\$3,862	\$4,248	\$4,634	+ \$2,527	+ \$2,779	+ \$3,032

Counterweights are included.

Lateral – Accessories

DESCRIPTION	MODEL #	BLACK ONLY
Lateral Ganging Kit	SLATGK	\$185

Specify

1. Model #
2. Case finish
3. Front finish
Laminate not available on J pull

Lateral			W	Pull	Options	
SLAT1	BF Lateral w/Metal Top	36	J J Pull B Bar Pull	CW Counterweights \$211	DL Digital Lock \$450	
SLAT1		36	J	CW		

Laterals



6B Drawer

H	W	D	MODEL #	PAINT		
				P1	P2	P3
39 7/8"	30"	18 1/4"	S6BLAT30(J/B)	\$2,371	\$2,608	\$2,845
39 7/8"	36"	18 1/4"	S6BLAT36(J/B)	\$2,498	\$2,747	\$2,997
39 7/8"	42"	18 1/4"	S6BLAT42(J/B)	\$2,725	\$2,997	\$3,270

Counterweights are required for all lateral files that are not ganged together or otherwise anchored.

6B Drawer, No Top

39 7/8"	30"	18 1/4"	S6BLAT30NT(J/B)	\$2,283	\$2,511	\$2,739
39 7/8"	36"	18 1/4"	S6BLAT36NT(J/B)	\$2,410	\$2,651	\$2,892
39 7/8"	42"	18 1/4"	S6BLAT42NT(J/B)	\$2,662	\$2,928	\$3,194

Counterweights are required for all lateral files that are not ganged together or otherwise anchored.

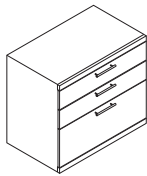

BBF Drawer

28 3/8"	30"	18 1/4"	S2BFLAT30(J/B)	\$1,525	\$1,677	\$1,830
28 3/8"	36"	18 1/4"	S2BFLAT36(J/B)	\$1,651	\$1,816	\$1,981
28 3/8"	42"	18 1/4"	S2BFLAT42(J/B)	\$1,778	\$1,955	\$2,133

Counterweights are required for all lateral files that are not ganged together or otherwise anchored.

BBF Drawer, No Top

28 3/8"	30"	18 1/4"	S2BFLAT30NT(J/B)	\$1,525	\$1,677	\$1,830
28 3/8"	36"	18 1/4"	S2BFLAT36NT(J/B)	\$1,651	\$1,816	\$1,981
28 3/8"	42"	18 1/4"	S2BFLAT42NT(J/B)	\$1,778	\$1,955	\$2,133

Counterweights are required for all lateral files that are not ganged together or otherwise anchored.



BBFF Drawer

39 7/8"	30"	18 1/4"	S2B2FLAT30(J/B)	\$2,030	\$2,233	\$2,436
39 7/8"	36"	18 1/4"	S2B2FLAT36(J/B)	\$2,157	\$2,372	\$2,588
39 7/8"	42"	18 1/4"	S2B2FLAT42(J/B)	\$2,283	\$2,511	\$2,739

Counterweights are required for all lateral files that are not ganged together or otherwise anchored.

BBFF Drawer, No Top

39 7/8"	30"	18 1/4"	S2B2FLAT30NT(J/B)	\$2,030	\$2,233	\$2,436
39 7/8"	36"	18 1/4"	S2B2FLAT36NT(J/B)	\$2,157	\$2,372	\$2,588
39 7/8"	42"	18 1/4"	S2B2FLAT42NT(J/B)	\$2,283	\$2,511	\$2,739

Counterweights are required for all lateral files that are not ganged together or otherwise anchored.

Specify

1. Model #
2. Case finish

Lateral			W	Pull	Options		
S6BLAT	6B Drawer Lat		36	J J Pull	CW Counterweights		\$211
S2BFLAT	BBF Drawer Lat			B Bar Pull	DL Digital Lock		\$450
S2B2FLAT	BBFF Drawer Lat						
S6BLAT			36	J	CW		

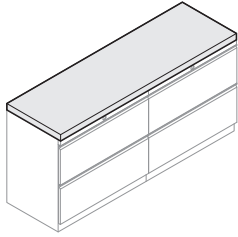

Common Top – 18" Deep

H	W	D	MODEL #	LAMINATE		
				L1	L2	L3
5/8"	30"	18 1/4"	LT30	\$441	\$485	\$529
5/8"	36"	18 1/4"	LT36	\$480	\$528	\$576
5/8"	42"	18 1/4"	LT42	\$492	\$541	\$590
5/8"	60"	18 1/4"	LT60	\$517	\$568	\$620
5/8"	66"	18 1/4"	LT66	\$586	\$644	\$703
5/8"	72"	18 1/4"	LT72	\$612	\$673	\$734
5/8"	84"	18 1/4"	LT84	\$618	\$679	\$741
5/8"	90"	18 1/4"	LT90	\$625	\$687	\$750
5/8"	108"	18 1/4"	LT108	\$669	\$735	\$802
5/8"	126"	18 1/4"	LT126	\$890	\$979	\$1,068

Common Top – 36" Deep

5/8"	30"	36 1/2"	LT3037	\$631	\$694	\$757
5/8"	36"	36 1/2"	LT3637	\$694	\$763	\$832
5/8"	42"	36 1/2"	LT4237	\$789	\$867	\$946
5/8"	60"	36 1/2"	LT6037	\$915	\$1,006	\$1,098
5/8"	66"	36 1/2"	LT6637	\$1,011	\$1,112	\$1,213
5/8"	72"	36 1/2"	LT7237	\$1,073	\$1,180	\$1,287
5/8"	84"	36 1/2"	LT8437	\$1,137	\$1,250	\$1,364
5/8"	90"	36 1/2"	LT9037	\$1,200	\$1,320	\$1,440
5/8"	108"	36 1/2"	LT10837	\$1,452	\$1,597	\$1,742
5/8"	126"	36 1/2"	LT12637	\$1,579	\$1,736	\$1,894

Specify Lateral Common Top

1. Model #
2. Laminate
3. Edge band

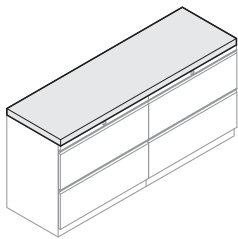

Cushion – 18" Deep

H	W	D	MODEL #	FABRIC							
				A/1	B/2	C/3	D/4	E/5	F/6	G/7	H/8
1"	30"	18 1/4"	LC30	\$413	\$513	\$563	\$613	\$663	\$713	\$763	\$833
1"	36"	18 1/4"	LC36	\$443	\$543	\$598	\$648	\$708	\$773	\$838	\$928
1"	42"	18 1/4"	LC42	\$475	\$575	\$635	\$685	\$755	\$835	\$915	\$1,025
1"	60"	18 1/4"	LC60	\$551	\$651	\$721	\$781	\$871	\$971	\$1,071	\$1,221
1"	66"	18 1/4"	LC66	\$583	\$683	\$758	\$818	\$923	\$1,033	\$1,148	\$1,308
1"	72"	18 1/4"	LC72	\$615	\$715	\$795	\$855	\$975	\$1,095	\$1,225	\$1,395
1"	84"	18 1/4"	LC84	\$665	\$765	\$855	\$925	\$1,065	\$1,205	\$1,375	\$1,525
1"	90"	18 1/4"	LC90	\$703	\$803	\$893	\$963	\$1,123	\$1,273	\$1,463	\$1,613
1"	108"	18 1/4"	LC108	\$779	\$879	\$979	\$1,059	\$1,239	\$1,414	\$1,609	\$1,789
1"	126"	18 1/4"	LC126	\$855	\$955	\$1,065	\$1,155	\$1,355	\$1,555	\$1,755	\$1,965

Cushion – 36" Deep

1"	30"	36 1/2"	LC3037	\$602	\$662	\$722	\$822	\$922	\$1,022	\$1,122	\$1,222
1"	36"	36 1/2"	LC3637	\$640	\$710	\$775	\$890	\$1,005	\$1,125	\$1,245	\$1,390
1"	42"	36 1/2"	LC4237	\$678	\$758	\$828	\$958	\$1,088	\$1,228	\$1,368	\$1,558
1"	60"	36 1/2"	LC6037	\$767	\$867	\$957	\$1,097	\$1,267	\$1,457	\$1,657	\$1,967
1"	66"	36 1/2"	LC6637	\$804	\$904	\$1,004	\$1,154	\$1,344	\$1,549	\$1,774	\$2,114
1"	72"	36 1/2"	LC7237	\$842	\$942	\$1,052	\$1,212	\$1,422	\$1,642	\$1,892	\$2,262
1"	84"	36 1/2"	LC8437	\$918	\$1,018	\$1,148	\$1,318	\$1,558	\$1,808	\$2,088	\$2,488
1"	90"	36 1/2"	LC9037	\$956	\$1,056	\$1,196	\$1,376	\$1,636	\$1,916	\$2,216	\$2,636
1"	108"	36 1/2"	LC10837	\$1,057	\$1,162	\$1,317	\$1,507	\$1,787	\$2,127	\$2,477	\$2,937
1"	126"	36 1/2"	LC12637	\$1,158	\$1,268	\$1,438	\$1,638	\$1,938	\$2,338	\$2,738	\$3,238

Specify Lateral Cushion

1. Model #
2. Fabric

Towers

General Info

Step 1 – Model

	H	W	Drawers	Coat Door	Pull
STWR Tower	56	22	FF BBF	L Left R Right	J J Pull B Bar Pull R Radiused Pull
STWR	56	22	FF	L	B

Step 2 – Case Finish

Paint
301 Champagne
301

Step 3 – Front Finish

Not Available w/J Pull	
Laminate	
PW-STK	Studio Teak
PW-STK	

FEATURES

LOCK

- Lock core is removable.
- 24" Side access tower includes 2 locks. All others include 1 lock.
- Keyed alike available upon request.
- Master and change key available upon request. See (page 9).
- Individual locking drawers available upon request. Upcharge may apply.

DRAWERS

- Include full suspension steel ball-bearing slides.
- Drawer fronts include rubber bumpers for quiet operation.
- Slides include anti-rebound and quick disconnect features.
- File drawer dividers which allow side-to-side filing are sold separately.

SHELVES

- Shelves are adjustable in 1 ½" increments.

LEVELING GLIDES – TOWER

- Leveling glides allow for 7/8" adjustment.

LEVELING GLIDES – SIDE ACCESS TOWER

- Leveling glides allow for 1 5/8" adjustment.

DOORS

- Cupboard and coat doors include concealed hinges that allow for 110° degree opening.

CONSTRUCTION

OUTER SHELL & DRAWER CONSTRUCTION

Welded steel frame construction & formed channels ensure strength in key areas.

Inner top channel	18 Gauge
Bottom channel	18 Gauge
Side channels	18 Gauge
Outer top	21 Gauge
Outer back	21 Gauge
Outer sides	21 Gauge
Outer center	21 Gauge
Drawer & door fronts	21 Gauge
Shelves	18 Gauge
Drawer bins	22 Gauge
Drawer fronts	20 Gauge

DRAWER LOAD CAPACITY

6" Box drawers	50 lbs
12" File drawers	70 lbs

SHELF LOAD CAPACITY

Shelf	61 lbs
-------	--------

DRAWER INNER DIMENSIONS

Height

Box drawer	4 ½"
File drawer	9 ½"

Width

All drawers	12 ½"
-------------	-------

Depth

All drawers	18 ¼"
-------------	-------

PULL STYLES

Available with Laminate Front

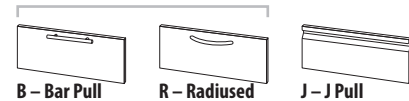

SURFACE MATERIALS

CASE

Paint

FRONTS

w/Bar Pull (B)	Paint or Laminate
w/Radiused Pull (R)	Paint or Laminate
w/J Pull (J)	Paint

NOTE: Laminate is not available on 24" side access towers, 15" towers or 15" side access towers.

DRAWER PULL

Bar (B)	Satin nickel
Radiused (R)	Satin nickel
J (J)	Paint

LOCK

Satin nickel

TOWERS

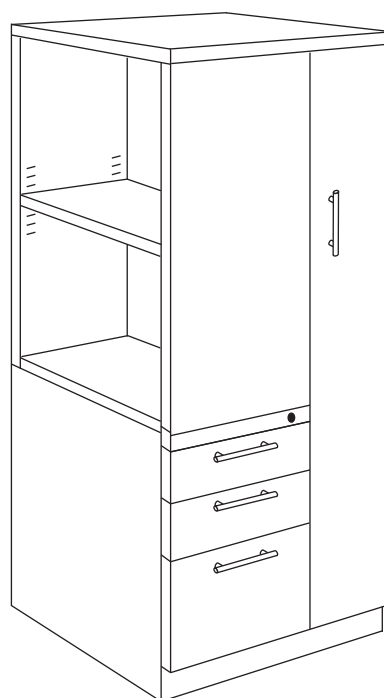

Storage

Towers

24" Wide



STWR5624BBFLB

40" High — does not include an adj. shelf

COAT DOOR	H	W	D	MODEL #	PAINT			LAMINATE FRONT (UPCHARGE)		
					P1	P2	P3	L1	L2	L3
L	39 7/8"	23 1/2"	23 1/2"	STWR4024FFL(J/B/R)	\$2,460	\$2,706	\$2,952	+ \$1,137	+ \$1,250	+ \$1,364
R	39 7/8"	23 1/2"	23 1/2"	STWR4024FFR(J/B/R)	\$2,460	\$2,706	\$2,952	+ \$1,137	+ \$1,250	+ \$1,364
L	39 7/8"	23 1/2"	23 1/2"	STWR4024BBFL(J/B/R)	\$2,523	\$2,775	\$3,027	+ \$1,174	+ \$1,291	+ \$1,408
R	39 7/8"	23 1/2"	23 1/2"	STWR4024BBFR(J/B/R)	\$2,523	\$2,775	\$3,027	+ \$1,174	+ \$1,291	+ \$1,408

46" High — does not include an adj. shelf

L	46"	23 1/2"	23 1/2"	STWR4624FFL(J/B/R)	\$2,649	\$2,913	\$3,178	+ \$1,162	+ \$1,278	+ \$1,394
R	46"	23 1/2"	23 1/2"	STWR4624FFR(J/B/R)	\$2,649	\$2,913	\$3,178	+ \$1,162	+ \$1,278	+ \$1,394
L	46"	23 1/2"	23 1/2"	STWR4624BBFL(J/B/R)	\$2,713	\$2,984	\$3,255	+ \$1,200	+ \$1,320	+ \$1,440
R	46"	23 1/2"	23 1/2"	STWR4624BBFR(J/B/R)	\$2,713	\$2,984	\$3,255	+ \$1,200	+ \$1,320	+ \$1,440

51" High — includes 1 adj. shelf

L	51 3/8"	23 1/2"	23 1/2"	STWR5124FFL(J/B/R)	\$2,713	\$2,984	\$3,255	+ \$1,200	+ \$1,320	+ \$1,440
R	51 3/8"	23 1/2"	23 1/2"	STWR5124FFR(J/B/R)	\$2,713	\$2,984	\$3,255	+ \$1,200	+ \$1,320	+ \$1,440
L	51 3/8"	23 1/2"	23 1/2"	STWR5124BBFL(J/B/R)	\$2,776	\$3,053	\$3,331	+ \$1,225	+ \$1,347	+ \$1,470
R	51 3/8"	23 1/2"	23 1/2"	STWR5124BBFR(J/B/R)	\$2,776	\$3,053	\$3,331	+ \$1,225	+ \$1,347	+ \$1,470

56" High — includes 1 adj. shelf

L	56"	23 1/2"	23 1/2"	STWR5624FFL(J/B/R)	\$2,776	\$3,053	\$3,331	+ \$1,225	+ \$1,347	+ \$1,470
R	56"	23 1/2"	23 1/2"	STWR5624FFR(J/B/R)	\$2,776	\$3,053	\$3,331	+ \$1,225	+ \$1,347	+ \$1,470
L	56"	23 1/2"	23 1/2"	STWR5624BBFL(J/B/R)	\$2,902	\$3,192	\$3,482	+ \$1,263	+ \$1,389	+ \$1,515
R	56"	23 1/2"	23 1/2"	STWR5624BBFR(J/B/R)	\$2,902	\$3,192	\$3,482	+ \$1,263	+ \$1,389	+ \$1,515

66" High — includes 2 adj. shelves

L	65 7/8"	23 1/2"	23 1/2"	STWR6624FFL(J/B/R)	\$3,028	\$3,330	\$3,633	+ \$1,516	+ \$1,667	+ \$1,819
R	65 7/8"	23 1/2"	23 1/2"	STWR6624FFR(J/B/R)	\$3,028	\$3,330	\$3,633	+ \$1,516	+ \$1,667	+ \$1,819
L	65 7/8"	23 1/2"	23 1/2"	STWR6624BBFL(J/B/R)	\$3,092	\$3,401	\$3,710	+ \$1,643	+ \$1,807	+ \$1,971
R	65 7/8"	23 1/2"	23 1/2"	STWR6624BBFR(J/B/R)	\$3,092	\$3,401	\$3,710	+ \$1,643	+ \$1,807	+ \$1,971

								Options		
		H	W	Drawers	Coat Door	Pull		DL	Digital Lock	\$450
STWR	Tower	56	22	FF BBF	L Left R Right	J B Bar Pull R Radiused Pull				
STWR		56	22	FF	L	J		DL		

Specify

- Model #
- Case finish
- Front finish
Laminate not available on J pull

Pulls



B – Bar Pull



J – J Pull



R – Radiused

Application Notes

- Single lock for all doors & drawers
- Coat closet includes side-to-side coat rod
- Leveling glides allow for 7/8" adjustment



SSAT5624BBFRB



Available Laminate Locations

46" High — does not include an adj. shelf

COAT DOOR	H	W	D	MODEL #	PAINT			LAMINATE FRONT (UPCHARGE)		
					P1	P2	P3	L1	L2	L3
L	46"	23 1/2"	23 1/2"	SSAT4624FFL(J/B/R)	\$2,624	\$2,886	\$3,148	+\$1,137	+\$1,250	+\$1,364
R	46"	23 1/2"	23 1/2"	SSAT4624FFR(J/B/R)	\$2,624	\$2,886	\$3,148	+\$1,137	+\$1,250	+\$1,364
L	46"	23 1/2"	23 1/2"	SSAT4624BBFL(J/B/R)	\$2,688	\$2,956	\$3,225	+\$1,174	+\$1,291	+\$1,408
R	46"	23 1/2"	23 1/2"	SSAT4624BBFR(J/B/R)	\$2,688	\$2,956	\$3,225	+\$1,174	+\$1,291	+\$1,408

51" High — includes 1 adj. shelf

L	51 3/8"	23 1/2"	23 1/2"	SSAT5124FFL(J/B/R)	\$2,713	\$2,984	\$3,255	+\$1,200	+\$1,320	+\$1,440
R	51 3/8"	23 1/2"	23 1/2"	SSAT5124FFR(J/B/R)	\$2,713	\$2,984	\$3,255	+\$1,200	+\$1,320	+\$1,440
L	51 3/8"	23 1/2"	23 1/2"	SSAT5124BBFL(J/B/R)	\$2,776	\$3,053	\$3,331	+\$1,225	+\$1,347	+\$1,470
R	51 3/8"	23 1/2"	23 1/2"	SSAT5124BBFR(J/B/R)	\$2,776	\$3,053	\$3,331	+\$1,225	+\$1,347	+\$1,470

56" High — includes 1 adj. shelf

L	56"	23 1/2"	23 1/2"	SSAT5624FFL(J/B/R)	\$2,814	\$3,095	\$3,376	+\$1,225	+\$1,347	+\$1,470
R	56"	23 1/2"	23 1/2"	SSAT5624FFR(J/B/R)	\$2,814	\$3,095	\$3,376	+\$1,225	+\$1,347	+\$1,470
L	56"	23 1/2"	23 1/2"	SSAT5624BBFL(J/B/R)	\$2,940	\$3,234	\$3,528	+\$1,263	+\$1,389	+\$1,515
R	56"	23 1/2"	23 1/2"	SSAT5624BBFR(J/B/R)	\$2,940	\$3,234	\$3,528	+\$1,263	+\$1,389	+\$1,515

66" High — includes 2 adj. shelves

L	65 7/8"	23 1/2"	23 1/2"	SSAT6524FFL(J/B/R)	\$2,966	\$3,262	\$3,559	+\$1,516	+\$1,667	+\$1,819
R	65 7/8"	23 1/2"	23 1/2"	SSAT6524FFR(J/B/R)	\$2,966	\$3,262	\$3,559	+\$1,516	+\$1,667	+\$1,819
L	65 7/8"	23 1/2"	23 1/2"	SSAT6524BBFL(J/B/R)	\$3,028	\$3,330	\$3,633	+\$1,643	+\$1,807	+\$1,971
R	65 7/8"	23 1/2"	23 1/2"	SSAT6524BBFR(J/B/R)	\$3,028	\$3,330	\$3,633	+\$1,643	+\$1,807	+\$1,971



Worksurface Supporting Bracket — factory installed

BLACK ONLY

Add at the end of tower model number

SWSSB

\$121

							Options			
SSAT	Side Access Tower	H	W	Drawers	Coat Door	Pull				
		56	22	FF BBF	L Left R Right	J J Pull B Bar Pull R Radiused Pull	SWSSB	DL	Digital Lock	\$121 \$450
SSAT		56	22	FF	L	J	SWSSB			

Specify

1. Model #
2. Case finish

Pulls



B – Bar Pull



J – J Pull



R – Radiused

Application Notes

- Includes 2 locks, keyed alike
- Coat closet includes two-pronged coat hook
- Leveling glides allow for 1/8" adjustment

Worksurface Supporting Bracket

Must be ordered with a Side Access Tower. Factory installed.

Towers

15" Wide



STWR5615FFLB

46" High — does not include an adj. shelf

HINGE	H	W	D	MODEL #	PAINT		
					P1	P2	P3
L	46"	15 1/4"	23 1/2"	STWR4615FFL(J/B/R)	\$1,702	\$1,872	\$2,042
R	46"	15 1/4"	23 1/2"	STWR4615FFR(J/B/R)	\$1,702	\$1,872	\$2,042
L	46"	15 1/4"	23 1/2"	STWR4615BBFL(J/B/R)	\$1,866	\$2,052	\$2,239
R	46"	15 1/4"	23 1/2"	STWR4615BBFR(J/B/R)	\$1,866	\$2,052	\$2,239

51" High — includes 1 adj. shelf

L	51 3/8"	15 1/4"	23 1/2"	STWR5115FFL(J/B/R)	\$1,866	\$2,052	\$2,239
R	51 3/8"	15 1/4"	23 1/2"	STWR5115FFR(J/B/R)	\$1,866	\$2,052	\$2,239
L	51 3/8"	15 1/4"	23 1/2"	STWR5115BBFL(J/B/R)	\$1,955	\$2,150	\$2,346
R	51 3/8"	15 1/4"	23 1/2"	STWR5115BBFR(J/B/R)	\$1,955	\$2,150	\$2,346

56" High — includes 1 adj. shelf

L	56"	15 1/4"	23 1/2"	STWR5615FFL(J/B/R)	\$1,955	\$2,150	\$2,346
R	56"	15 1/4"	23 1/2"	STWR5615FFR(J/B/R)	\$1,955	\$2,150	\$2,346
L	56"	15 1/4"	23 1/2"	STWR5615BBFL(J/B/R)	\$2,017	\$2,218	\$2,420
R	56"	15 1/4"	23 1/2"	STWR5615BBFR(J/B/R)	\$2,017	\$2,218	\$2,420

66" High — includes 2 adj. shelves

L	65 7/8"	15 1/4"	23 1/2"	STWR6615FFL(J/B/R)	\$2,017	\$2,218	\$2,420
R	65 7/8"	15 1/4"	23 1/2"	STWR6615FFR(J/B/R)	\$2,017	\$2,218	\$2,420
L	65 7/8"	15 1/4"	23 1/2"	STWR6615BBFL(J/B/R)	\$2,144	\$2,358	\$2,572
R	65 7/8"	15 1/4"	23 1/2"	STWR6615BBFR(J/B/R)	\$2,144	\$2,358	\$2,572

								Options		
STWR	Tower	H	W	Drawers	Coat Door	Pull		DL	Digital Lock	\$450
		56	15	FF BBF	L Left R Right	J B Bar Pull R Radiused Pull				
STWR		56	15	FF	L	J		DL		

Specify

1. Model #
2. Case finish

Pulls



B – Bar Pull



R – Radiused



J – J Pull

Application Notes

- Single lock for cupboard & drawers
- Leveling glides allow for 7/8" adjustment
- Will not accommodate worksurface support bracket



SSAT5615BBFLB

46" High — does not include an adj. shelf

OPEN	H	W	D	MODEL #	PAINT		
					P1	P2	P3
L	46"	15 1/4"	23 1/2"	SSAT4615FFL(J/B/R)	\$1,638	\$1,801	\$1,965
R	46"	15 1/4"	23 1/2"	SSAT4615FFR(J/B/R)	\$1,638	\$1,801	\$1,965
L	46"	15 1/4"	23 1/2"	SSAT4615BBFL(J/B/R)	\$1,764	\$1,940	\$2,116
R	46"	15 1/4"	23 1/2"	SSAT4615BBFR(J/B/R)	\$1,764	\$1,940	\$2,116

51" High — includes 1 adj. shelf

L	51 3/8"	15 1/4"	23 1/2"	SSAT5115FFL(J/B/R)	\$1,764	\$1,940	\$2,116
R	51 3/8"	15 1/4"	23 1/2"	SSAT5115FFR(J/B/R)	\$1,764	\$1,940	\$2,116
L	51 3/8"	15 1/4"	23 1/2"	SSAT5115BBFL(J/B/R)	\$1,891	\$2,080	\$2,269
R	51 3/8"	15 1/4"	23 1/2"	SSAT5115BBFR(J/B/R)	\$1,891	\$2,080	\$2,269

56" High — includes 1 adj. shelf

L	56"	15 1/4"	23 1/2"	SSAT5615FFL(J/B/R)	\$1,891	\$2,080	\$2,269
R	56"	15 1/4"	23 1/2"	SSAT5615FFR(J/B/R)	\$1,891	\$2,080	\$2,269
L	56"	15 1/4"	23 1/2"	SSAT5615BBFL(J/B/R)	\$2,017	\$2,218	\$2,420
R	56"	15 1/4"	23 1/2"	SSAT5615BBFR(J/B/R)	\$2,017	\$2,218	\$2,420

66" High — includes 2 adj. shelves

L	65 7/8"	15 1/4"	23 1/2"	SSAT6515FFL(J/B/R)	\$1,955	\$2,150	\$2,346
R	65 7/8"	15 1/4"	23 1/2"	SSAT6515FFR(J/B/R)	\$1,955	\$2,150	\$2,346
L	65 7/8"	15 1/4"	23 1/2"	SSAT6515BBFL(J/B/R)	\$2,081	\$2,289	\$2,497
R	65 7/8"	15 1/4"	23 1/2"	SSAT6515BBFR(J/B/R)	\$2,081	\$2,289	\$2,497

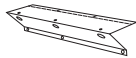

Worksurface Supporting Bracket — factory installed

BLACK ONLY

Add at the end of tower model number

SWSSB

\$121

WORKSURFACES & 15" SIDE ACCESS TOWERS

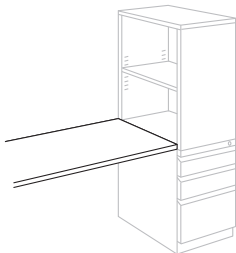

When adding a 15" tower to the end of a worksurface you will need to add a "T" to the end of the model number in order to make the worksurface and tower completely flush. This will only be necessary on 24" deep worksurfaces with a width from 48" – 84".

							Options			
SSAT	Side Access Tower	H	W	Drawers	Coat Door	Pull				
SSAT		56	15	FF BBF	L Left R Right	J J Pull B Bar Pull R Radiused Pull	SWSSB			\$121
							DL	Digital Lock		\$450
SSAT		56	15	FF	L	J	SWSSB			

Specify

1. Model #
2. Case finish

Pulls

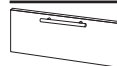

B – Bar Pull



J – J Pull



R – Radiused

Application Notes

- Single lock for all drawers
- Leveling glides allow for 1 5/8" adjustment

Worksurface Supporting Bracket

Must be ordered with a Side Access Tower. Factory installed.

Credenzas

General Info

Step 1 – Model

SCR	Credenza	Drawer Width		Shelf Width		Top		Pull	
		30	D Drawer	20	S Shelf	MT NT	Metal Top No Top	J B	J Pull Bar Pull
SCR		30	D	20	S	MT		B	

Step 2 – Case Finish

Paint
301 Champagne
301

Step 3 – Front Finish

Not Available w/J Pull	
Laminate	
PW-STK	Studio Teak
PW-STK	

FEATURES

COUNTERWEIGHT

- Two drawer cabinets include factory installed counterweights
- Low storage cabinets that do not include shelves do not need counterweight

LOCK

- Available on credenza products which feature drawers
- Lock core is removable
- Keyed alike available upon request
- Master and change key available upon request. See (page 9).

DRAWERS

- Include full suspension steel ball-bearing slides
- Drawer fronts include rubber bumpers for quiet operation

SHELF

- ¾" High adjustable shelf

LEVELING GLIDES

- 4 Leveling glides allow for ½" adjustment

TOP

- Available in metal, cushion and laminate

CONSTRUCTION

OUTER SHELL & DRAWER CONSTRUCTION

Welded steel frame construction & formed channels ensure strength in key areas.

Bottom channels	16 Gauge
Top channels	18 Gauge
Shelves	18 Gauge
Side channels	20 Gauge
Side panels	20 Gauge
Top	20 Gauge
Fronts	20 Gauge
Drawer bins	22 Gauge

DRAWER INNER DIMENSIONS

Height

6" Drawer	4 ½"
12" Drawer	10 ¾"

Width

30" Wide drawer	26 ¼"
36" Wide drawer	32 ¼"
42" Wide drawer	38 ¼"

Depth

All drawers	15 ⅞"
-------------	-------

SHELF INNER DIMENSIONS

Height

All shelves	16 ⅝"
-------------	-------

Width

30" Wide drawer	28 ½"
36" Wide drawer	34 ½"
42" Wide drawer	40 ½"

Depth

All drawers	19"
-------------	-----

PULL STYLES

Available with Laminate Front



B – Bar Pull



J – J Pull

SURFACE MATERIALS

CASE

Paint

FRONTS

w/Bar pull (B)	Paint or Laminate
w/J pull (J)	Paint

DRAWER PULL

Bar (B)	Satin nickel
J (J)	Paint

LOCK

Satin nickel

CUSHION TOP

Upholstery

CREDENZAS

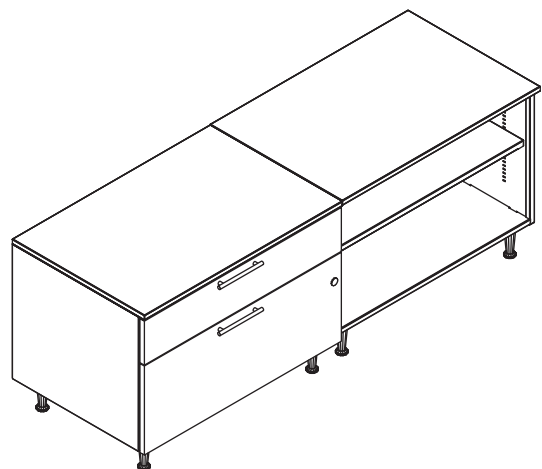

Storage

Credenzas

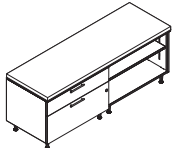

Credenzas

DESCRIPTION	H	W	D	MODEL #	PAINT			LAMINATE FRONT (UPCHARGE)		
					P1	P2	P3	L1	L2	L3
30" Drawers, 30" open shelf	22 1/4"	60"	20"	SCR30D30S(J/B)	\$3,516	\$3,867	\$4,219	+\$669	+\$735	+\$802
30" Drawers, 36" open shelf	22 1/4"	66"	20"	SCR30D36S(J/B)	\$3,624	\$3,986	\$4,348	+\$669	+\$735	+\$802
36" Drawers, 36" open shelf	22 1/4"	72"	20"	SCR36D36S(J/B)	\$3,700	\$4,070	\$4,440	+\$694	+\$763	+\$832



Credenza – Drawers

30" Drawers, metal top	22 1/4"	30"	20"	SCRD3020MT(J/B)	\$1,449	\$1,593	\$1,738	+\$669	+\$735	+\$802
36" Drawers, metal top	22 1/4"	36"	20"	SCRD3620MT(J/B)	\$1,512	\$1,663	\$1,814	+\$694	+\$763	+\$832
42" Drawers, metal top	22 1/4"	42"	20"	SCRD4220MT(J/B)	\$1,638	\$1,801	\$1,965	+\$745	+\$819	+\$894



Credenza – Shelves — includes 1 adj. shelf

30" Shelf, metal top	22 1/4"	30"	20"	SCR3020MT	\$1,158	\$1,273	\$1,389	N/A	N/A	N/A
36" Shelf, metal top	22 1/4"	36"	20"	SCR3620MT	\$1,234	\$1,357	\$1,480	N/A	N/A	N/A
42" Shelf, metal top	22 1/4"	42"	20"	SCR3620MT	\$1,335	\$1,468	\$1,602	N/A	N/A	N/A

Credenza – Accessories

Floating top supports, 2 legs	5 1/2"	2 1/2"	1 1/8"	SCRSL2	\$312	\$343	\$374	N/A	N/A	N/A
Credenza center leg support				SCRCLS	\$248	N/A	N/A	N/A	N/A	N/A
Credenza ganging kit				SCRGK	\$185	N/A	N/A	N/A	N/A	N/A

										Options				
		Drawer Width		Shelf Width		Top		Pull						
SCR	Credenza	30	D	Drawer	20	S	Shelf	MT	Metal Top	J	J Pull	DL	Digital Lock	\$450
										B	Bar Pull			
SCR		30	D		20	S		MT		J		DL		

Specify

1. Model #
2. Case finish
3. Front finish
Laminate not available on J pull

Credenza Includes

- 2 low storage cabinets
- 1 laminate top & ganging kit
- 1 credenza center support leg

Pulls

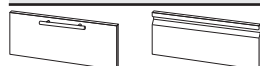

B – Bar Pull

J – J Pull

Application Notes

- Credenzas must be assembled in the field
- When ganging 2 units together, order ganging kit
- Leveling glides allow for 1 5/8" adjustment

- Drawer units include 1 – 6" drawer & 1 – 12" file drawer & counterweight

Center Leg

- Helps to gang 2 credenza pieces together side by side
- Eliminate the 4 legs in the center and replace with this single support leg

Ganging Kit

- Ganging kit for use when specifying laminate top separately, does not include center leg

Floating Top Supports

- Floating top supports may not be used on a metal top, includes top mounting bracket, screws & drill plate

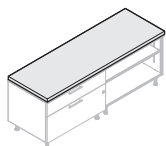

Credenza – Common Tops

DESCRIPTION	H	W	D	MODEL #	LAMINATE		
					L1	L2	L3
Single 30" W credenza top	5/8"	30"	20"	CT30	\$460	\$506	\$552
Single 36" W credenza top	5/8"	36"	20"	CT36	\$492	\$541	\$590
Single 42" W credenza top	5/8"	42"	20"	CT42	\$530	\$583	\$636
Double 30" W credenza top	5/8"	60"	20"	CT60	\$600	\$660	\$720
Double 30"/36" W credenza top	5/8"	66"	20"	CT66	\$631	\$694	\$757
Double 36" W credenza top OR 30"/42" W credenza top	5/8"	72"	20"	CT72	\$644	\$708	\$772
Double 36"/42" W credenza top	5/8"	78"	20"	CT78	\$669	\$735	\$802
Double 42" W credenza top	5/8"	84"	20"	CT84	\$707	\$777	\$848
Triple 30" W credenza top	5/8"	90"	20"	CT90	\$745	\$819	\$894

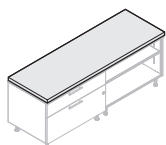

Credenza Cushion Tops

H	W	D	MODEL #	FABRIC							
				A/1	B/2	C/3	D/4	E/5	F/6	G/7	H/8
1"	12"	20"	SCRC2012	\$261	\$486	\$561	\$661	\$761	\$861	\$1,186	\$1,361
1"	18"	20"	SCRC2018	\$312	\$537	\$612	\$712	\$812	\$912	\$1,237	\$1,412
1"	30"	20"	SCRC2030	\$413	\$638	\$713	\$813	\$913	\$1,013	\$1,338	\$1,513
1"	36"	20"	SCRC2036	\$501	\$726	\$801	\$901	\$1,001	\$1,101	\$1,426	\$1,601
1"	42"	20"	SCRC2042	\$551	\$776	\$851	\$951	\$1,051	\$1,151	\$1,476	\$1,651
1"	60"	20"	SCRC2060	\$665	\$890	\$965	\$1,065	\$1,165	\$1,265	\$1,590	\$1,765
1"	66"	20"	SCRC2066	\$716	\$941	\$1,016	\$1,116	\$1,216	\$1,316	\$1,641	\$1,816
1"	72"	20"	SCRC2072	\$753	\$978	\$1,053	\$1,153	\$1,253	\$1,353	\$1,678	\$1,853

Specify

1. Model #
2. Case finish
3. Front finish
Laminate not available on J pull

Pulls

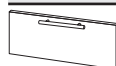

B – Bar Pull



J – J Pull

Application Notes

Center Leg

- Helps to gang 2 credenza pieces together side by side

Ganging Kit

- When ganging 2 units together, order ganging kit, does not include center leg

Floating Top Supports

- Floating top supports may not be used on a metal top, includes top mounting bracket, screws & drill plate

Cabinets

Step 1 – Model

SCAB	Cabinet	H	W	D	Pull
SCAB	Cabinet	77	30	18	J B J Pull Bar Pull
SCAB		77	30	18	J

Step 2 – Case Finish

Paint
301 Champagne
301

FEATURES

LOCK

- Lock core is removable.
- Keyed alike available upon request.
- Master and change key available upon request. See (page 9).

DOORS

- Concealed hinges allow for 110° degrees opening.

LEVELING GLIDES

- 4 Leveling glides allow for ¼" adjustment.

CONSTRUCTION

OUTER SHELL & DRAWER CONSTRUCTION

Welded steel frame construction & formed channels ensure strength in key areas.

Back panel	20 – 22 Gauge
Side panels	20 – 22 Gauge
Inner channels	18 Gauge
Top	18 Gauge
Doors	18 Gauge

SHELF LOAD CAPACITY

Shelf	140 lbs
-------	---------

TOP LOAD CAPACITY

30" Wide cabinets	140 lbs
36" Wide cabinets	169 lbs
42" Wide cabinets	197 lbs

INNER DIMENSIONS

Height

2 High	23 ½"
3 High	35"
4 High	46 ½"
5 High	61"
6 High	72 ½"

Width

30" Wide cabinet	26 ¾"
36" Wide cabinet	32 ¾"
42" Wide cabinet	38 ¾"

Depth

18" Deep	17 ¾"
24" Deep	22 ¾"

PULL STYLES



B – Bar Pull



J – J Pull

SURFACE MATERIALS

CASE

Paint

FRONTS

w/Bar Pull (B)	Paint
w/J Pull (J)	Paint

DRAWER PULL

Bar (B)	Satin nickel
J (J)	Paint

LOCK

Satin nickel

CABINETS

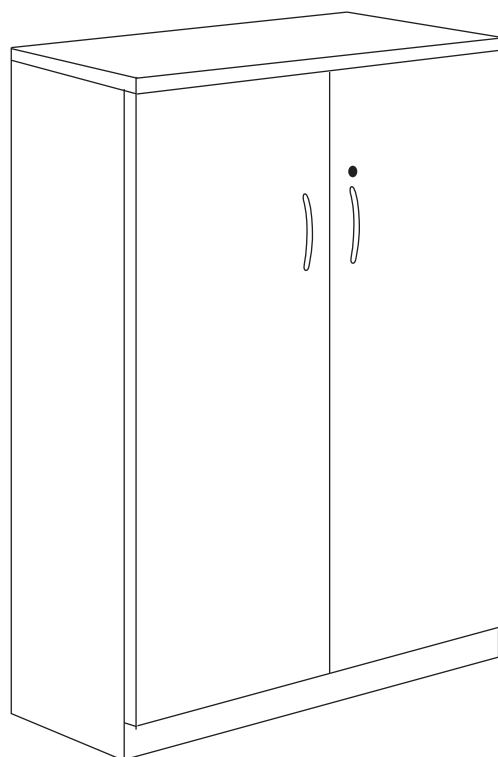

Storage

Cabinets

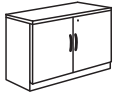

2 High

H	W	D	MODEL #	PAINT		
				P1	P2	P3
28 3/8"	30"	18 1/4"	SCAB293018(J/B)	\$1,259	\$1,384	\$1,510
28 3/8"	36"	18 1/4"	SCAB293618(J/B)	\$1,385	\$1,523	\$1,662
28 3/8"	42"	18 1/4"	SCAB294218(J/B)	\$1,512	\$1,663	\$1,814



3 High

39 7/8"	30"	18 1/4"	SCAB403018(J/B)	\$1,512	\$1,663	\$1,814
39 7/8"	36"	18 1/4"	SCAB403618(J/B)	\$1,638	\$1,801	\$1,965
39 7/8"	42"	18 1/4"	SCAB404218(J/B)	\$1,764	\$1,940	\$2,116



4 High

51 3/8"	30"	18 1/4"	SCAB523018(J/B)	\$1,828	\$2,010	\$2,193
51 3/8"	36"	18 1/4"	SCAB523618(J/B)	\$1,955	\$2,150	\$2,346
51 3/8"	42"	18 1/4"	SCAB524218(J/B)	\$2,081	\$2,289	\$2,497

Specify

1. Model #
2. Case finish

Application Notes

- Leveling glides allow for 1/4" adjustment

		H	W	D	Pull		Options	
SCAB	Cabinet	77	30	18	J B	J Pull Bar Pull	DL	Digital Lock \$450
SCAB		77	30	18	J		DL	



5 High

H	W	D	MODEL #	PAINT		
				P1	P2	P3
65 7/8"	30"	18 1/4"	SCAB663018(J/B)	\$2,081	\$2,289	\$2,497
65 7/8"	36"	18 1/4"	SCAB663618(J/B)	\$2,207	\$2,427	\$2,648
65 7/8"	36"	23 1/2"	SCAB663624(J/B)	\$2,713	\$2,984	\$3,255
65 7/8"	42"	18 1/4"	SCAB664218(J/B)	\$2,334	\$2,567	\$2,800



6 High

77 3/8"	30"	18 1/4"	SCAB773018(J/B)	\$2,396	\$2,635	\$2,875
77 3/8"	36"	18 1/4"	SCAB773618(J/B)	\$2,523	\$2,775	\$3,027
77 3/8"	36"	23 1/2"	SCAB773624(J/B)	\$2,839	\$3,122	\$3,406
77 3/8"	42"	18 1/4"	SCAB774218(J/B)	\$2,649	\$2,913	\$3,178

Specify

1. Model #
2. Case finish

Application Notes

- Leveling glides allow for 1/4" adjustment

		H	W	D	Pull		Options		
SCAB	Cabinet	77	30	18	J	J Pull B Bar Pull	DL	Digital Lock	\$450
SCAB		77	30	18	J		DL		

Lockers

Step 1 – Model

		H	D	Hinge	Pull
SLKR	Locker	51	18	L R	J B J Pull Bar Pull
SLKR		51	18	L	J

Step 2 – Case Finish

Paint
301 Champagne
301

FEATURES

LOCK

- Lock core is removable.
- Keyed alike available upon request.
- Master and change key available upon request. See (page 9).
- Digital lock available upon request.
- Keyless available upon request.

BODY

- Available in 2 depths: 18 ¼" and 23 ½".

DOORS

- All lockers come standard with metal doors.
- Concealed hinges allow for 100 degree opening.

SHELF

- Includes one fixed shelf on top w/ 12" clear height above.
- Additional shelves may be ordered separately.

COAT ROD

- Includes side-to-side coat rod beneath shelf.

LEVELING GLIDES

- 4 leveling glides allow for 7/8" adjustment.
- Glides are accessible from the inside of the locker.

CONSTRUCTION

OUTER SHELL & DRAWER CONSTRUCTION

Welded steel frame construction & formed channels ensure strength in key areas.

Top panel	21 Gauge
Side panels	21 Gauge
Back panel	21 Gauge
Center panel	21 Gauge
Inner top channel	18 Gauge
Inner bottom channel	18 Gauge
Inner side channels	18 Gauge
Bottom panel	16 Gauge
Door fronts	20 – 22 Gauge
Shelves	18 Gauge

DRAWER INNER DIMENSIONS

Height

Above shelf	12"
Below coat rod – 51" High	31 7/10"
Below coat rod – 66" High	46 1/5"

Width

All lockers	9 4/5"
-------------	--------

Depth

18 ½" Deep locker	17 3/5"
23 ½" Deep locker	22 3/5"

PULL STYLES



B – Bar Pull



J – J Pull

SURFACE MATERIALS

LOCKER

Paint

DRAWER PULL

Bar (B)

J (J)

Satin nickel

Paint

LOCK

Satin nickel

LOCKERS

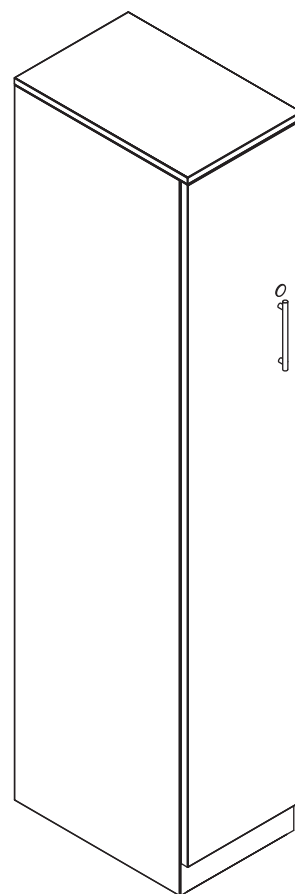

Storage

Lockers

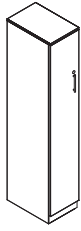

Single — 51" High

TYPE	HINGE	H	W	D	MODEL #	PAINT		
						P1	P2	P3
1 Door	L	51 3/8"	12"	18"	SLKR5118L(J/B)	\$1,764	\$1,940	\$2,116
1 Door	R	51 3/8"	12"	18"	SLKR5118R(J/B)	\$1,764	\$1,940	\$2,116
1 Door	L	51 3/8"	12"	24"	SLKR5124L(J/B)	\$1,803	\$1,983	\$2,163
1 Door	R	51 3/8"	12"	24"	SLKR5124R(J/B)	\$1,803	\$1,983	\$2,163

Single — 66" High

1 Door	L	65 7/8"	12"	18"	SLKR6618L(J/B)	\$1,866	\$2,053	\$2,239
1 Door	R	65 7/8"	12"	18"	SLKR6618R(J/B)	\$1,866	\$2,053	\$2,239
1 Door	L	65 7/8"	12"	24"	SLKR6624L(J/B)	\$1,930	\$2,123	\$2,316
1 Door	R	65 7/8"	12"	24"	SLKR6624R(J/B)	\$1,930	\$2,123	\$2,316

Double

2 Door	L	65 7/8"	12"	18"	SLKR2D6612L(J/B)	\$2,030	\$2,233	\$2,436
2 Door	R	65 7/8"	12"	18"	SLKR2D6612R(J/B)	\$2,030	\$2,233	\$2,436
2 Door	L	65 7/8"	18"	18"	SLKR2D6618L(J/B)	\$2,157	\$2,372	\$2,588
2 Door	R	65 7/8"	18"	18"	SLKR2D6618R(J/B)	\$2,157	\$2,372	\$2,588

Quad

4 Door	L	65 7/8"	24"	18"	SLKR4D6624L(J/B)	\$3,421	\$3,763	\$4,105
4 Door	R	65 7/8"	24"	18"	SLKR4D6624R(J/B)	\$3,421	\$3,763	\$4,105

Cubby

4 Door	L	34 3/4"	24"	18"	SLKR4D3524L(J/B)	\$2,410	\$2,651	\$2,892
4 Door	R	34 3/4"	24"	18"	SLKR4D3524R(J/B)	\$2,410	\$2,651	\$2,892
8 Door	L	65 7/8"	24"	18"	SLKR8D6624L(J/B)	\$4,179	\$4,596	\$5,014
8 Door	R	65 7/8"	24"	18"	SLKR8D6624R(J/B)	\$4,179	\$4,596	\$5,014

Shelves

Qty 2		12"		SLKRS122	\$324	\$356	\$388
Qty 2		18"		SLKRS182	\$374	\$411	\$448
Qty 4		24"		SLKRS244	\$450	\$495	\$540

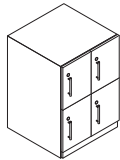
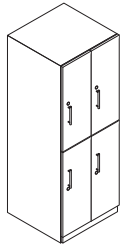
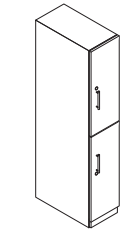

Specify

1. Model #
2. Case finish

Application Notes

- Includes 1 fixed shelf on top with 12" clear height above
- Leveling glides allow for 7/8" adjustment

18" Deep

- Include (2) two-pronged coat hooks

24" Deep

- Include (1) side-to-side coat rod

		H	D	Hinge	Pull	Options
SLKR	Locker	51	18	L R	J B Bar Pull	DL Digital Lock \$450
SLKR		51	18	L	J	DL

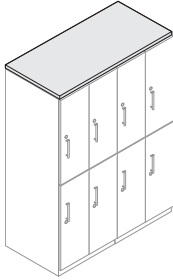

Locker Common Top – 18" Deep

H	W	D	MODEL #	LAMINATE		
				L1	L2	L3
5/8"	24"	18"	LKRT2418	\$404	\$444	\$484
5/8"	36"	18"	LKRT3618	\$480	\$528	\$576
5/8"	42"	18"	LKRT4218	\$493	\$542	\$591
5/8"	48"	18"	LKRT4818	\$502	\$552	\$602
5/8"	54"	18"	LKRT5418	\$511	\$562	\$613
5/8"	60"	18"	LKRT6018	\$518	\$569	\$621
5/8"	72"	18"	LKRT7218	\$613	\$674	\$735
5/8"	84"	18"	LKRT8418	\$619	\$680	\$742
5/8"	90"	18"	LKRT9018	\$625	\$687	\$750
5/8"	96"	18"	LKRT9618	\$647	\$711	\$776
5/8"	108"	18"	LKRT10818	\$670	\$737	\$804

Specify

1. Model #
2. Laminate finish

SLKR	Locker Common Top	W	D
		48	18
SLKRT		66	18

Bookcases

Step 1 – Model

	H	W
SBC Bookcase	66	42
SBC	66	42

Step 2 – Case Finish

Paint
301 Champagne
301

FEATURES

SHELVES

- 1" thick.
- Adjustable in ½" increments.
- 2-high bookcases will accommodate binder-height storage on both shelves.
- All other bookcases, binder-height storage is available on all but 1 shelf.

LEVELING GLIDES

- 4 Leveling glides allow for 1 ⅝" adjustment.

SAFETY:

- To ensure stability, do not install a 4, 5 or 6 high bookcase in the center of a room.
- Bookcases should be installed back-to-back or against a wall.

NOTE

- 2 high bookcases are slightly shorter than 2-high lateral files and double door storage cabinets.
- 2 high bookcases are designed to fit under a worksurface.

CONSTRUCTION

OUTER SHELL & DRAWER CONSTRUCTION

Welded steel frame construction & formed channels ensure strength in key areas.

Side channels	22 Gauge
Side panels	22 Gauge
Bottom panel	18 Gauge
Shelves	18 Gauge

SHELF LOAD CAPACITY

All bookcases	140 lbs
---------------	---------

INNER DIMENSIONS

Height

2 High	25 ⅛"
3 High	37 ¾"
4 High	48 ½"
5 High	63 ¾"
6 High	74 ⅝"

Width

30" Wide bookcase	27 ⅞"
36" Wide bookcase	33 ⅞"
42" Wide bookcase	39 ⅞"

Depth

All cabinets	13 ⅞"
--------------	-------

SURFACE MATERIALS

CASE

Paint

TOP

Paint

BOOKCASES

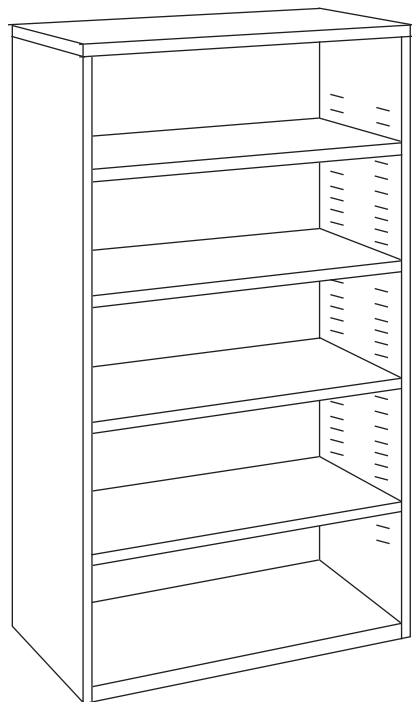

Storage

Bookcases



2 High

H	W	D	MODEL #	PAINT		
				P1	P2	P3
27 ¾"	30"	13 ⅜"	SBC2830	\$1,045	\$1,149	\$1,254
27 ¾"	36"	13 ⅜"	SBC2836	\$1,107	\$1,217	\$1,328
27 ¾"	42"	13 ⅜"	SBC2842	\$1,234	\$1,357	\$1,480



3 High

39 ⅞"	30"	13 ⅜"	SBC4030	\$1,133	\$1,246	\$1,359
39 ⅞"	36"	13 ⅜"	SBC4036	\$1,234	\$1,357	\$1,480
39 ⅞"	42"	13 ⅜"	SBC4042	\$1,360	\$1,496	\$1,632



4 High

51 ⅜"	30"	13 ⅜"	SBC5230	\$1,259	\$1,384	\$1,510
51 ⅜"	36"	13 ⅜"	SBC5236	\$1,360	\$1,496	\$1,632
51 ⅜"	42"	13 ⅜"	SBC5242	\$1,486	\$1,634	\$1,783

Specify

1. Model #
2. Case finish

Application Notes

- Steel frame construction
- Double wall construction on side panels
- Leveling glides allow for ⅝" adjustment
- Shelves adjust in ½" increments
- Bookcases should be installed with back against a wall
- Shelf capacity 140 lbs
- 2 high bookcase is slightly shorter than 2 door cabinet as it is designed to fit under a worksurface

		H	W
SBC	Bookcase	66	42
SBC		66	42



5 High

H	W	D	MODEL #	PAINT		
				P1	P2	P3
65 7/8"	30"	13 3/8"	SBC6630	\$1,385	\$1,523	\$1,662
65 7/8"	36"	13 3/8"	SBC6636	\$1,486	\$1,634	\$1,783
65 7/8"	42"	13 3/8"	SBC6642	\$1,613	\$1,774	\$1,935

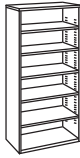

6 High

77 3/8"	30"	13 3/8"	SBC7730	\$1,512	\$1,663	\$1,814
77 3/8"	36"	13 3/8"	SBC7736	\$1,613	\$1,774	\$1,935
77 3/8"	42"	13 3/8"	SBC7742	\$1,739	\$1,912	\$2,086

Specify

1. Model #
2. Case finish

Application Notes

- Steel frame construction
- Double wall construction on side panels
- Leveling glides allow for 5/8" adjustment
- Shelves adjust in 1/2" increments
- Bookcases should be installed with back against a wall.
- Shelf capacity 140 lbs
- 2 high bookcase is slightly shorter than 2 door cabinet as it is designed to fit under a worksurface

		H	W
SBC	Bookcase	66	42
SBC		66	42

WORKPLACE ACCESSORIES

Neutral Posture is proud to offer the complete package for commercial office furniture. Workplace accessories round out our offering and allow users to truly customize their space to be as comfortable and as ergonomic as possible.

CUSTOMIZE YOUR SPACE WITH:

- Keyboard mechanisms
- Keyboard trays
- Monitor arms
- Footrests
- Tablet holders
- CPU holders
- Forearm supports
- Patented ergonomic products

WORKPLACE ACCESSORIES

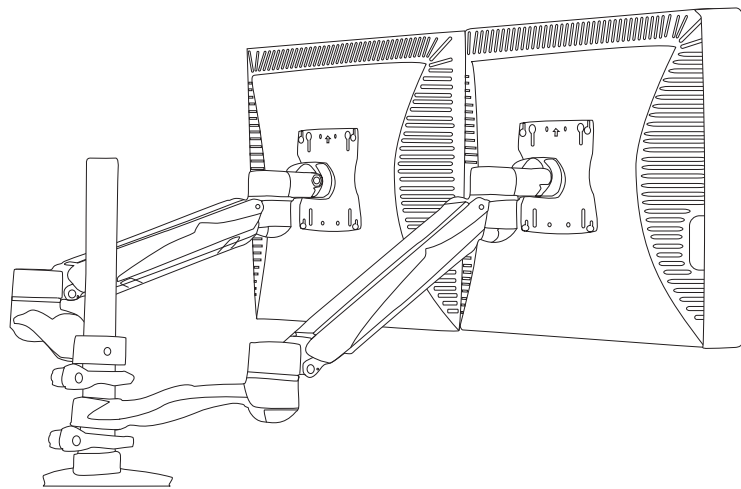

Use Seating/Workplace Accessories Discount

Keyboard Trays & Arms

KEYBOARD ARMS



Leverless

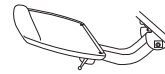

Sit/Stand

	A	C
Code	A	C
Leverless Height	✓	✓
Height	-6" – 2.5"	-6" – 8"
Tilt	-15° – 0°	-15° – 0°
Spring Assist	✓	✓
360° Rear Swivel	✓	✓
Track Length	23"	21"
(OPTIONAL) Short Track	18"	18"
Glide Track	✓	✓
Quick Ship	QS	QS
List	\$231	\$253

KEYBOARD TRAYS

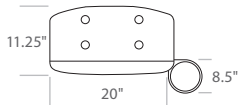

11

- Straights, corners & natural keyboards
- Anti-skid neoprene pads hold keyboard securely in place

List \$170

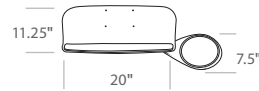

86 — ELEMENTAL®

- Straights, corners and natural keyboards
- Made from 100% recycled aluminum
- Polished surface

List \$324

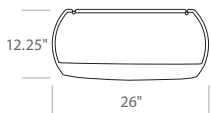



43 — SOFTOUCH™

- Straight
- Urethane over steel plate
- Includes mouse surface

List \$253

Use Seating/Workplace Accessories Discount

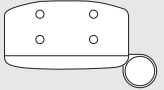
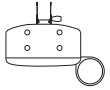
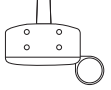
EASY COMBOS

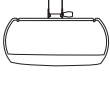
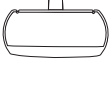
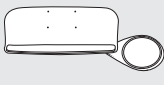
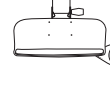
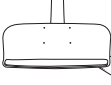
		Keyboard Arms	
		Leverless (A)	Sit/Stand (C)
Keyboard Trays	 11	 Easy A11 \$401	 Easy C11 \$423
	 43 – SofTouch™	 Easy A43 \$484	 Easy C43 \$506
	 86 – elementAI®	 Easy A86 \$555	 Easy C86 \$577

General

5 **Short Track – 18"** \$0
Only available on (A) or (C) arm

Monitor Arms

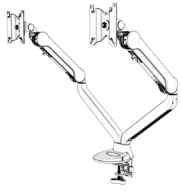

MONITOR ARMS

GLOBAL MONITOR ARM

- Full motion: Place your monitor wherever you like with tilt, swivel, and rotate movement.
- Multi-screen setups: Effortless adjustment for different monitor position that meets your need.
- Cable management: Enjoy an organized desktop.
- Premium gas spring: Raise your monitor at an ergonomic height with a high-quality gas lift to save up more valuable space.
- Ergonomic benefits: Boost efficiency at work and reduce the pressure on your neck, back, and eye strain.

SPECIFICATIONS

Material	Aluminum, steel and plastic
Weight Capacity	2~9 kg (4.4~19.8 lbs) / each arm
Lift	Max. 508mm(20"), Min. 225mm(8.86")
Tilt	-35° to +90°
Rotation	±128°
Swivel	360°
Extension	Max. 1163.8mm(45.82")
Mounting Option	Clamp
Fits Desk Thickness	10~65mm (0.4"~2.55")
VESA	75/100mm

MODEL #		LIST
MAMS2M2NBLK	Black	\$632
MAMS2M2NSLVR	Silver	\$690

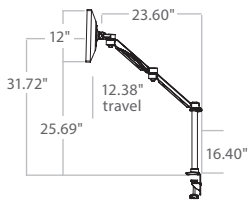

SIT/STAND

- Sturdy aluminum construction with vesa compatibility
- Width & depth adjustable fasteners
- Convenient pull handle

Model #	Description	List
KCG-SSB	Black	\$632
KCG-SSS	Silver	\$632

SIT/STAND



STANDUP®

- Retrofits between most existing keyboard trays & keyboard arms
- Mounts directly to worksurface without keyboard arm
- Additional 2" – 11" of height adjustment
- Infinite range positioning
- \$50 discount when ordered with any Easy Combo

MODEL #	LIST
SUP04	\$462

Use Seating/Workplace Accessories Discount

ACCESSORIES

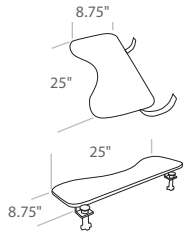

FOREARM SUPPORTS

- Alleviates shoulder, neck & body burden
- Promotes good posture & ergonomic sitting
- Reduces pressure on ulnar nerve
- Reduces upper body fatigue
- Lightweight & portable



Model 1	Model 2	
160241 \$264	160243 \$264	w/Hooks
160242 \$264	160244 \$264	w/Screws

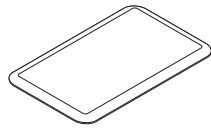

ANTI-FATIGUE FLOOR MATS

- Premium comfort will not bottom out or lose bounce over time
- Commercial-grade heavy-duty polyurethane
- Matte texture provides optimum traction
- Beveled edge reduces tripping potential
- Available in black

H	W	D	MODEL #	LIST
¾"	32"	20"	EAM3220B	\$313
¾"	48"	20"	EAM4820B	\$478
¾"	72"	20"	EAM7220B	\$712
¾"	36"	24"	EAM3624B	\$396
¾"	60"	36"	EAM6036B	\$910

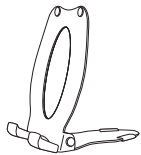

TABLET HOLDER

- Light weight & portable
- Dimensions: 6.76 x 5.5 x 2
- Holds tablets, phones or documents upright
- Easily adjusts for comfortable viewing angle
- Rests on desktop or flat surfaces
- Available in black only

Model #	List
TABHLDR	\$150

CPU HOLDERS

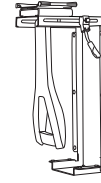

CPU HOLDER

- 360 swivel
- Black powder coat
- Fits CPU's
- 3.75" – 8.25" wide
- 12.25" – 20.5" tall
- 17 ¾" track
- Steel

Model #
VCPU

List
\$214

ACCESSORIES

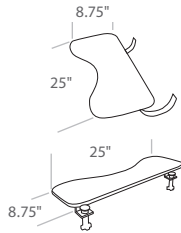

FOREARM SUPPORTS

- Alleviates shoulder, neck & body burden
- Promotes good posture & ergonomic sitting
- Reduces pressure on ulnar nerve
- Reduces upper body fatigue
- Lightweight & portable



Model 1	Model 2	
160241 \$264	160243 \$264	w/Hooks
160242 \$264	160244 \$264	w/Screws

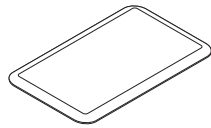

ANTI-FATIGUE FLOOR MATS

- Premium comfort will not bottom out or lose bounce over time
- Commercial-grade heavy-duty polyurethane
- Matte texture provides optimum traction
- Beveled edge reduces tripping potential
- Available in black

H	W	D	MODEL #	LIST
¾"	32"	20"	EAM3220B	\$313
¾"	48"	20"	EAM4820B	\$478
¾"	72"	20"	EAM7220B	\$712
¾"	36"	24"	EAM3624B	\$396
¾"	60"	36"	EAM6036B	\$910

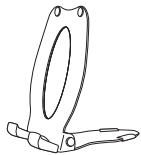

TABLET HOLDER

- Light weight & portable
- Dimensions: 6.76 x 5.5 x 2
- Holds tablets, phones or documents upright
- Easily adjusts for comfortable viewing angle
- Rests on desktop or flat surfaces
- Available in black only

Model #	List
TABHLDR	\$150

CPU HOLDERS

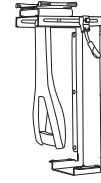

CPU HOLDER

- 360 swivel
- Black powder coat
- Fits CPU's
- 3.75" – 8.25" wide
- 12.25" – 20.5" tall
- 17 ¾" track
- Steel

Model #
VCPU

List
\$214

ACCESSORIES

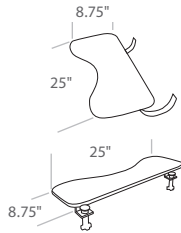

FOREARM SUPPORTS

- Alleviates shoulder, neck & body burden
- Promotes good posture & ergonomic sitting
- Reduces pressure on ulnar nerve
- Reduces upper body fatigue
- Lightweight & portable



Model 1	Model 2	
160241 \$264	160243 \$264	w/Hooks
160242 \$264	160244 \$264	w/Screws

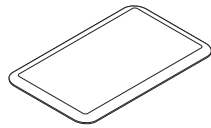

ANTI-FATIGUE FLOOR MATS

- Premium comfort will not bottom out or lose bounce over time
- Commercial-grade heavy-duty polyurethane
- Matte texture provides optimum traction
- Beveled edge reduces tripping potential
- Available in black

H	W	D	MODEL #	LIST
¾"	32"	20"	EAM3220B	\$313
¾"	48"	20"	EAM4820B	\$478
¾"	72"	20"	EAM7220B	\$712
¾"	36"	24"	EAM3624B	\$396
¾"	60"	36"	EAM6036B	\$910

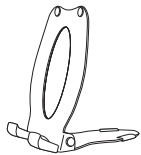

TABLET HOLDER

- Light weight & portable
- Dimensions: 6.76 x 5.5 x 2
- Holds tablets, phones or documents upright
- Easily adjusts for comfortable viewing angle
- Rests on desktop or flat surfaces
- Available in black only

Model #	List
TABHLDR	\$150

CPU HOLDERS

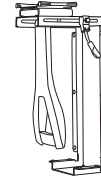

CPU HOLDER

- 360 swivel
- Black powder coat
- Fits CPU's
- 3.75" – 8.25" wide
- 12.25" – 20.5" tall
- 17 ¾" track
- Steel

Model #
VCPU

List
\$214

Graded In Fabrics

GRADED-IN AND COM UPHOLSTERY

Neutral Posture's furniture is manufactured to the highest standards. Our artisans are skilled in creating consistent finishes across all products and materials. However, the unique nature of upholstery and the other materials that are used in production means that no two pieces of furniture will be exactly alike. Fabrics will upholster differently based on composition and construction. Neutral Posture makes every effort to ensure that each item is produced to our exacting standards, but cannot be held responsible for slight variations in upholstery, color and general appearance.

Similarly, the images in our publications are as accurate as your monitor is calibrated. Customers are reminded that colors and finishes may vary according to the unique nature of each item of furniture.

Neutral Posture will not be responsible for variances in the acoustical performance of a panel due to the fact that certain fabrics perform differently from others. Additionally, Neutral Posture cannot guarantee that the graded-in fabrics will be Indoor Air Quality and/or BIFMA Level compliant. Please see the fabric manufacturer's website for these details and cleaning instructions specific to selected fabric.

For specific color matching requirements please contact Customer Servicet.

Please note: The finish codes used by Neutral Posture are used as a guide to the appearance of the furniture and should not be used to determine the specific materials used in the construction of an item of furniture.

The Neutral Posture Upholstery Department is pleased to offer a Graded-in program and also accepts COM for most products. For certain items or in cases of unusual or difficult fabric patterns additional material may be required. Any unusual or special cutting requirements must be requested in writing and a full-width fabric repeat sent to the Customer Service in order for a quotation to be provided. The customer is responsible for shipping COM to Customer Service.

CARNEGIE		
Manufacturer	Pattern	Grade
Carnegie	Abacus Embroider	H
Carnegie	Arrow X	G
Carnegie	Bardot	F
Carnegie	Buff	E
Carnegie	Cane Embroider X	Call
Carnegie	Channel	E
Carnegie	Chelsea	E
Carnegie	Cirque Couture	Call
Carnegie	Covet	D
Carnegie	Crossing	F
Carnegie	Dazzle	H
Carnegie	Departure	E
Carnegie	Edge	F
Carnegie	Elite	C
Carnegie	Groove	E
Carnegie	Hashtag	E
Carnegie	Haze X	G
Carnegie	Hepburn	F
Carnegie	Hide	E
Carnegie	Impress	E
Carnegie	Index	D
Carnegie	Keystone	E
Carnegie	Kid	E
Carnegie	Merge	F
Carnegie	Monode Embroider	I
Carnegie	Ola	Call
Carnegie	Reverie	E
Carnegie	Rise	C
Carnegie	Roxy	E
Carnegie	Tangle	F
Carnegie	Theory	E
Carnegie	Touch	C
Carnegie	Trace X	G
Carnegie	Twine	F
Carnegie	Verse	D

C.F. STINSON		
Manufacturer	Pattern	Grade
C. F. Stinson	Aerie	D
C. F. Stinson	Ally	C
C. F. Stinson	Aperture	C
C. F. Stinson	Array	D
C. F. Stinson	Axis Too!	C
C. F. Stinson	Backdrop	C
C. F. Stinson	Binary	E
C. F. Stinson	Code	C
C. F. Stinson	Dapple	D
C. F. Stinson	Del Mar	D
C. F. Stinson	Focus	C
C. F. Stinson	Galaxy	E
C. F. Stinson	Genesis	C
C. F. Stinson	Imprint	C
C. F. Stinson	Intermix	C
C. F. Stinson	Linea	E
C. F. Stinson	Lulu	C
C. F. Stinson	Luther II	D
C. F. Stinson	Mason	C
C. F. Stinson	Mira	C
C. F. Stinson	Nikko	D
C. F. Stinson	Prime	B
C. F. Stinson	Repetition	D
C. F. Stinson	Ringer	C
C. F. Stinson	Sight Line	D
C. F. Stinson	Spree	C
C. F. Stinson	Surf	C
C. F. Stinson	Tally	E
C. F. Stinson	Tussah	D
C. F. Stinson	Venture	C

DESIGNTEX

Manufacturer	Pattern	Grade
Designtex	Appleseed	F
Designtex	Arne	E
Designtex	Birdseye	D
Designtex	Brushed Flannel	E
Designtex	Cloud Velvet	E
Designtex	Crossweave	E
Designtex	Ellipsis	D
Designtex	Everywhere Texture	E
Designtex	Gamut	D
Designtex	Gridley	E
Designtex	"Hem Stitch	"
Designtex	Melange	E
Designtex	Minnie	D
Designtex	Otto	F
Designtex	"Reppweave	"
Designtex	Rocket	E
Designtex	Singing In The Rain	E
Designtex	Ulster	C
Designtex	Wend	E
Designtex	Woolish	E

GUILFORD OF MAINE

Manufacturer	Pattern	Grade
Guilford of Maine	Amaze	B
Guilford of Maine	Anchorage	B
Guilford of Maine	Auster	B
Guilford of Maine	Axiom	B
Guilford of Maine	Bailey	B
Guilford of Maine	Beacon (54" bolt)	B
Guilford of Maine	BeeHave (54" bolt)	B
Guilford of Maine	Birdseye	B
Guilford of Maine	Block Party	C
Guilford of Maine	Broadcast	B
Guilford of Maine	Cape Cod	B
Guilford of Maine	Chase	B
Guilford of Maine	Couture (54" bolt)	B
Guilford of Maine	Crossings	B
Guilford of Maine	Crosstown	B
Guilford of Maine	Dashing	B
Guilford of Maine	Drift	C
Guilford of Maine	Essence	B
Guilford of Maine	Felt (64" bolt)	C
Guilford of Maine	FR701®	C
Guilford of Maine	FR702®	C
Guilford of Maine	Framework	B
Guilford of Maine	Galaxy	C
Guilford of Maine	Groove	C
Guilford of Maine	Hatchet	B
Guilford of Maine	Highbeams (54" bolt)	B
Guilford of Maine	Intermix	B
Guilford of Maine	Intuition (54" bolt)	C
Guilford of Maine	Jane (54" bolt)	B
Guilford of Maine	Lido	B
Guilford of Maine	Meander	B
Guilford of Maine	Metallation	B
Guilford of Maine	Metro	B
Guilford of Maine	Mingle	B
Guilford of Maine	Network	C
Guilford of Maine	Open House (54" bolt)	A
Guilford of Maine	Otto	B
Guilford of Maine	Palette (54" bolt)	C
Guilford of Maine	Paradise	B
Guilford of Maine	Parameter	B
Guilford of Maine	Phone Tag	C
Guilford of Maine	Pursuit	B
Guilford of Maine	Quadrille (54" bolt)	B
Guilford of Maine	Rattan	C
Guilford of Maine	Reeds	B
Guilford of Maine	Sand	C
Guilford of Maine	Spinel	B
Guilford of Maine	Sprite	B
Guilford of Maine	Steadfast	B
Guilford of Maine	Strata	B
Guilford of Maine	Streetwise	C
Guilford of Maine	Studio 54	C
Guilford of Maine	Synopsis (54" bolt)	B
Guilford of Maine	Tempest	C
Guilford of Maine	Theory	B
Guilford of Maine	Tweed	B
Guilford of Maine	Twigs	B
Guilford of Maine	Vertical Surface Blends	C
Guilford of Maine	Vertical Surface Solids	C

Manufacturer	Pattern	Grade
Guilford of Maine	Vortex	B
Guilford of Maine	Whisper	B

LUNA

Manufacturer	Pattern	Grade
Luna	Affinity	G
Luna	Aspect	G
Luna	Facet	G
Luna	Idyll	E
Luna	Incandescent	E
Luna	Intersect	E
Luna	Luminescent	E
Luna	Radar	E
Luna	Signal	E
Luna	Stitch	E
Luna	Transmission	E
Luna	Twiggy	H
Luna	Twist	E

Graded In Fabrics

MAHARAM			MAYER			MOMENTUM		
Manufacturer	Pattern	Grade	Manufacturer	Pattern	Grade	Manufacturer	Pattern	Grade
Maharam	Crisp	E	Mayer	Basic	B	Momentum	Cameo	E
Maharam	Field	E	Mayer	Blueprint	A	Momentum	Curtain Call	E
Maharam	Flock	E	Mayer	Cipher	A	Momentum	Encore	D
Maharam	Giance	E	Mayer	Code	A	Momentum	Glint	E
Maharam	Glint	E	Mayer	Continuum 10	B	Momentum	Kinect	E
Maharam	Hum	E	Mayer	Copa	C	Momentum	Meander	E
Maharam	Morse	E	Mayer	Cross Check	B	Momentum	Pact	E
Maharam	Parallel	E	Mayer	Echo	E	Momentum	Proverb	E
Maharam	Reply	E	Mayer	Equal	B	Momentum	Script	E
Maharam	Sharkskin 2	F	Mayer	Flair	3	Momentum	Tenor	E
Maharam	Sketch	E	Mayer	Forte	A	Momentum	Universe	E
Maharam	Spiral	E	Mayer	Foundation 10	B	Momentum	Aloft	F
Maharam	Unit	E	Mayer	Fresco	B	Momentum	Aurora PC	E
			Mayer	Graph	A	Momentum	Barcode	E
			Mayer	Gridline	C	Momentum	Bevy	F
			Mayer	Interlude	C	Momentum	Branches	E
			Mayer	Luminary	B	Momentum	Charette	E
			Mayer	Melange	C	Momentum	Dogwood Leaves	F
			Mayer	Multi Crepe	C	Momentum	Elon	E
			Mayer	Nexus	C	Momentum	Essence PC	F
			Mayer	Optic	B	Momentum	Gradient Grid	E
			Mayer	Paragon	C	Momentum	Gradual	F
			Mayer	Pebble Beach	C	Momentum	Haiku	F
			Mayer	Prism	B	Momentum	Line Dance	E
			Mayer	Quattro	B	Momentum	Midlands	F
			Mayer	Reverb	C	Momentum	Mood	F
			Mayer	Spectre	C	Momentum	Respite	E
			Mayer	Strata	B	Momentum	Rosetta	E
			Mayer	Terrain	C	Momentum	Serendipity II	F
			Mayer	Whirlwind	C	Momentum	Solaris	F
			Mayer	Zest	B	Momentum	Streamers	F
						Momentum	Vinea	F
						Momentum	Waypoint	E
						Momentum	Zento	F

LEGACY TABLE OF CONTENTS

LEGACY FINISHES 188

Laminate	188
Edge Band	188
Paint	189
Plexiglass	189
Fabric	189

GEN 1 & 2 PANELS 190

Fabric Panels	190
Fabric Panels	191
Insert Panels	192
Insert Panels	193
Wall Starter & Wall Mount Chanel	194

POST ASSEMBLIES 195

Straight	195
Corner (90°)	195
End	195
3-way (T)	196
3-way (Y)	196
4-way (X)	196
Dual Height Posts	197
Triple Height Posts	198
Single Height Posts	199
Panel Connectors	200
Shrouds	201

GEN 3 202

Fabric Panels	202
Insert Panels	203

POST ASSEMBLIES 204

Straight	204
2-way (L)	204
2-way (120)	204
3-way (T)	204
3-way (120)	204
4-way (X)	204
Single Height	205
Dual Height	205
Triple Height	205
End Kits	206
Wall Starter/Wall Mounted Channel	207

PANEL ACCESSORIES 208

Vertical Wire Manager	208
Metal Ceiling Module	208
Coat Hook	209
Carpet Gripper	209

COUNTER CAPS 210

Straights	210
Corners	211

FREESTANDING 212

Flat Brackets	212
Column Base	212
Tackable Privacy	213

WALL MOUNTING 214

Wall Mounting Suggestions	215
---------------------------	-----

KEY LOCK PROGRAM 216

General Information	216
How to Specify Key Alike	216
Key-alike ordered prior to 6/12/00	217

Legacy finishes are only available for existing customers to match existing installs

LAMINATES

L1

Bright White	118
Caramel Maple	MC
Clear Maple	CM
Deep Mahogany	MP58
Jet Black	111
Medium Cherry	124
Pearwood	PA
Pumice (was LF)	119
Warm Cherry	WM
White Essence	ES7
Winter Grey Matrix	MR6

EDGE BANDS

Bright White	118
Caramel Maple	MC
Clear Maple	CM
Jet Black	111
Medium Cherry	124
Pumice (was LF)	119

NOTE: If your laminate is not listed please contact Customer Service at customerservice@neutralposture.com or 979.778.0502 ext. 301 to check availability.

NOTE: Laminates and other finishes may vary in color due to different dye lots. Slight variations are normal.

PAINTS & PLASTICS

P1

Jet Black	111
Brown	112
Dark Grey (was Y3)	113
Folkstone Grey (was LA)	114
Med. Grey (was Y2)	115
Sandstone	116
Soft Grey (was E)	117
Dark Neutral	D
Taupe	R

P2

Beige Mist Metallic	611
Medium Metallic Grey	612
Beige Metallic	H
Light Tan Metallic	W

P3

Bright White	118
Silver	613

NOTE: EP1 and EP2 panels and components are not available in the following:

Bright White	118
Brown	112
Jet Black	111

PLEXIGLASS

Clear	CL
Ice	IC
Smoked	SM
Translucent	TR

FABRICS

E

Annex	KnollTextiles	W1360
Circle Line	KnollTextiles	W1146
Criss Cross	KnollTextiles	W305
Growth Spurt	KnollTextiles	W692
Photon II	KnollTextiles	W1293
Reflect	KnollTextiles	W884
Symbolic Detail	KnollTextiles	W693
Versatility	KnollTextiles	W432

F

Amplify	KnollTextiles	W1215
Foil Rap	KnollTextiles	W535
Hard Rock	KnollTextiles	W1007
Heavy Metal	KnollTextiles	W539
Micro	KnollTextiles	W465
Relay	KnollTextiles	W1020

NOTE: All 72 privacy screens require that the textile is railroaded (turned 90 degrees) for application. This must be considered when applying a patterned textile.

Generation 1 Fabric Panel

28" thru 48" High

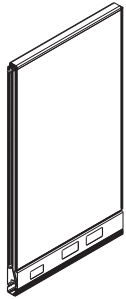

28" H

W	MODEL #	A	B	C	D	E	F	G	PAINT	
									P2	P3
12"	EP1FA1228R	\$790	\$852	\$872	\$891	\$907	\$923	\$946	N/A	+ \$60
18"	EP1FA1828R	\$822	\$887	\$904	\$926	\$940	\$962	\$984	N/A	+ \$60
24"	EP1FA2428R	\$851	\$921	\$937	\$963	\$979	\$995	\$1,025	N/A	+ \$60
30"	EP1FA3028R	\$876	\$942	\$963	\$988	\$1,008	\$1,026	\$1,052	N/A	+ \$60
36"	EP1FA3628R	\$916	\$987	\$1,007	\$1,032	\$1,053	\$1,069	\$1,098	N/A	+ \$60
42"	EP1FA4228R	\$956	\$1,029	\$1,052	\$1,079	\$1,100	\$1,116	\$1,143	N/A	+ \$60
48"	EP1FA4828R	\$990	\$1,071	\$1,088	\$1,119	\$1,139	\$1,160	\$1,190	N/A	+ \$60
60"	EP1FA6028R	\$1,055	\$1,136	\$1,159	\$1,193	\$1,212	\$1,230	\$1,264	N/A	+ \$60

40" H

12"	EP1FA1240R	\$830	\$894	\$912	\$937	\$952	\$970	\$991	N/A	+ \$60
18"	EP1FA1840R	\$869	\$937	\$956	\$979	\$995	\$1,014	\$1,038	N/A	+ \$60
24"	EP1FA2440R	\$907	\$979	\$999	\$1,027	\$1,044	\$1,064	\$1,088	N/A	+ \$60
30"	EP1FA3040R	\$936	\$1,011	\$1,028	\$1,058	\$1,076	\$1,095	\$1,121	N/A	+ \$60
36"	EP1FA3640R	\$966	\$1,044	\$1,064	\$1,091	\$1,113	\$1,130	\$1,160	N/A	+ \$60
42"	EP1FA4240R	\$1,077	\$1,161	\$1,185	\$1,216	\$1,240	\$1,259	\$1,295	N/A	+ \$60
48"	EP1FA4840R	\$1,112	\$1,201	\$1,219	\$1,254	\$1,275	\$1,299	\$1,329	N/A	+ \$60
60"	EP1FA6040R	\$1,248	\$1,348	\$1,371	\$1,410	\$1,435	\$1,458	\$1,499	N/A	+ \$60

48" H

12"	EP1FA1248R	\$852	\$922	\$938	\$964	\$980	\$999	\$1,026	N/A	+ \$60
18"	EP1FA1848R	\$895	\$967	\$984	\$1,012	\$1,029	\$1,052	\$1,076	N/A	+ \$60
24"	EP1FA2448R	\$980	\$1,061	\$1,080	\$1,100	\$1,129	\$1,150	\$1,174	N/A	+ \$60
30"	EP1FA3048R	\$1,009	\$1,088	\$1,112	\$1,139	\$1,160	\$1,180	\$1,212	N/A	+ \$60
36"	EP1FA3648R	\$1,024	\$1,105	\$1,122	\$1,154	\$1,171	\$1,194	\$1,224	N/A	+ \$60
42"	EP1FA4248R	\$1,136	\$1,226	\$1,252	\$1,283	\$1,307	\$1,329	\$1,364	N/A	+ \$60
48"	EP1FA4848R	\$1,212	\$1,307	\$1,329	\$1,367	\$1,393	\$1,415	\$1,453	N/A	+ \$60
60"	EP1FA6048R	\$1,378	\$1,491	\$1,516	\$1,555	\$1,583	\$1,612	\$1,654	N/A	+ \$60

Order Code	
e.g.	EP1FA3648R, W3513, 117
EP1FA	Fabric panel
36	Width
48	Height
R	Raceway
W351-3	Foundation, Corn Silk
117	Soft Grey trim

Specification Information	
Specify fabric and trim color. Post assemblies or connection elements must be ordered separately.	Electrical components must be ordered separately.
NOTE: Power duplexes cannot be installed on 12" W panels. Side mount receptacles available in 24" W panels and wider while using "E" series power.	NOTE: P2 trim colors are not available on EP1 panels and panel components.

Application Notes
Panel is fabric covered. If two different fabrics are used on one panel, price will reflect cost of the more expensive panel fabric.
NOTE: EP1 & EP2 Panels and components are available in legacy colors only.

Generation 1 fabric panel

53" thru 80" High



53" H

W	MODEL #	A	B	C	D	E	F	G	PAINT	
									P2	P3
12"	EP1FA1253R	\$874	\$939	\$961	\$983	\$1,001	\$1,019	\$1,048	N/A	+ \$60
18"	EP1FA1853R	\$918	\$988	\$1,008	\$1,033	\$1,055	\$1,071	\$1,100	N/A	+ \$60
24"	EP1FA2453R	\$967	\$1,048	\$1,067	\$1,095	\$1,114	\$1,131	\$1,161	N/A	+ \$60
30"	EP1FA3053R	\$991	\$1,073	\$1,091	\$1,122	\$1,141	\$1,161	\$1,193	N/A	+ \$60
36"	EP1FA3653R	\$1,141	\$1,233	\$1,258	\$1,295	\$1,314	\$1,339	\$1,371	N/A	+ \$60
42"	EP1FA4253R	\$1,194	\$1,290	\$1,314	\$1,349	\$1,371	\$1,398	\$1,433	N/A	+ \$60
48"	EP1FA4853R	\$1,261	\$1,363	\$1,388	\$1,427	\$1,451	\$1,475	\$1,514	N/A	+ \$60
60"	EP1FA6053R	\$1,433	\$1,548	\$1,575	\$1,618	\$1,647	\$1,677	\$1,719	N/A	+ \$60

60" H

12"	EP1FA1260R	\$894	\$966	\$983	\$1,011	\$1,028	\$1,048	\$1,073	N/A	+ \$60
18"	EP1FA1860R	\$946	\$1,025	\$1,042	\$1,069	\$1,085	\$1,108	\$1,136	N/A	+ \$60
24"	EP1FA2460R	\$966	\$1,044	\$1,064	\$1,091	\$1,113	\$1,130	\$1,160	N/A	+ \$60
30"	EP1FA3060R	\$1,068	\$1,154	\$1,171	\$1,210	\$1,226	\$1,251	\$1,277	N/A	+ \$60
36"	EP1FA3660R	\$1,166	\$1,259	\$1,281	\$1,317	\$1,343	\$1,364	\$1,401	N/A	+ \$60
42"	EP1FA4260R	\$1,271	\$1,371	\$1,401	\$1,436	\$1,460	\$1,486	\$1,525	N/A	+ \$60
48"	EP1FA4860R	\$1,372	\$1,485	\$1,510	\$1,551	\$1,579	\$1,605	\$1,652	N/A	+ \$60
60"	EP1FA6060R	\$1,578	\$1,705	\$1,736	\$1,783	\$1,814	\$1,846	\$1,894	N/A	+ \$60

65" H

12"	EP1FA1265R	\$940	\$1,019	\$1,035	\$1,067	\$1,083	\$1,106	\$1,130	N/A	+ \$60
18"	EP1FA1865R	\$964	\$1,041	\$1,063	\$1,088	\$1,112	\$1,126	\$1,157	N/A	+ \$60
24"	EP1FA2465R	\$1,080	\$1,168	\$1,190	\$1,219	\$1,245	\$1,264	\$1,298	N/A	+ \$60
30"	EP1FA3065R	\$1,143	\$1,236	\$1,259	\$1,297	\$1,317	\$1,340	\$1,372	N/A	+ \$60
36"	EP1FA3665R	\$1,216	\$1,314	\$1,340	\$1,373	\$1,401	\$1,423	\$1,458	N/A	+ \$60
42"	EP1FA4265R	\$1,325	\$1,435	\$1,458	\$1,500	\$1,526	\$1,551	\$1,595	N/A	+ \$60
48"	EP1FA4865R	\$1,436	\$1,550	\$1,579	\$1,621	\$1,653	\$1,681	\$1,724	N/A	+ \$60
60"	EP1FA6065R	\$1,659	\$1,790	\$1,826	\$1,876	\$1,906	\$1,941	\$1,992	N/A	+ \$60

80" H

12"	EP1FA1280R	\$960	\$1,032	\$1,053	\$1,080	\$1,101	\$1,119	\$1,150	N/A	+ \$60
18"	EP1FA1880R	\$1,019	\$1,101	\$1,121	\$1,153	\$1,170	\$1,193	\$1,221	N/A	+ \$60
24"	EP1FA2480R	\$1,085	\$1,172	\$1,197	\$1,229	\$1,252	\$1,273	\$1,304	N/A	+ \$60
30"	EP1FA3080R	\$1,219	\$1,317	\$1,346	\$1,380	\$1,404	\$1,428	\$1,463	N/A	+ \$60
36"	EP1FA3680R	\$1,362	\$1,467	\$1,497	\$1,540	\$1,566	\$1,592	\$1,632	N/A	+ \$60
42"	EP1FA4280R	\$1,499	\$1,618	\$1,647	\$1,692	\$1,724	\$1,752	\$1,797	N/A	+ \$60
48"	EP1FA4880R	\$1,632	\$1,763	\$1,793	\$1,845	\$1,877	\$1,909	\$1,957	N/A	+ \$60
60"	EP1FA6080R	\$1,904	\$2,054	\$2,094	\$2,151	\$2,190	\$2,226	\$2,285	N/A	+ \$60

Order Code	
e.g.	EP1FA2460R, W3513, 117
EP1FA	Fabric panel
24	Width
60	Height
W351-3	Foundation, Corn Silk
117	Soft Grey trim

Specification Information	
Specify fabric and trim color.	Electrical components must be ordered separately.
Post assemblies or connection elements must be ordered separately.	NOTE: P2 trim colors are not available on EP1 panels and panel components.
NOTE: Power duplexes cannot be installed on 12" W panels. Side mount receptacles available in 24" W panels and wider while using "E" series power.	

Application Notes
Panel is fabric covered. If two different fabrics are used on one panel, price will reflect cost of the more expensive panel fabric.
NOTE: EP1 & EP2 Panels and components are available in legacy colors only.

Generation 2 Insert Panel

(compatible with generation 1 panel components only)

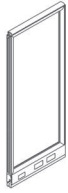

28" H

W	MODEL #	OPEN FRAME (OF)	PLEXIGLASS (PG)*	PAINT	
				P2	P3
12"	EP2()1228R	\$841	\$1,130	N/A	+ \$60
18"	EP2()1828R	\$858	\$1,212	N/A	+ \$60
24"	EP2()2428R	\$875	\$1,277	N/A	+ \$60
30"	EP2()3028R	\$894	\$1,353	N/A	+ \$60
36"	EP2()3628R	\$916	\$1,418	N/A	+ \$60
42"	EP2()4228R	\$939	\$1,532	N/A	+ \$60
48"	EP2()4828R	\$962	\$1,560	N/A	+ \$60
60"	EP2()6028R	\$1,007	\$1,700	N/A	+ \$60

40" H

12"	EP2()1240R	\$888	\$1,241	N/A	+ \$60
18"	EP2()1840R	\$906	\$1,316	N/A	+ \$60
24"	EP2()2440R	\$921	\$1,393	N/A	+ \$60
30"	EP2()3040R	\$940	\$1,533	N/A	+ \$60
36"	EP2()3640R	\$962	\$1,726	N/A	+ \$60
42"	EP2()4240R	\$987	\$1,763	N/A	+ \$60
48"	EP2()4840R	\$1,009	\$1,788	N/A	+ \$60
60"	EP2()6040R	\$1,055	\$1,970	N/A	+ \$60

48" H

12"	EP2()1248R	\$906	\$1,276	N/A	+ \$60
18"	EP2()1848R	\$924	\$1,406	N/A	+ \$60
24"	EP2()2448R	\$938	\$1,507	N/A	+ \$60
30"	EP2()3048R	\$962	\$1,640	N/A	+ \$60
36"	EP2()3648R	\$979	\$1,668	N/A	+ \$60
42"	EP2()4248R	\$1,007	\$1,838	N/A	+ \$60
48"	EP2()4848R	\$1,028	\$2,176	N/A	+ \$60
60"	EP2()6048R	\$1,071	\$2,199	N/A	+ \$60

53" H

12"	EP2()1253R	\$937	\$1,317	N/A	+ \$60
18"	EP2()1853R	\$956	\$1,445	N/A	+ \$60
24"	EP2()2453R	\$966	\$1,544	N/A	+ \$60
30"	EP2()3053R	\$990	\$1,681	N/A	+ \$60
36"	EP2()3653R	\$1,009	\$1,791	N/A	+ \$60
42"	EP2()4253R	\$1,034	\$1,990	N/A	+ \$60
48"	EP2()4853R	\$1,058	\$2,015	N/A	+ \$60
60"	EP2()6053R	\$1,105	\$2,239	N/A	+ \$60

* All Colors

Order Code	
e.g.	EP2PG3648R, PC, 613
EP2PG	Plexiglass Insert Panel
36	Width
48	Height
R	Raceway
PC	Clear
613	Silver trim

Specification Information

Specify insert type, insert color and trim color.

Application Notes

Top caps and base raceway covers are included with panels. Posts and panel connectors must be ordered separately.

NOTE: P2 trim colors are not available on EP2 panels or panel components.

Generation 2 insert panels incorporate the generation 3 mitered panel frame with generation 1 top caps and base raceway covers and will only work with generation 1 panels and panel components.

NOTE: EP1 & EP2 Panels and components are available in legacy colors only.

Generation 2 Insert Panel

(compatible with generation 1 panel components only)

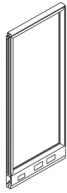

60" H

W	MODEL #	OPEN FRAME (OF)	PLEXIGLASS (PG)*	PAINT	
				P2	P3
12"	EP2()1260R	\$946	\$1,363	N/A	+\$60
18"	EP2()1860R	\$964	\$1,510	N/A	+\$60
24"	EP2()2460R	\$978	\$1,664	N/A	+\$60
30"	EP2()3060R	\$999	\$1,832	N/A	+\$60
36"	EP2()3660R	\$1,019	\$1,857	N/A	+\$60
42"	EP2()4260R	\$1,048	\$2,027	N/A	+\$60
48"	EP2()4860R	\$1,067	\$2,192	N/A	+\$60
60"	EP2()6060R	\$1,112	\$2,458	N/A	+\$60

65" H

12"	EP2()1265R	\$962	\$1,380	N/A	+\$60
18"	EP2()1865R	\$979	\$1,530	N/A	+\$60
24"	EP2()2465R	\$991	\$1,705	N/A	+\$60
30"	EP2()3065R	\$1,012	\$1,853	N/A	+\$60
36"	EP2()3665R	\$1,034	\$1,877	N/A	+\$60
42"	EP2()4265R	\$1,061	\$2,046	N/A	+\$60
48"	EP2()4865R	\$1,080	\$2,506	N/A	+\$60
60"	EP2()6065R	\$1,122	\$2,554	N/A	+\$60

80" H

12"	EP2()1280R	\$1,027	\$1,574	N/A	+\$60
18"	EP2()1880R	\$1,048	\$1,745	N/A	+\$60
24"	EP2()2480R	\$1,058	\$1,903	N/A	+\$60
30"	EP2()3080R	\$1,079	\$2,203	N/A	+\$60
36"	EP2()3680R	\$1,101	\$2,394	N/A	+\$60
42"	EP2()4280R	\$1,122	\$2,762	N/A	+\$60
48"	EP2()4880R	\$1,145	\$2,787	N/A	+\$60
60"	EP2()6080R	\$1,193	\$3,169	N/A	+\$60

* All Colors

Order Code	
e.g.	EP2PG2460R, 613
EP2PG	Plexiglass Insert Panel
24	Width
60	Height
R	Raceway
613	Silver trim

Specification Information	
Specify insert type, insert color and trim color.	NOTE: P2 trim colors are not available on EP2 panels or panel components.
Top caps and base raceway covers are included with panels. Posts and panel connectors must be ordered separately.	

Application Notes
Generation 2 insert panels incorporate the generation 3 mitered panel frame with generation 1 top caps and base raceway covers and will only work with generation 1 panels and panel components.
NOTE: EP1 & EP2 Panels and components are available in legacy colors only.

Generation 1

wall starter and wall mount channel



Panel Wall Starter

W	D	H	ACTUAL HEIGHT	MODEL #	P1	P2	P3
1½"	½"	28"	23"	EP1PWS28	\$53	N/A	\$58
1½"	½"	40"	35"	EP1PWS40	\$53	N/A	\$58
1½"	½"	48"	43"	EP1PWS48	\$58	N/A	\$62
1½"	½"	53"	48"	EP1PWS53	\$60	N/A	\$67
1½"	½"	60"	55"	EP1PWS60	\$60	N/A	\$67
1½"	½"	65"	60"	EP1PWS65	\$62	N/A	\$70
1½"	½"	80"	75"	EP1PWS80	\$70	N/A	\$83



Wall Mounted Channel

2⅞"	¾"	28"	23"	EP1WMC28	\$134	N/A	\$147
2⅞"	¾"	40"	35"	EP1WMC40	\$134	N/A	\$147
2⅞"	¾"	48"	43"	EP1WMC48	\$138	N/A	\$149
2⅞"	¾"	53"	48"	EP1WMC53	\$140	N/A	\$154
2⅞"	¾"	60"	55"	EP1WMC60	\$156	N/A	\$174
2⅞"	¾"	65"	60"	EP1WMC65	\$160	N/A	\$181
2⅞"	¾"	80"	75"	EP1WMC80	\$195	N/A	\$214
2⅞"	¾"	120"	120"	EP1WMC120	\$300	N/A	\$333

Order Code	
e.g.	EP1PWS60, 117
EP1PWS	Panel wall starter
60	Height
117	Soft Grey trim

Specification Information

Specify trim color.

NOTE: Neutral Posture, Inc. assumes no responsibility for wall construction or performance of fasteners used.

Application Notes

Wall starter:
Used to start a run of panels by fastening to an existing wall and attaching a connector assembly to it. Creates 1¼" space from face of wall to centerline of post. Constructed of steel. The wall starter includes panel top and bottom hooks and modified panel connector. Fasteners not included to attach to wall. Post and shrouds must be ordered separately.

Wall mount channel:
Allows hanging of all components and accessories on reinforced building walls. Painted extruded aluminum with a plastic inset which snaps in place, covering mounting screws.

NOTE: EP1 & EP2 Panels and components are available in legacy colors only.



Straight

W	D	H	MODEL #	P1	P2	P3
-	-	28"	EP1P28S	\$179	N/A	\$197
-	-	40"	EP1P40S	\$181	N/A	\$198
-	-	48"	EP1P48S	\$183	N/A	\$200
-	-	53"	EP1P53S	\$186	N/A	\$203
-	-	60"	EP1P60S	\$188	N/A	\$205
-	-	65"	EP1P65S	\$189	N/A	\$207
-	-	80"	EP1P80S	\$194	N/A	\$213



2-way L

-	-	28"	EP1P28L	\$173	N/A	\$188
-	-	40"	EP1P40L	\$174	N/A	\$189
-	-	48"	EP1P48L	\$175	N/A	\$194
-	-	53"	EP1P53L	\$179	N/A	\$197
-	-	60"	EP1P60L	\$181	N/A	\$198
-	-	65"	EP1P65L	\$183	N/A	\$200
-	-	80"	EP1P80L	\$188	N/A	\$205



End

-	-	28"	EP1P28E	\$189	N/A	\$207
-	-	40"	EP1P40E	\$191	N/A	\$210
-	-	48"	EP1P48E	\$194	N/A	\$213
-	-	53"	EP1P53E	\$195	N/A	\$214
-	-	60"	EP1P60E	\$197	N/A	\$215
-	-	65"	EP1P65E	\$198	N/A	\$221
-	-	80"	EP1P80E	\$202	N/A	\$226

Order Code	
e.g.	EP1P48S, 117
EP1P	Post
48	Height
S	Straight assembly
117	Soft Grey trim

Specification Information
Specify trim color.

Application Notes
Used to connect panels of the same height.
Kit includes single height post, panel connector and base raceway shroud(s) appropriate for the geometry specified.
NOTE: EP1 & EP2 Panels and components are available in legacy colors only.
Bottom levelers on post allow for up to 1½" vertical adjustment.

Generation 1

single height post assemblies three and four way



3-way (T)

W	D	H	MODEL #	P1	P2	P3
-	-	28"	EP1P28T	\$173	N/A	\$188
-	-	40"	EP1P40T	\$174	N/A	\$189
-	-	48"	EP1P48T	\$175	N/A	\$194
-	-	53"	EP1P53T	\$179	N/A	\$197
-	-	60"	EP1P60T	\$181	N/A	\$198
-	-	65"	EP1P65T	\$183	N/A	\$200
-	-	80"	EP1P80T	\$188	N/A	\$205



3-way (Y)

-	-	28"	EP1P28Y	\$215	N/A	\$243
-	-	40"	EP1P40Y	\$221	N/A	\$244
-	-	48"	EP1P48Y	\$223	N/A	\$245
-	-	53"	EP1P53Y	\$224	N/A	\$247
-	-	60"	EP1P60Y	\$226	N/A	\$248
-	-	65"	EP1P65Y	\$229	N/A	\$251
-	-	80"	EP1P80Y	\$231	N/A	\$251



4-way (X)

-	-	28"	EP1P28X	\$149	N/A	\$164
-	-	40"	EP1P40X	\$154	N/A	\$170
-	-	48"	EP1P48X	\$155	N/A	\$173
-	-	53"	EP1P53X	\$156	N/A	\$174
-	-	60"	EP1P60X	\$158	N/A	\$175
-	-	65"	EP1P65X	\$159	N/A	\$177
-	-	80"	EP1P80X	\$163	N/A	\$181

Order Code	
e.g.	EP1P80T, 117
EP1P	Post
80	Height
T	"T" assembly
117	Soft Grey trim

Specification Information
Specify trim color

Application Notes

Used to connect panels of the same height.

Kit includes single height post, panel connector and base raceway shroud(s) appropriate for the geometry specified.

NOTE: EP1 & EP2 Panels and components are available in legacy colors only.

Bottom levelers on post allow for up to 1/2" vertical adjustment.



Dual Height Post

W	D	H	MODEL #	P1	P2	P3
-	-	28"/40"	EP1DP2840	\$186	N/A	\$203
-	-	28"/48"	EP1DP2848	\$197	N/A	\$215
-	-	28"/53"	EP1DP2853	\$202	N/A	\$226
-	-	28"/60"	EP1DP2860	\$205	N/A	\$229
-	-	28"/65"	EP1DP2865	\$213	N/A	\$232
-	-	28"/80"	EP1DP2880	\$232	N/A	\$259
-	-	40"/48"	EP1DP4048	\$197	N/A	\$215
-	-	40"/53"	EP1DP4053	\$202	N/A	\$226
-	-	40"/60"	EP1DP4060	\$205	N/A	\$229
-	-	40"/65"	EP1DP4065	\$213	N/A	\$232
-	-	40"/80"	EP1DP4080	\$232	N/A	\$259
-	-	48"/53"	EP1DP4853	\$202	N/A	\$226
-	-	48"/60"	EP1DP4860	\$205	N/A	\$229
-	-	48"/65"	EP1DP4865	\$213	N/A	\$232
-	-	48"/80"	EP1DP4880	\$232	N/A	\$259
-	-	53"/60"	EP1DP5360	\$205	N/A	\$229
-	-	53"/65"	EP1DP5365	\$213	N/A	\$232
-	-	53"/80"	EP1DP5380	\$239	N/A	\$264
-	-	60"/65"	EP1DP6065	\$213	N/A	\$232
-	-	60"/80"	EP1DP6080	\$232	N/A	\$259
-	-	65"/80"	EP1DP6580	\$232	N/A	\$259

Order Code	
e.g.	EP1DP4860, 613
EP1DP	Dual height post
48	Height one
60	Height two
613	Silver

Specification Information
Specify trim color.

Application Notes
Dual height posts are used where panels of two different heights intersect.
Bottom levelers on posts allow for up to 1½" vertical adjustment.
Due to the variety of combinations possible, connector caps, shrouds and post covers must all be ordered separately.

NOTE: EP1 & EP2 Panels and components are available in legacy colors only.



Triple Height Post

W	D	H	MODEL #	P1	P2	P3
-	-	28"/40"/48"	EP1TP284048	\$232	N/A	\$259
-	-	28"/40"/53"	EP1TP284053	\$232	N/A	\$259
-	-	28"/40"/60"	EP1TP284060	\$232	N/A	\$259
-	-	28"/40"/65"	EP1TP284065	\$248	N/A	\$276
-	-	28"/40"/80"	EP1TP284080	\$277	N/A	\$305
-	-	28"/48"/53"	EP1TP284853	\$232	N/A	\$259
-	-	28"/48"/60"	EP1TP284860	\$232	N/A	\$259
-	-	28"/48"/65"	EP1TP284865	\$248	N/A	\$276
-	-	28"/48"/80"	EP1TP284880	\$277	N/A	\$305
-	-	28"/53"/60"	EP1TP285360	\$232	N/A	\$259
-	-	28"/53"/65"	EP1TP285365	\$247	N/A	\$274
-	-	28"/53"/80"	EP1TP285380	\$276	N/A	\$300
-	-	28"/60"/65"	EP1TP286065	\$248	N/A	\$276
-	-	28"/60"/80"	EP1TP286080	\$277	N/A	\$305
-	-	28"/65"/80"	EP1TP286580	\$277	N/A	\$305
-	-	40"/48"/53"	EP1TP404853	\$232	N/A	\$259
-	-	40"/48"/60"	EP1TP404860	\$232	N/A	\$259
-	-	40"/48"/65"	EP1TP404865	\$248	N/A	\$276
-	-	40"/48"/80"	EP1TP404880	\$277	N/A	\$305
-	-	40"/53"/60"	EP1TP405360	\$232	N/A	\$259
-	-	40"/53"/65"	EP1TP405365	\$247	N/A	\$274
-	-	40"/53"/80"	EP1TP405380	\$276	N/A	\$300
-	-	40"/60"/65"	EP1TP406065	\$248	N/A	\$276
-	-	40"/60"/80"	EP1TP406080	\$277	N/A	\$305
-	-	40"/65"/80"	EP1TP406580	\$277	N/A	\$305
-	-	48"/53"/60"	EP1TP485360	\$232	N/A	\$259
-	-	48"/53"/65"	EP1TP485365	\$247	N/A	\$274
-	-	48"/53"/80"	EP1TP485380	\$251	N/A	\$278
-	-	48"/60"/65"	EP1TP486065	\$248	N/A	\$276
-	-	48"/60"/80"	EP1TP486080	\$277	N/A	\$305
-	-	48"/65"/80"	EP1TP486580	\$277	N/A	\$305
-	-	53"/60"/65"	EP1TP536065	\$247	N/A	\$274
-	-	53"/60"/80"	EP1TP536080	\$250	N/A	\$277
-	-	53"/65"/80"	EP1TP536580	\$277	N/A	\$305
-	-	60"/65"/80"	EP1TP606580	\$277	N/A	\$305

Order Code	
e.g.	EP1TP406080, 113
EP1TP	Triple height post
40	Height one
60	Height two
80	Height three
113	Dark Grey trim

Specification Information
Specify trim color.

Application Notes
Triple height posts are used where 3 or 4 panels of three different heights intersect.
Bottom levelers on posts allow for up to 1½" vertical adjustment.
Due to the variety of combinations possible, connector caps, shrouds and post covers must all be ordered separately.

NOTE: EP1 & EP2 Panels and components are available in legacy colors only.

Single Height Post



W	D	H	MODEL #	P1	P2	P3
-	-	28"	EP1P28	\$86	N/A	\$93
-	-	40"	EP1P40	\$87	N/A	\$97
-	-	48"	EP1P48	\$89	N/A	\$100
-	-	53"	EP1P53	\$91	N/A	\$101
-	-	60"	EP1P60	\$92	N/A	\$103
-	-	65"	EP1P65	\$93	N/A	\$105
-	-	80"	EP1P80	\$100	N/A	\$107

Order Code	
e.g.	EP1P48, 177
EP1P	Post
48	Height
117	Soft Grey trim

Specification Information

Specify trim color.

Panel connectors and shrouds must be order separately.

Application Notes

Bottom leveler on posts allow for up to 1½" of vertical adjustment.

NOTE: EP1 & EP2 Panels and components are available in legacy colors only.

Generation 1

Panel connectors and shrouds

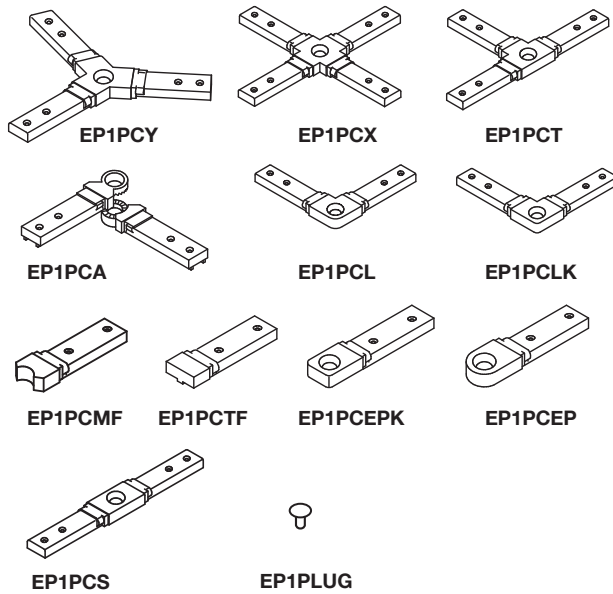

Panel Connectors

TYPE	MODEL #	P1	P2	P3
Straight	EP1PCS	\$37	\$39	\$42
2-way L	EP1PCL	\$46	\$48	\$49
2-way L (for post covers)	EP1PCLK	\$46	\$48	\$49
2-way Adjustable	EP1PCA	\$59	\$67	\$67
3-way T	EP1PCT	\$57	\$59	\$62
3-way Y 120	EP1PCY	\$57	\$59	\$62
4-way X	EP1PCX	\$62	\$67	\$75
End	EP1PCEP	\$43	\$45	\$46
End (for post covers)	EP1PCEPK	\$43	\$45	\$46
Multi-height filler	EP1PCMF	\$30	\$34	\$35
Trim filler	EP1PCTF	\$30	\$34	\$35
Post plug (pkg. of 25)	EP1PLUG	\$20	\$27	\$28

Order Code

e.g. **EP1PCEP**

EP1PC Post connector

EP End with post

Specification Information

Specify panel connector and shroud trim color.

Specify one multi-height filler (EP1PCMF) for each low panel in a multi-height connection.

NOTE: EP1 & EP2 Panels and components are available in legacy colors only.

EXCEPTION: EP1 posts connectors only are available in all colors as they may need to be specified when ordering stack-on panels with an EP3 profile.

Application Notes

Panel connectors stabilize panel to panel connections.

Panel connectors have painted finish and a quick mount design.

Mounting screws are included. Conical connector screw is included with post.

The EP1PCTF is a trim filler piece that is to be used when no other post part can be used in a given panel layout.

This piece butts against EP1PCS and EP1PCT, when installed as an addition.

Shrouds provide a finished raceway cover at posts. Two-way "L" connections do not require an inside shroud.

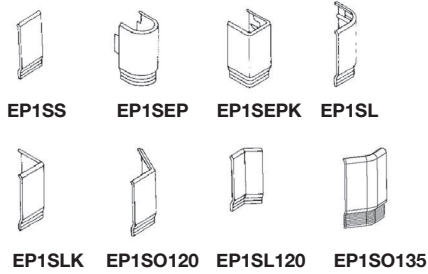

Raceway Shrouds

		P1	P2	P3
Straight	EP1SS	\$30	N/A	\$35
L outside	EP1SL	\$43	N/A	\$46
L outside (for post covers)	EP1SLK	\$43	N/A	\$46
120 outside	EP1SO120	\$34	N/A	\$37
120 inside	EP1SI120	\$20	N/A	\$28
135 outside	EP1SO135	\$34	N/A	\$37
End	EP1SEP	\$59	N/A	\$67
End (for post covers)	EP1SEPK	\$59	N/A	\$67

Order Code
e.g. EP1SEP
EP1S Post shroud
EP End with post

Specification Information
Specify panel connector and shroud trim color.
Specify one multi-height filler (EP1PCMF) for each low panel in a multi-height connection.
NOTE: EP1 & EP2 Panels and components are available in legacy colors only.
EXCEPTION: EP1 posts connectors only are available in all colors as they may need to be specified when ordering stack-on panels with an EP3 profile.

Application Notes
Panel connectors stabilize panel to panel connections.
Panel connectors have painted finish and a quick mount design.
Mounting screws are included. Conical connector screw is included with post.
The EP1PCTF is a trim filler piece that is to be used when no other post part can be used in a given panel layout.
This piece butts against EP1PCS and EP1PCT, when installed as an addition.
Shrouds provide a finished raceway cover at posts. Two-way "L" connections do not require an inside shroud.

Generation 3

Fabric Panel

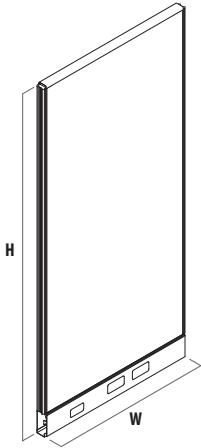

64" H

W	MODEL #	A	B	C	D	E	F	G	PAINT	
									P2	P3
12"	EP3FA1264(K/N)	\$797	\$847	\$907	\$987	\$1,107	\$1,237	\$1,387	+ \$30	+ \$60
18"	EP3FA1864(K/N)	\$857	\$907	\$967	\$1,047	\$1,167	\$1,297	\$1,447	+ \$30	+ \$60
24"	EP3FA2464(K/N)	\$918	\$968	\$1,028	\$1,108	\$1,228	\$1,358	\$1,508	+ \$30	+ \$60
30"	EP3FA3064(K/N)	\$978	\$1,028	\$1,088	\$1,168	\$1,288	\$1,418	\$1,568	+ \$30	+ \$60
36"	EP3FA3664(K/N)	\$1,074	\$1,184	\$1,314	\$1,474	\$1,724	\$2,004	\$2,324	+ \$30	+ \$60
42"	EP3FA4264(K/N)	\$1,135	\$1,245	\$1,375	\$1,535	\$1,785	\$2,065	\$2,385	+ \$30	+ \$60
48"	EP3FA4864(K/N)	\$1,195	\$1,305	\$1,435	\$1,595	\$1,845	\$2,125	\$2,445	+ \$30	+ \$60
60"	EP3FA6064(K/N)	\$1,304	\$1,414	\$1,544	\$1,704	\$1,954	\$2,234	\$2,554	+ \$30	+ \$60

EP	Equity panel	3	Beveled	FA	Fabric panel	36	29	K	With knockouts
								N	Without knockouts
EP		3		FA		36	29	K	

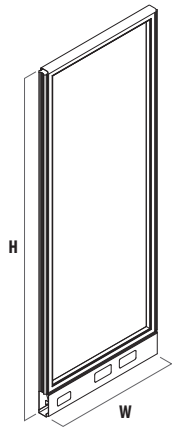

64" H

W	MODEL #	OF	GLASS INSERT			LAMINATE INSERT			PAINT	
			PG	GL	DG	L1	L2	L3	P2	P3
12"	EP3()1264(K/N)	\$962	\$1,203	\$1,348	\$1,590	\$1,300	\$1,430	\$1,560	+ \$30	+ \$60
18"	EP3()1864(K/N)	\$974	\$1,276	\$1,421	\$1,747	\$1,372	\$1,509	\$1,646	+ \$30	+ \$60
24"	EP3()2464(K/N)	\$986	\$1,361	\$1,517	\$1,940	\$1,469	\$1,616	\$1,763	+ \$30	+ \$60
30"	EP3()3064(K/N)	\$1,010	\$1,457	\$1,626	\$2,169	\$1,578	\$1,736	\$1,894	+ \$30	+ \$60
36"	EP3()3646(K/N)	\$1,034	\$1,566	\$1,735	\$2,399	\$1,686	\$1,855	\$2,023	+ \$30	+ \$60
42"	EP3()4264(K/N)	\$1,058	\$1,686	\$1,868	\$2,652	\$1,820	\$2,002	\$2,184	+ \$30	+ \$60
48"	EP3()4864(K/N)	\$1,083	\$1,820	\$2,013	\$2,918	\$1,965	\$2,162	\$2,358	+ \$30	+ \$60
60"	EP3()6064(K/N)	\$1,143	\$1,965	\$2,158	\$3,304	\$2,109	\$2,320	\$2,531	+ \$30	+ \$60

		Panel Type		W	H	Raceway	
EP3	Equity panel	OF	Open frame	36	29	K	With knockouts
		PG	Plexiglass insert			N	Without knockouts
EP		PG		36	29	K	

Pricing is for P1 paint trim colors. Add the appropriate upcharge if using P2 or P3 trim.

Generation 3

Post Assemblies

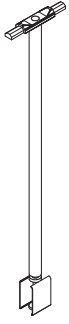

Straight

H	MODEL #	PAINT		
		P1	P2	P3
64"	EP3P64S	\$189	\$197	\$205

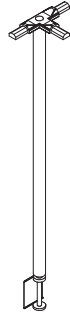

3-way T

H	MODEL #	PAINT		
		P1	P2	P3
64"	EP3P64T	\$183	\$191	\$199

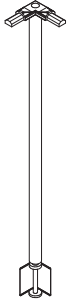

2-way L

H	MODEL #	PAINT		
		P1	P2	P3
64"	EP3P64L	\$183	\$191	\$199

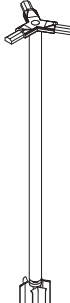

3-way 120

H	MODEL #	PAINT		
		P1	P2	P3
64"	EP3P64Y	\$229	\$239	\$249

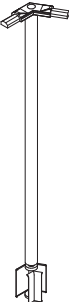

2-way 120

H	MODEL #	PAINT		
		P1	P2	P3
64"	EP3P64120	\$189	\$197	\$205

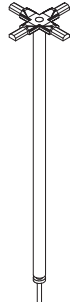

4-way X

H	MODEL #	PAINT		
		P1	P2	P3
64"	EP3P64X	\$159	\$167	\$175

Specify

1. Model #
2. Paint trim color

Application Notes

Used to connect panels of the same height

Bottom glides on post allow for up to 1 1/2" of vertical adjustment.

Assembly

- Included**
- Single height post
 - Panel connector
 - Appropriate metal shroud

Top Cap Style

3 – Beveled

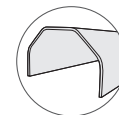

Single Height

H	MODEL #	PAINT		
		P1	P2	P3
64"	EP3P64	\$128	\$131	\$134

Dual Height

29"/64"	EP3DP2964	\$213	\$224	\$235
41"/64"	EP3DP4164	\$213	\$224	\$235
49"/64"	EP3DP4964	\$213	\$224	\$235
54"/64"	EP3DP5464	\$213	\$224	\$235
61"/64"	EP3DP6164	\$213	\$224	\$235
64"/81"	EP3DP6481	\$232	\$243	\$254

Triple Height

H	MODEL #	PAINT		
		P1	P2	P3
29"/41"/64"	EP3TP294164	\$251	\$262	\$273
29"/49"/64"	EP3TP294964	\$251	\$262	\$273
29"/54"/64"	EP3TP295464	\$251	\$262	\$273
29"/61"/64"	EP3TP296164	\$251	\$262	\$273
29"/64"/81"	EP3TP296481	\$277	\$288	\$299
41"/49"/64"	EP3TP414964	\$251	\$262	\$273
41"/54"/64"	EP3TP415464	\$251	\$262	\$273
41"/61"/64"	EP3TP416164	\$251	\$262	\$273
41"/64"/81"	EP3TP416481	\$277	\$288	\$299
49"/54"/64"	EP3TP495464	\$251	\$262	\$273
49"/61"/64"	EP3TP496164	\$264	\$275	\$286
49"/64"/81"	EP3TP496481	\$277	\$288	\$299
54"/61"/64"	EP3TP546164	\$251	\$262	\$273
54"/64"/81"	EP3TP546481	\$277	\$288	\$299
61"/64"/81"	EP3TP616481	\$277	\$288	\$299

EP3 Equity panel		P Post		H	Connection Type
EP3	P	64	S	120	2-way 120
				E	End w/post
				ETK	Postless end
				L	2-way L
				T	3-way T
				S	Straight
				X	4-way
				Y	3-way 120
				64	S

Generation 3

End Kits

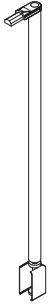

End w/Post

H	MODEL #	PAINT		
		P1	P2	P3
64"	EP3P64E	\$224	\$232	\$240



Postless End

H	MODEL #	PAINT		
		P1	P2	P3
29"	EP3ETK29	\$189	\$193	\$196
41"	EP3ETK41	\$191	\$195	\$198
49"	EP3ETK49	\$194	\$197	\$202
54"	EP3ETK54	\$196	\$200	\$204
61"	EP3ETK61	\$198	\$203	\$206
64"	EP3ETK64	\$202	\$205	\$208
66"	EP3ETK66	\$202	\$205	\$208
81"	EP3ETK81	\$212	\$215	\$219

End w/Post

Specify

1. Model #
2. Paint trim color

Application Notes

Used to finish a panel end that is not being connected to another panel.

Assembly

Included

- Single height post
- Panel connector
- Appropriate metal shroud

Top Cap Styles

3 – Beveled

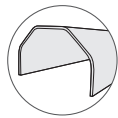

Postless End

Specify

1. Model #
2. Paint trim color

Application Notes

Used to finish a panel end that is not being connected to another panel.

NOTE: Postless end kit should not be used on panels that are placed perpendicular to a worksurface of the same depth as the front of the worksurface will extend approximately 3/4" beyond the panel end.

Assembly

Included

- Panel connector
- Appropriate metal shroud

Top Cap Styles

3 – Beveled

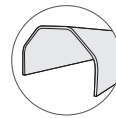



Panel Wall Starter

W	D	H	H (Actual)	MODEL #	PAINT		
					P1	P2	P3
1 ½"	½"	64"	60"	EP3PWS64	\$62	\$67	\$74



Wall Mounted Channel

W	D	H	H (Actual)	MODEL #	P1	P2	P3
2 ⅞"	¾"	64"	60"	EP3WMC64	\$160	\$173	\$178

Panel Wall Starter

Specify

1. Model #
2. Paint trim color

Application Notes

Used to start a run of panels by fastening to an existing wall and attaching a connector assembly to it. Creates 1¼" space from face to wall to centerline of post. Constructed of steel.

NOTE: Neutral Posture assumes no responsibility for wall construction or performance of fasteners used.

Assembly

Included

- Panel top & bottom hook
- Panel connector

Not Included

- Fasteners to attach to wall

Ordered Separately

- Post
- Shrouds

Top Cap Styles

3 – Beveled

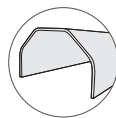

Wall Mounted Channel

Specify

1. Model #
2. Paint trim color

Application Notes

Allows hanging of all components and accessories on reinforced building walls.

Painted extruded aluminum with a plastic insert which snaps in place, covering mounting screws.

NOTE: Neutral Posture assumes no responsibility for wall construction or performance of fasteners used.

Assembly

Included

- Extruded aluminum channel
- Insert which snaps into place



Vertical Wire Manager

W	D	H	MODEL #	P1	P2	P3
½"	¾"	80"	EC1VWM80	\$35	\$37	\$39



Metal Ceiling Module

4"	1½"	120"	EE1CM40M	\$754	N/A	\$832
4"	1½"	120"	EE1CM48M	\$754	N/A	\$832
4"	1½"	120"	EE1CM53M	\$754	N/A	\$832
4"	1½"	120"	EE1CM60M	\$754	N/A	\$832
4"	1½"	120"	EE1CM65M	\$754	N/A	\$832
4"	1½"	120"	EE1CM80M	\$754	N/A	\$832

Ceiling Infeeds – Generation 3

4"	1 ½"	120"	EE3CM64M	\$754	\$792	\$832
----	------	------	-----------------	-------	-------	-------

Order Code

e.g. **EC1VWM80, 177**

EC1VWM Vertical Wire Manager

80 Length

117 Soft Grey trim

Specification Information

Specify trim color.

Vertical Wire Manager:

A plastic strip designed to hide a cord running down the edge of the panel. Cut to desired length in field.

Ceiling Infeed Modules:

Electrical harnesses not included with modules. Modules are hollow to accommodate power and/or data cables from source into systems furniture.

With electrical harness installed, infeed holds 35 CAT 5 cables.

Cables/conduit are laid into the lower metal body by removal of the front 1-½" wide access cover and into the upper plastic extrusion

by separating the front edge of the pliable tube. Infeed module is attached to an available post location of the appropriate height. The module can not be used for panel support and there are no "hang on" capabilities. Includes escutcheon plate. Plate and plastic tube are white to integrate with standard ceiling color.

No "hang on" capabilities. Module cannot be used for panel support.

Painted metal module is 120" long metal extrusion with attachment hooks at proper height to attach to appropriate height post.

To connect a metal ceiling infeed to a corner or a straight connection you must use an adjustable angle connector or adjustable angle connector with a multi-height panel connector.



EP1 Coat Hook (6/carton)

W	D	H	MODEL #	P1	P2	P3
½"	¾"	5"	EP1CH	\$145	N/A	N/A



Coat Hanger

W	D	H	MODEL #	P1	P2	P3
17"	¾"	9¼"	EP1CHG	\$18	N/A	N/A



Carpet Gripper (12 pack)

W	D	H	MODEL #	P1	P2	P3
			EP1CG12	\$45	N/A	N/A



EP3 Coat Hook Straight (5 pack)

W	D	H	MODEL #	P1	P2	P3
½"	1⅜"	2⅜"	EP3MMCH (B/P)	\$170	N/A	N/A



EP3 Coat Hook Postless End (5 pack)

W	D	H	MODEL #	P1	P2	P3
1⅜"	¾"	2⅜"	EP3MMCHPE (R/L)(B/P)	\$170	N/A	N/A

Order Code	
e.g.	EP1CH, 117
EP1CH	Coat hook
117	Soft Grey trim

Specification Information

Specify trim color.

Coat Hook and Coat Hanger available only in Dark Neutral, Medium Grey, Soft Grey or Taupe.

NOTE: EP1 & EP2 Panels and components are available in legacy colors only.

Application Notes

Coat Hanger
A plastic coat hanger available to hang on coat hook. EP1 Coat hook: Molded plastic hook hangs over EP1 panels to hold coats and hangers. Coat hook must hang over straight post location if being used w/EP3 panels. Carpet gripper:12 per package.

EP3 Coat hook
Aluminum coat hook attaches to any exposed Equity vertical slot. There are two versions. The straight version will work on any Equity vertical slot except for those on an inside corner. The postless end version is handed and extends beyond the edge of a panel with a postless end. Hand is determined by which side of the panel the coat hook is installed on while facing the panel. Available in two colors; Black (B) or Matte Aluminum (P).

Counter Caps, Straight

Generation 1 and Generation 2 profiles

Straight

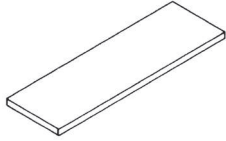

NOMINAL W	ACTUAL W	D	H	MODEL #	P1	P2	P3
12"	10.5"	15.25"	–	EW(1/2)1215	\$323	\$335	\$342
24"	22.5"	15.25"	–	EW(1/2)2415	\$358	\$365	\$375
30"	28.5"	15.25"	–	EW(1/2)3015	\$390	\$400	\$408
36"	34.5"	15.25"	–	EW(1/2)3615	\$390	\$400	\$408
42"	40.5"	15.25"	–	EW(1/2)4215	\$398	\$405	\$415
48"	46.5"	15.25"	–	EW(1/2)4815	\$401	\$412	\$420
60"	58.5"	15.25"	–	EW(1/2)6015	\$443	\$452	\$461
72"	70.5"	15.25"	–	EW(1/2)7215	\$467	\$473	\$485
84"	82.5"	15.25"	–	EW(1/2)8415	\$505	\$516	\$525
96"	94.5"	15.25"	–	EW(1/2)9615	\$525	\$536	\$544
108"	106.5"	15.25"	–	EW(1/2)10815	\$542	\$550	\$560
120"	118.5"	15.25"	–	EW(1/2)12015	\$604	\$610	\$618

Straight – Extended One End

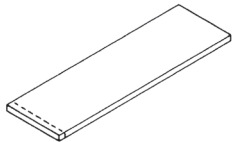

NOMINAL W	ACTUAL W	D	H	MODEL #	P1	P2	P3
12"	12"	15.25"	–	EW(1/2)1215E	\$336	\$344	\$357
24"	24"	15.25"	–	EW(1/2)2415E	\$368	\$379	\$389
30"	30"	15.25"	–	EW(1/2)3015E	\$397	\$403	\$413
36"	36"	15.25"	–	EW(1/2)3615E	\$397	\$403	\$413
42"	42"	15.25"	–	EW(1/2)4215E	\$405	\$415	\$423
48"	48"	15.25"	–	EW(1/2)4815E	\$419	\$425	\$436
60"	60"	15.25"	–	EW(1/2)6015E	\$449	\$459	\$468
72"	72"	15.25"	–	EW(1/2)7215E	\$488	\$495	\$504
84"	84"	15.25"	–	EW(1/2)8415E	\$509	\$519	\$528
96"	96"	15.25"	–	EW(1/2)9615E	\$532	\$541	\$549
108"	108"	15.25"	–	EW(1/2)10815E	\$570	\$581	\$590

Straight – Extended Both Ends

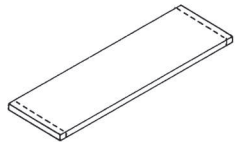

NOMINAL W	ACTUAL W	D	H	MODEL #	P1	P2	P3
12"	13.5"	15.25"	–	EW(1/2)1215EE	\$344	\$357	\$364
24"	25.5"	15.25"	–	EW(1/2)2415EE	\$384	\$392	\$401
30"	31.5"	15.25"	–	EW(1/2)3015EE	\$403	\$413	\$422
36"	37.5"	15.25"	–	EW(1/2)3615EE	\$403	\$413	\$422
42"	43.5"	15.25"	–	EW(1/2)4215EE	\$419	\$425	\$436
48"	49.5"	15.25"	–	EW(1/2)4815EE	\$467	\$473	\$485
60"	61.5"	15.25"	–	EW(1/2)6015EE	\$462	\$470	\$479
72"	73.5"	15.25"	–	EW(1/2)7215EE	\$498	\$507	\$517
84"	85.5"	15.25"	–	EW(1/2)8415EE	\$526	\$537	\$545
96"	97.5"	15.25"	–	EW(1/2)9615EE	\$542	\$550	\$560
108"	109.5"	15.25"	–	EW(1/2)10815EE	\$588	\$596	\$606

Order Code

e.g.	EW16015,117, 117, 117
EW1	Worksurface
60	Width
15	Depth
117	Soft Grey laminate
117	Soft Grey edge
117	Soft Grey cantilever trim

Specification Information

Specify surface, trim and cantilever trim color.

EW1 Counter caps work with all existing counter caps and are for use on Generation 1 or Generation 2 panels only. Plastic cantilevers are supplied.

EW2 counter caps are for use with Generation 3 panels only. Steel brackets are provided.

Counter caps are designed for mounting on top of panels.

Straight counter caps overhang both sides of the panel equally.

Counter caps fit between posts, appropriate to fit between two taller panels and a dual/triple height connectors.

A counter cap extension (E) covers one post.

A counter cap extension (EE) covers 2 posts.

Steel mounted brackets are supplied.

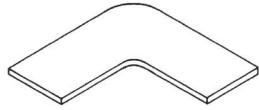

Corner

W	D	H	MODEL #	P1	P2	P3
24"	15.25"	-	EW(1/2)CC2415	\$456	\$473	\$494
30"	15.25"	-	EW(1/2)CC3015	\$489	\$505	\$525
36"	15.25"	-	EW(1/2)CC3615	\$498	\$517	\$537

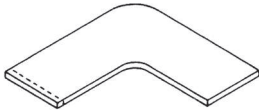

Corner – Extended Left

24"	15.25"	-	EW(1/2)CC2415LHE	\$467	\$485	\$502
30"	15.25"	-	EW(1/2)CC3015LHE	\$498	\$517	\$537
36"	15.25"	-	EW(1/2)CC3615LHE	\$509	\$528	\$546

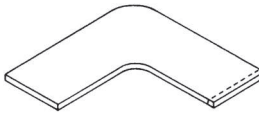

Corner – Extended Right

24"	15.25"	-	EW(1/2)CC2415RHE	\$467	\$485	\$502
30"	15.25"	-	EW(1/2)CC3015RHE	\$498	\$517	\$537
36"	15.25"	-	EW(1/2)CC3615RHE	\$509	\$528	\$546

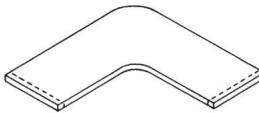

Corner – Extended Both Ends

24"	15.25"	-	EW(1/2)CC2415EE	\$485	\$502	\$521
30"	15.25"	-	EW(1/2)CC3015EE	\$526	\$545	\$562
36"	15.25"	-	EW(1/2)CC3615EE	\$537	\$557	\$572

Order Code	
e.g.	EW1CC3015, 117, 117, 117
EW1	Worksurface
CC	Curved corner
30	Width
15	Depth
117	Soft Grey laminate
117	Soft Grey edge
117	Soft Grey cantilever trim

Specification Information
Specify surface, trim and cantilever trim color.
EW1 counter caps work with all existing counter caps and are for use with Generation 1 or Generation 2 panels. Plastic cantilevers are supplied.
EW2 counter caps are for use with Generation 3 panels only.

Application Notes		
Counter caps are designed for mounting on top of panels.	They are non-handed and screw holes for the mounting brackets must be field-drilled.	A counter cap extension (E) covers one post.
Corner counter caps-(E) extended one end, mount on top of 24", 30" or 36" panels at 90° to each other.	Steel mounting brackets are supplied.	A counter cap extension (EE) covers 2 posts.

Freestanding support components

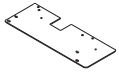

Flat Brackets (black only)

W	D	H	TOP SIZE	MODEL #.	P1	P2	P3
	15"			EB1F24	\$54	N/A	N/A
	21"			EB1F30	\$62	N/A	N/A



Column Base

		27 ³ / ₄ "		EB1FCOL	\$386	\$420	\$437
--	--	----------------------------------	--	----------------	-------	-------	-------

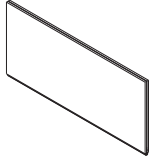

Tackable Privacy

W	D	H	MODEL #.	A	B	C	D	E	F	G
36"	¾"	21"	EF2PS36	\$473	\$513	\$520	\$534	\$544	\$552	\$569
42"	¾"	21"	EF2PS42	\$496	\$534	\$545	\$564	\$570	\$583	\$597
48"	¾"	21"	EF2PS48	\$517	\$557	\$569	\$585	\$592	\$602	\$618
60"	¾"	21"	EF2PS60	\$553	\$600	\$612	\$626	\$638	\$647	\$667
72"	¾"	21"	EF2PS72	\$592	\$641	\$653	\$671	\$681	\$693	\$714

Order Code	
e.g.	EF2OS60, 117
EF20S	Equity freestanding privacy screen
60	Length in inches
117	Soft Grey trim

Specification Information

Specify shelf and stanchion trim color where required.

NOTE: Fabric on 72" privacy screens and will be railroaded (turned 90°).

WALL MOUNTING SUGGESTIONS

The following information is provided only as a guide, and represents minimum recommendations only. Neutral Posture does not accept responsibility for the attachment of any Neutral Posture product to a Customer's site wall. Wall specification/construction is the responsibility of the Customer and its structural engineer/architect. Failure to properly attach Neutral Posture products to adequate wall structures can lead to property damage and/or personal injury.

You should consult your own structural engineers and/or architects and must not rely on the information provided herein.

It is the responsibility of the Customer and its structural engineers/architects to verify that the permanent structural walls (studs, blocks, solid masonry, etc.) on which the

Neutral Posture products are intended to be mounted are designed appropriately to support the product weight, PLUS 3 lbs. per linear inch for each usable shelf length.

NOTE: A cabinet's top is considered a "usable shelf" and MUST be included in the calculation of the total load for an overhead cabinet.

It is the responsibility of the Customer and its structural engineer/architects to specify the fasteners and method for attaching the Neutral Posture supplied wall mounting cleat, bracket, frame, etc. to the supporting wall and to confirm that the installers have adhered to these specifications. For all local building standards and codes, and additional requirements (including, but not limited to, seismic conditions) the Customer should always consult local code agencies.

New Construction

Existing Construction

	Cinder Block or Poured Concrete Masonry Wall	Wood Stud Wall, the studs being FULL HEIGHT to the roof/floor above	Wood Stud Wall, the studs being only ceiling height	Steel Stud Wall, the studs being FULL HEIGHT to the roof/floor above	Steel Stud Wall, the studs being only ceiling height	
Stud Specification	Wood studs, grade #2 or better, 3 1/2" minimum width, OR Metal studs, minimum 25 gage thickness, 3 5/8" minimum width	The wall must be a minimum of 6" thick, and must be full height to the roof/floor structure above	Wood studs must be Grade #2, or better, 3 1/2" minimum width	Wood studs must be Grade #2, or better, 3 1/2" minimum width	Metal studs must be minimum 25 gage thickness, 3 5/8" minimum width	
Stud Centers	Metal and wood studs must be spaced at 16" c/c maximum.	N/A	Wood studs must be spaced at 16" c/c maximum.	Wood studs must be spaced at 16" c/c maximum.	Metal studs must be spaced at 16" c/c maximum.	
Stud Height	Metal and wood studs must extend upwards, and be securely attached to the roof/floor structure above.			Wood studs must be braced above the ceiling, and be securely attached to the roof/floor structure above Affix #2 grade 'cap' across the top of the studs, then place diagonal studs from the top cap up to underside of the roof/floor structure above.		
Mounting the Neutral Posture Supplied Cleat, Bracket, Frame, etc	<p>Insert a 2" x 6" wood block, #2 grade or better, [or a locally approved flexible wood backing system] horizontally between each of the studs to accommodate the full width of the cabinet and beyond to the next stud.</p> <p>Fasten the wood block to each stud using three screws at the ends of each block.</p> <p>(Fasten the locally approved wood backing system as directed by the manufacturer.)</p> <p>Fasten the Neutral Posture supplied wall mounting cleat, bracket, frame, etc directly to each wood block every 6".</p> <p>For wall mounting structures that have a rectangular frame-like configuration: fasten the top horizontal element of the frame to the wood blocking every 6" and fasten the lower horizontal element to each wall stud, using one fastener per stud.</p>	<p>Fasten the Neutral Posture supplied cabinet wall mounting cleat, bracket, frame, etc. directly to the masonry wall every 6".</p> <p>For wall mounting structures that have a rectangular frame-like configuration: fasten the top horizontal element of the frame to the wall every 6" and fasten the lower horizontal element to the wall every 16".</p>	<p>In the desired location of the cabinet mounting rail, remove an 8" high section of drywall the width of the cabinet and beyond to the next stud.</p> <p>Insert a 2" x 6" wood block, #2 grade or better, horizontally between each of the exposed studs.</p> <p>Fasten the wood block to each stud using three screws at the ends of each block.</p> <p>Replace the drywall and repair as desired.</p> <p>Fasten the Neutral Posture supplied wall mounting cleat, rail, frame, etc directly to the wood block every 6".</p> <p>For wall mounting structures that have a rectangular frame-like configuration: fasten the top horizontal element of the frame to the wood blocking every 6", and fasten the lower horizontal element to each wall stud, using one fastener per stud.</p>	<p>In the desired location of the cabinet mounting rail, remove an 8" high section of drywall the width of the cabinet and beyond to the next stud.</p> <p>Insert a 2" x 6" wood block, #2 grade or better, horizontally between each of the exposed studs.</p> <p>Fasten the wood block to each stud using three screws at the ends of each block.</p> <p>Replace the drywall and repair as desired.</p> <p>Fasten the Neutral Posture supplied wall mounting cleat, rail, frame, etc directly to the wood block every 6".</p> <p>For wall mounting structures that have a rectangular frame-like configuration: fasten the top horizontal element of the frame to the wood blocking every 6", and fasten the lower horizontal element to each wall stud, using one fastener per stud.</p>	<p>In the desired location of the cabinet mounting rail, remove an 8" high section of drywall the width of the cabinet and beyond to the next stud.</p> <p>Insert a 2" x 6" wood block, #2 grade or better, [or a locally approved flexible wood backing system] horizontally between each of the exposed studs.</p> <p>Fasten the wood block to each stud using three screws at the ends of each block.</p> <p>Replace the drywall and repair as desired.</p> <p>Fasten the Neutral Posture supplied wall mounting cleat, rail, frame, etc directly to the wood block every 6".</p> <p>For wall mounting structures that have a rectangular frame-like configuration: fasten the top horizontal element of the frame to the wood blocking every 6", and fasten the lower horizontal element to each wall stud, using one fastener per stud.</p>	<p>In the desired location of the cabinet mounting rail, remove an 8" high section of drywall the width of the cabinet and beyond to the next stud.</p> <p>Insert a 2" x 6" wood block, #2 grade or better, [or a locally approved flexible wood backing system] horizontally between each of the exposed studs.</p> <p>Fasten the wood block to each stud using three screws at the ends of each block.</p> <p>Replace the drywall and repair as desired.</p> <p>Fasten the Neutral Posture supplied wall mounting cleat, rail, frame, etc directly to the wood block every 6".</p> <p>For wall mounting structures that have a rectangular frame-like configuration: fasten the top horizontal element of the frame to the wood blocking every 6" and fasten the lower horizontal element to each wall stud, using one fastener per stud.</p>
Fasten the Neutral Posture Supplied Wall Cleat With...	#10 x 2 1/2" wood screws or equiv. in every mounting hole provided, screwed directly into the wood blocking	3/16" x 3 1/2" masonry screws or equiv. in every mounting hole provided with 1 1/4" embedment, screwed directly into the masonry wall	#10 x 2 1/2" wood screws or equiv. in every mounting hole provided, screwed directly into the wood blocking	#10 x 2 1/2" wood screws or equiv. in every mounting hole provided, screwed directly into the wood blocking	#10 x 2 1/2" wood screws or equiv. in every mounting hole provided, screwed directly into the wood blocking	

Key Lock Program

GENERAL INFORMATION

Following is the Neutral Posture key lock policy, applicable to all products.

Neutral Posture pedestals, overheads, and storage cabinets ship without lock cores installed. The locks are field installed. If your purchase order does not specify key-alike you will automatically receive random lock cores with your order.

Neutral Posture furniture can be keyed-alike or random keyed.

KEY-ALIKE

Furniture may be keyed alike at no charge. Write "key-alike" in the description of your purchase order for any storage piece you wish to have keyed alike.

Using the key-alike instructions, order cores and keys as line items on your purchase order. Neutral Posture will select key numbers from the standard range of 226 – 425. Key numbers will not be repeated unless over 199 sets are ordered.

There is no charge for key-alike orders if placed with the furniture order.

If product is ordered and shipped random-keyed, additional lock cores for key-alike are billable.

KEYS

A key is shipped with every lock core. 199 Key numbers are available. For numbers above 199, contact Sales Support. Additional keys and key blanks are available.

MASTER KEYING

Neutral Posture locks can be controlled by means of a master key. There is no additional per-lock charge for master keying. Master keys must be ordered separately.

INSTALLING LOCK CORES

Lock cores can be installed or removed in the field by using a change key. Cores must be in the unlocked position to be removed. See service parts for change key pattern number and pricing.

SERVICE PARTS

MODEL #	DESCRIPTION	LIST
NLCKE_ _ _	Shrouded Key (<i>Specify key number desired</i>)	\$21
NAKC	Change Key	\$21
NKM	Master Key	\$21

NOTE: A letter of approval on company letterhead from the client must accompany all orders for master keys.

NOTE: Neutral Posture locks/keys are not compatible with Knoll Equity pedestals/double pedestals.

HOW TO SPECIFY KEY-ALIKE

Following is an example of how to specify key-alike for a cluster of 10 workstations.

STEP 1

Using the project floor plan, count the number of locks in each workstation.

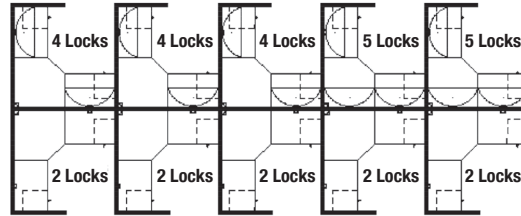

STEP 2

Count the number of workstations with the same quantity of locks. Group together the workstations with a like number of locks.

5 workstations with 2 locks per station
 3 workstations with 4 locks per station
 2 workstations with 5 locks per station

STEP 3

For the first group (5 sets of 2 locks), enter the number of workstations in the quantity column.

QTY	MODEL #	DESCRIPTION	UNIT LIST	EXT LIST
5	NSPEC 2	Set of 2 cores/keys	N / C	N / C

STEP 4

Then enter the pattern number "NSPEC_ _" and add a suffix for the number of locks for that group (i.e., for 2 locks per station, add the suffix "2"). Up to 30 lock cores are available in a set (i.e., NSPEC 30).

QTY	MODEL #	DESCRIPTION	UNIT LIST	EXT LIST
5	NSPEC 2	Set of 2 cores/keys	N / C	N / C

STEP 5

Repeat for other groups.

QTY	MODEL #	DESCRIPTION	UNIT LIST	EXT LIST
5	NSPEC 2	Set of 2 cores/keys	N / C	N / C
3	NSPEC 4	Set of 4 cores/keys	N / C	N / C
2	NSPEC 5	Set of 5 cores/keys	N / C	N / C

Your key instructions are complete.

Neutral Posture will select key numbers for each set from 199 available numbers.

For additions to existing installations, specify desired key numbers in the description.

EQUITY

In order to specify an Equity locking component with an "H" series core, apply an "A" suffix to the Equity Base pattern number.

All keyed locks in the Equity system are randomly* keyed, as a standard offering. For those requiring all locks within a workstation (or group of workstations) to be keyed alike, Equity also offers a key-alike option.

EQUITY LOCKING COMPONENTS

Identify the cabinets to be keyed alike by adding the suffix "P" to the standard catalog number (i.e., EC20F36AP indicates a key-alike EC20F36A cabinet). The cabinet will be factory-prepared with the hardware mechanisms excluding the lock core and key. List price will be reduced by \$22.

MULTIPLE KEY-ALIKE PACKAGES

For multiple keys of the same number, specify ALCKE - (number of keys desired, from 2 to 8.)
 Price is: Number of Keys x \$22. (i.e.: ALCKE-5 Pkg. of five cores with keys = \$110.00)

*Randomly keyed means that no attempt is made to assure that locks have the same number or that they are, in fact, different.

LOCK CORES

Order the lock cores required separately (ALCKE series). Cores are numbered sequentially, with up to 250 different combinations available (ALCKEH6001- ALCKEH6250). Use one line item for each quantity of lock cores to be keyed alike. Series H6001-H6100 are standard lead-time.

MASTER KEY

A master key (AKM) is available that will unlock all cabinets and pedestals with the same prefix letter, for

example: H6001, H6002. A single key is supplied and priced, as shown below.

DESCRIPTION	CATALOG NUMBER	LIST
Equity Lock and Keys	ALCKE(H6___)	\$26
Change Key	AKC	\$21
Master Key	AKM	\$21

SHIPMENT

Additional lead time of 2-4 weeks may apply when more than 100 lock sequences are specified for key-alike (contact Sales Support for current lead times).

The key-alike core and keys are shipped separately from the components for field installation in the appropriate workstation components.



NeutralPosture.com

3904 N. Texas Ave.

Bryan, TX 77803

T 979.778.0502

F 979.778.0408

GSA

SCS Indoor Advantage

BIFMA e3/LEVEL

ISO 9001:2008 Approved

