

NeutralPosture

2016 Seating Price List



TABLE OF CONTENTS

CHAIR USES MATRIX	2
NEW CHAIR SERIES	4
N-TUNE® SEATING SYSTEM	6
GUARDIAN	7

SELLING POLICY	8
Terms & Conditions	8
Ordering	8
Prices	8
Taxes	8
Lead Time	8
Storage Fee	8
Shipping	9
Freight Damage	9
Returns	9
Warranty Claims	9
Customer's Own Material	9
Delay/Force Majeure	9
Compliance with Law	9

QUICK SHIP PROGRAM	10
Overview	10
Quick Ship Fabrics	10

WARRANTY	11
Lifetime Single Shift	11
Seating Continuous-Shift Intensive Use	11

GENERAL INFORMATION	12
Patent Information	12
Certification	12
Design	12
Women's Business Enterprise (WBE)	12
Woman Owned Small Business (WOSB)	12
Historically Underutilized Business (HUB)	12
ANSI/BIFMA	12
SCS Indoor Advantage Certification	12
Custom Logos	12
Cleanroom to Class 100	12
CAL133	13
ESD Seating	13
ESD Order Form	14
COM Form	15
GSA Contract Overview	16
GSA Contract Details	17

HIGH PERFORMANCE SEATING	18
Headrest Options	20
Back Options	20
Seat Options	20
Mechanism Options	21
Arm Options	21
1000 Series	22
2000 Series	24
5000 Series	26
6000 Series – Extra Tall	28
8000 Series	30
Big & Tall	32
XSM – Extra Small	34

TASK/CONFERENCE SEATING	36
Arm Options	38
Mechanism Options	40
Balance	42
Cozi	44
Cozi Stool	46
Cozi 24/7 (Formally N-dure)	48
Cozi Guest	50
E-Series	52
Embrace	54
Embrace Guest	56
Icon – NEW	58
NV	60
NV Guest	62
Renati – NEW	64
Right Chair (Now Including Balance Ergo)	66
Right Chair Stool	68
Right Chair Mesh	70
Right Chair Mesh Stool	72
Right Chair Guest	74
U4ia	76
U4ia Stool	78
U4ia Guest	80

ACTIVE/GUEST SEATING	82
Dice	84
Facet – NEW	86
ONGO	88

INDUSTRIAL SEATING	90
AbChair	92
Adapta Stool	94
Geo	96
Graphite	98
Stratus Upholstered	100

STOOL OPTIONS	104
NeXtep	104
N-position	104
Footrings	105
Footrests	105

















WORKPLACE ACCESSORIES	106
Keyboard Arms	108
Keyboard Trays	108
Easy Combos	109
Monitor Arms	110
CPU Holders	111
StandUp	111
Forearm Supports	111
Anti-fatigue Floor Mats	111

ADJUSTABLE HEIGHT TABLES	111
---------------------------------------	------------

UPHOLSTERY	112
Fabrics	112
Leathers	113
Quick Ship Fabrics	113

















GRADED IN FABRICS	114
Carnegie	114
C.F. Stinson	115
Designtex	116
Guilford of Maine	117
Knoll	118
Luna	119
Maharam	119
Mayer	121
Momentum	123
Victor	124

Chair Uses Matrix

			Quick Ship	High Performance	Work/Task	Executive	Conference/ Training Room	Guest	Stools
		1000 Series page 22	QS	✓	✓	✓			✓
		2000 Series page 24	QS	✓	✓	✓			✓
		5000 Series page 26	QS	✓	✓				✓
		6000 Series page 28	QS	✓	✓	✓			
		8000 Series page 30	QS	✓	✓	✓			✓
		Balance™ page 42			✓	✓	✓		
		Big & Tall page 32	QS	✓	✓	✓			
		Cozi® page 44	QS		✓		✓	✓	✓
		Cozi® 24/7 page 48	QS		✓		✓	✓	✓
		Dice™ page 84						✓	

✓ Standard

Chair Uses Matrix

High Performance	Work/Task	Executive	Conference/ Training Room	Guest	Stools	Quick Ship				
	✓	✓	✓		✓	QS	E-Series™ page 52			
		✓	✓	✓			Embrace™ page 54			
				✓		QS	Facet page 86			
	✓	✓	✓		✓	QS	Icon™ page 58			
		✓	✓	✓			NV™ page 60			
			✓	✓	✓		ONGO® page 88			
	✓	✓	✓		✓	QS	Renati™ page 64			
	✓	✓	✓	✓	✓	QS	Right Chair® page 66			
	✓	✓	✓	✓	✓	QS	U4ia® page 76			
✓	✓	✓			✓	QS	XSM™ page 34			

✓ Standard

New Chair Series

ICON™

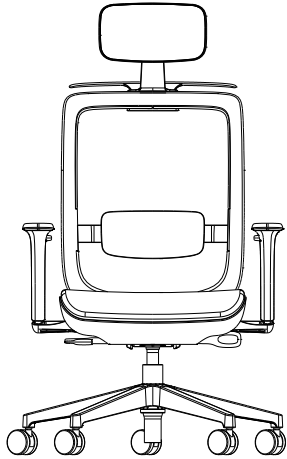

Features

- Medium gray mesh back
- Gray and black frame combination
- Replaceable/removable upholstered seat cushion – clips into place with no tools required
- Upholstery selection from Graded-in programs with select manufacturers
- Adjustable and removable lumbar support (easily slide up and down with no levers)
- Weight sensing mechanism without tension knob
- Class IV cylinder
- Finished seat bottom shell conceals mechanism
- Concealed arm adjustment
- 3 adjustment levers – height, synchro-tilt and seat slider
- Heavy-duty base and casters

page 58

RENATI™

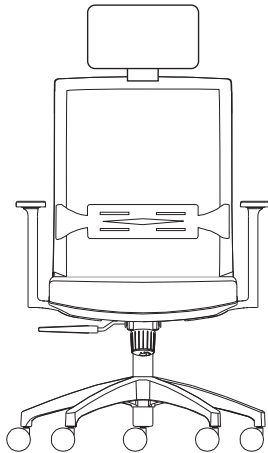

Features

- Black mesh back and frame
- Upholstery Graded-in programs with Carnegie, C.F. Stinson, Designtex, Guilford of Maine, KnollTextiles, Luna, Maharam, Mayer, Momentum, and Victor
- Tilt Swivel mechanism
- Class IV cylinder
- Heavy-duty casters and base

page 64

FACET™

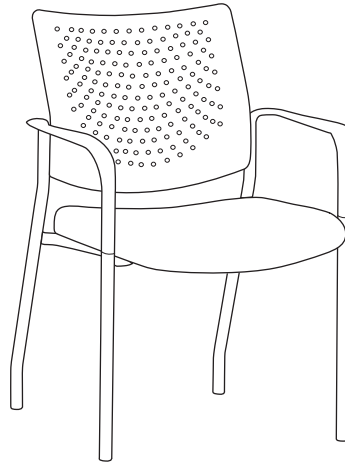

Features

- Standard black frame color
- Additional 9 frame colors available
- Two back styles – upholstered and molded plastic
- Upholstered back style stacks 5-high
- Molded plastic back style stacks 6-high
- Available with glides or casters
- Integrated wall saver leg design

page 86

START OF A REVOLUTION

N-tune®, developed by Certified Professional Ergonomists, is all about raising desk heights from 29" to 40" and then raising the chair to stool height, allowing users to easily transition between sitting and standing throughout the workday. Not only does this help alleviate the pains of a sedentary workday, the overall health benefits it provides are immense as well.

By standing for just 2 hours more than normal throughout an average workday, you can burn an extra 280 calories, translating into improvements in BMI, cholesterol, blood pressure levels and many other positive health outcomes.

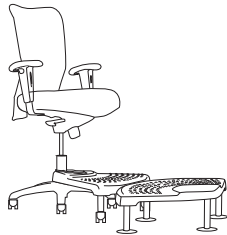
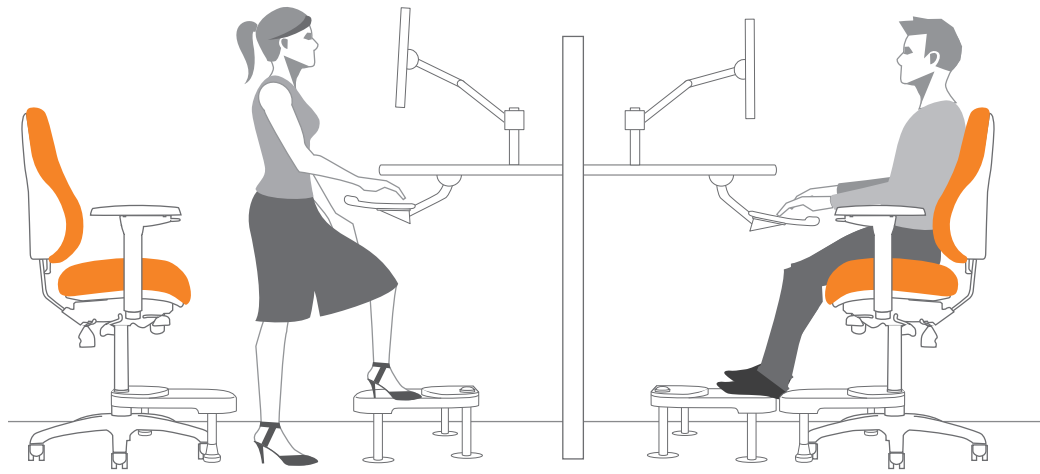

N-TUNE® SETUP — GOOD

- U4ia® with up to 13 adjustable features
- Single platform, depth adjustable 10" NeXtep®
- N-position™ with 10" platform
- N-position™ supports up to 400 lbs

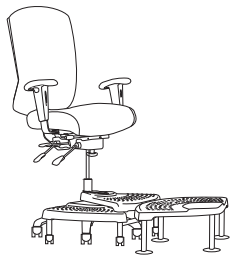

N-TUNE® SETUP — BETTER

- Cozi® with up to 13 adjustable features
- Dual platform, depth adjustable 8"/10" NeXtep® combo
- N-position™ with 10" platform
- N-position™ supports up to 400 lbs

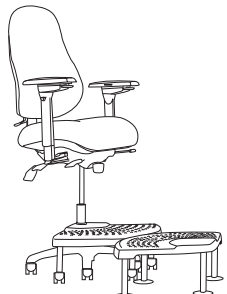

N-TUNE® SETUP — BEST

- 8000 Series with up to 15 adjustable features
- Wide single platform 10" NeXtep® provides more surface area
- N-position™ with 10" platform
- N-position™ supports up to 400 lbs

BULLET RESISTANT

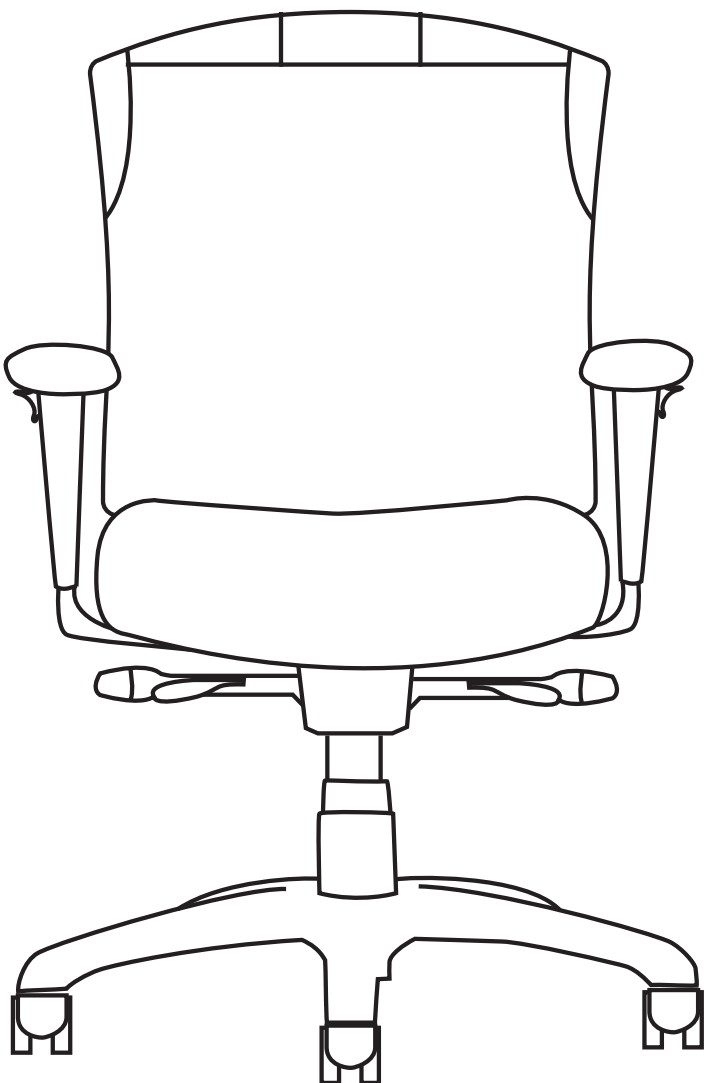

The Guardian® is a NIJ Level II compliant bullet resistant vest custom fitted over the chair's back. A NIJ Level II compliant bullet resistant vest will provide protection against regular powered 9mm handguns, up to .357 Magnums. The vest fits over the back of the chair

and is easily removable. With the vest on the chair, it can also be used as a shield by kneeling behind the back of the chair. In a situation where response time can save your life, there is no quicker solution to protection than having the Guardian® at your desk.



 NIJ Level II compliant

 Protection against regular powered 9mm handguns, up to .357 Magnums

 Use as shield or vest

 Best of NeoCon gold award winner

 Inconspicuous—looks like a regular chair

 34 standard upholstery colors available

AVAILABLE CHAIRS

Cozi page 44
 Cozi Stool page 46
 Cozi 24/7 page 48

TERMS AND CONDITIONS

For all non-rated or new accounts, payment terms are Cash in Advance (C.I.A.) until credit has been approved or rated. Please send full credit information and references and allow time for Credit Department approval.

For all established accounts, payment is due within thirty (30) days from the invoice date. Neutral Posture (NP) reserves the right to change or cancel the terms of sale based on volume, credit rating and/or credit information. Prepayment, whole or in part, may be requested at any time at the discretion of the corporate office.

Past due accounts are subject to a 1.5% late charge or maximum amount permitted under local law, for each thirty (30) days the outstanding balance remains open after the due date.

Withholding of payments based on carrier damages, shortages or other disputes is illegal and subject to charges.

ORDERING

All orders must be in writing; faxed, e-mailed or mailed. The product model number(s) contained in the order acknowledgment shall be the final expression of the order. A purchase order is not binding on NP until customer has received NP's order confirmation or acknowledgment. Orders must have a contact name and phone number. Orders may not be cancelled without written consent of Neutral Posture.

To expedite complete/correct entry of your order, be certain all model numbers, quantities, colors and area identifications are completely specified. Also, include complete purchase order number(s), bill-to and ship-to addresses, a contact name and specific shipping dates required.

Orders should be sent to:
Neutral Posture
3904 N Texas Avenue Bryan, TX 77803
979.778.0502 (Option 2)
800.446.3746
979.778.0408 FAX
E-mail: oe@neutralposture.com

When an order is received, it is assigned a scheduled ship date. That date is shown on the customer's acknowledgment.

Purchase orders may not be changed or cancelled, in whole or in part, without prior written consent of NP. Changes may affect delivery dates. Expenses incurred because of changes shall be charged to customer. In the event of cancellations, customer will be liable for reasonable cancellation charges established by NP. Orders for special product, orders including customer's own material (COM) and orders pursuant to expedited delivery programs, may not be cancelled.

A minimum of 3% of net expedite fee will be charged for orders requiring less than standard lead times.

PRICES

Prices are subject to change without notice. List prices shall be those in effect on the date of receipt of purchase order unless shipment is requested more than ninety (90) days after order entry in which case prices in effect on the date of shipment apply. Prices in effect at time of shipment prevails in the event of a discrepancy.

TAXES

All sales, use, excise and other taxes applicable to the sale of the products shall be paid by customer. If customer claims an exemption from any tax, customer shall submit to NP the appropriate exemption certificates.

LEAD TIME

Quick Ship lead time is five (5) days for products noted with Quick Ship in the price list for quantities of 25 chairs or less. 5 day Quick Ship must be requested on purchase order and is not guaranteed until acknowledged by corporate office. Lead times can vary due to fluctuation in production capacity. It is always best to confirm lead time with Sales Support. Standard lead time is 3 - 4 weeks for orders that are not Quick Ship and/or Quick Ship quantities of 26 - 300 units. For larger orders contact Sales Support for lead time.

A 3% of net expedite fee will be charged for orders requiring less than standard lead times. Less than standard lead time is clarified as less than 5 days for Quick Ship models/quantities or less than 3 - 4 weeks on non-Quick Ship models. Customer to contact NP Sales Support prior to submitting the order to confirm expediting is available for their specific order.

STORAGE FEE

Any changes made by the customer to postpone the delivery date on orders which have already gone into production, will be charged a storage fee. This fee will be applied to both partially and fully built orders. NP will advise of fee prior to applying charge.

TERMS AND CONDITIONS

SHIPPING

Most NP products include shipping. All standard discount orders are F.O.B destination delivered by parcel or prepaid freight to commercial shipping points located within the forty-eight (48) contiguous United States, District of Columbia and within Canada, excluding the Yukon, Northwest Territories, Nunavut and Newfoundland. NP will designate the shipping mode and carrier based on geographical location and best service defined by our Logistics Department.

For orders shipping outside the forty-eight (48) contiguous United States, District of Columbia and within Canada, excluding the Yukon, Northwest Territories, Nunavut and Newfoundland, customer pays shipping from port of embarkation to destination and order will be shipped "best way". Customer will incur additional charges if they choose to specify a freight carrier.

Even though shipping is included on most domestic orders, in some cases accessorial charges may apply for specialized freight services beyond normal pick up, transport and delivery such as limited access, high security, re-consignment and unusual wait times. Consignee will be responsible for paying accessorial charges relating to their orders. The following list includes, but is not limited to, accessorial charges that will apply to domestic orders. Please contact Sales Support at customerservice@neutralposture.com for a quote.

Accessorial Charges

Inside Delivery/Pick Up
Lift Gate Required
Limited Access Delivery
Notification/CBD
Residential Delivery
Ship Fully Assembled
Pre-delivery Notification
Re-delivery/Return Trip

FREIGHT DAMAGE

Upon receipt of shipment, check delivery for shortages or signs of damage. If a problem is discovered, bring it to the driver's attention immediately. If any of the goods called for on the Bill of Lading are shorted or damaged, consignees should not accept them until the carrier makes a notation on the freight bill of the shorted or damaged goods. The more precise the notation, the easier the claim can be resolved. NP's responsibility ceases when the consignee signs the freight delivery receipt as received in good condition. Shipping claims must be made within thirty (30) days of shipment delivery.

RETURNS

The return of product without written authorization by NP shall not be accepted. All merchandise returns must be pre-approved by the corporate office and sent freight prepaid. Contact the Warranty Department, warrantyrequest@neutralposture.com, to receive a Return Merchandise Authorization (RMA) number for any return. RMAs are valid for thirty (30) days and any returned merchandise without a RMA number will be refused.

No deductions from any NP invoices can be made for return merchandise until it is approved by the corporate office. No deductions will be honored until returned goods are processed through our Quality Control Audit.

All returns for cancelled orders must be pre-approved by the corporate office and sent freight prepaid. No returns will be authorized unless our inventory allows it, the parts are

in good reusable condition and it was sold within the last thirty (30) days. Authorized seating returns will be charged a thirty percent (30%) [twenty percent (20%) for GSA] restocking fee, by agreement, to cover handling, inspection, stocking and repackaging. Products not currently offered for sale by NP (including COM) shall not be authorized for return. All returned products must be unused, in original condition and in the original NP packing cartons. No refund or credit will be given for damaged products.

WARRANTY CLAIMS

Repair or replacement of defective parts under warranty will be made through NP at no cost to the customer, except for labor. Freight for products and parts covered under warranty will be covered for the forty-eight (48) contiguous states, the District of Columbia and Canada, excluding the Yukon, Northwest Territories, Nunavut and Newfoundland, with the method of shipping at NP's discretion. All claims must include the product serial number. NP will have no warranty obligation if the product was subjected to abuse, alteration, misuse, negligence or accident or if the user fails to perform the proper maintenance for the product.

CUSTOMER'S OWN MATERIAL

A customer who requests a fabric or other surface material not standard to NP's line of products (COM), must submit samples of the requested material to NP prior to entry of a customer order. NP will determine if the material is suitable to its manufacturing processes and products. The customer shall identify the COM to meet any applicable requirements of Underwriters Laboratories, CAL 117-2013, and/or Canadian Standards Association. If the COM is acceptable, NP will then establish a price for using the COM. For a description of the procedures for submitting samples and testing, contact Sales Support. NP shall have no responsibility for the appearance, condition, performance, durability, colorfastness or any other physical attribute of the COM. Customer shall indemnify and hold NP harmless for any damages, injuries or losses arising out of or related to use of the COM on the product.

DELAY/FORCE MAJEURE

Neutral Posture shall not be liable for failure to perform or for delay in performance due to fire, flood, strike or other labor difficulty, act of God, act of any governmental authority or of the customer, riot, embargo, fuel or energy shortage, wrecks or delay in transportation, inability to obtain necessary labor, materials or manufacturing facilities from usual sources or failure of suppliers to meet their contractual obligations, or due to any cause beyond its reasonable control. If any such event occurs, Neutral Posture may extend delivery dates by a period of time necessary to overcome the effect of such delay, allocate available product or cancel any purchase order.

COMPLIANCE WITH LAW

Customer is solely responsible for compliance with all applicable federal, state and local laws, ordinances, regulations, rules and standards relating to the installation, maintenance, use and operation of the products.

QUICK SHIP OVERVIEW

Neutral Posture's Quick Ship program allows customers to receive selected items sooner, for no extra charge. Items available on the Quick Ship program will be manufactured and shipped within 5 business days of an accurately specified order. Orders must be designated as Quick Ship on the PO in order to be processed as Quick Ship.

AVAILABLE CHAIRS	MAX QTY
1000 Series	25
2000 Series	25
5000 Series	25
6000 Series	25
8000 Series	25
Big & Tall	25
Cozi	25
Cozi 24/7	25
E-Series	25
Facet	25
Icon	25
Right Chair	25
Renati	25
U4ia	25
XSM	25

QUICK SHIP FABRICS

Grade 1

Spacer	Pewter	200651
Spacer	Ink	200649
Spacer	Black	200648
Spacer	Wine	200650

Grade 2

Ace	Toast	200714
Ace	Peony	200710
Ace	Char	200703
Ace	Midnight	200709
Ace	Jet	200707
Top Shelf	Cherry	
Top Shelf	Navy	
Top Shelf	Graphite	
Top Shelf	Charcoal	

Grade 3

Cloud 9	Red Dawn
Cloud 9	Midnight Sky
Cloud 9	New Haze
Cloud 9	Fog
Cloud 9	Thunder

LIFETIME SINGLE SHIFT WARRANTY

EFFECTIVE JUNE 2016

All Neutral Posture seating and accessories are warranted to the original customer to be free from defects in workmanship and materials under normal use for the product's lifetime.

Normal use is defined as wear which occurs in an office environment during the course of a normal single-shift usage workday (8 hours per day/5 days per week).

This lifetime warranty shall be for all lines and components except as noted: accessories, chair controls, arms and plastic components are warranted for twelve (12) years; inflatable lumbar is warranted for five (5) years; the ONGO® is warranted for three (3) years; upholstery is warranted for three (3) years. The upholstery warranty does not include leather, Ultra leather™, NovaSuede®, UltraSuede®, Finesse®, COM or COL.

NP's warranty obligation is limited to the replacement or repair, at NP's discretion, of defective products which have been reported by the original customer to be defective in workmanship or material and which are found to be so by NP upon inspection. Defective products shall be returned at the discretion of the corporate office and all returns must be authorized in advance. NP will assume no responsibility for any labor charges.

Freight for products and parts covered under warranty will be covered for the forty-eight (48) contiguous states and the District of Columbia with the method of shipping at NP's discretion.

The user shall be responsible for all maintenance service, which includes: lubricating and cleaning of the product, assembly, adjustment and performing operation checks.

NP will have no warranty obligation if the product was not purchased new from NP, if the product was subjected to abuse, alteration, misuse, negligence or accident or if the user fails to perform the proper maintenance for the product.

The warranty printed above is the only warranty applicable to these products. All other warranties expressed or limited, including but not limited to the implied warranties of merchantability and fitness for a particular purpose are disclaimed.

SEATING CONTINUOUS-SHIFT/ INTENSIVE USE WARRANTY

EFFECTIVE JUNE 2016

Certain Neutral Posture seating models, such as the Cozi 24/7 and Big & Tall Series, come standard with the benefits of the following continuous-shift warranty. Other Neutral Posture products may be warranted for continuous-shift through the purchase of the continuous-shift warranty. The continuous-shift warranty covers all components of the chair for a period of five (5) years from the date of purchase except for upholstery and inflatable lumbar. Only upholstery with a double rub rating of over 1M is warranted for the complete 5-year period. NP products not subject to the terms of our continuous-shift warranty, but used in such an environment (exceeding 8 hours per day/5 days per week), are to be free from defects in workmanship and materials for a period of two (2) years. NP shall have no warranty obligation if the product is subjected to abuse, alteration, misuse, negligence or accident or if the user fails to perform the proper maintenance service for the product. All other terms and conditions of the lifetime single-shift warranty apply.

Availability

Big & Tall Series	Included in Price
Cozi 24/7	Included in Price
NP Series	\$290 List Upcharge
All Other Chairs	Contact Sales Support, customerservice@neutralposture.com

Always confirm pricing/availability with Sales Support.

General Information

GENERAL INFORMATION

PATENT INFORMATION

Neutral Posture® Chair	U.S. Patent #4,552,404
AbStool®	U.S. Patent #6,877,812
	U.S. Patent #7,104,606
360° Adjustable Arms	U.S. Patent #6,296,312
Adjustment Guide	U.S. Patent #D458,777
Balance™	U.S. Patent #D541,061
Connexion® Arm	U.S. Patent #8,955,905
ElementAI®	U.S. Patent #D588,145
Fring® Footrest	U.S. Patent #6,142,571
	U.S. Patent #6,607,246
Inflatable Lumbar	U.S. Patent #6,220,663
	U.S. Patent #6,290,295
Keyboard Tray	U.S. Patent #D463,441
NeXtep®	U.S. Patent #7,036,886
N•Position™	U.S. Patent #D557,513
StandUp®	U.S. Patent #7,048,236
Cover for a	
Seating Device	U.S. Patent #D647,353
Other Patents Pending	

CERTIFICATION

Independent tests show that all NP chairs meet or exceed current ANSI/HFES 100-2007, ANSI/BIFMA and California 117 certification standards. Certain NP products meet California Technical Bulletin 133 and task intensive certification standards. All cylinders are rated Class 4 or better by UNI standards.

DESIGN

NP reserves the right to make changes and improvements in design and materials and to discontinue parts and components at their discretion.

WOMEN'S BUSINESS ENTERPRISE (WBE)

This certification is administered by the Women's Business Enterprise National Council (WBENC) and is used by most large corporations to qualify potential vendors as credible diversity suppliers.

WOMAN OWNED SMALL BUSINESS (WOSB)

The U.S. Small Business Administration's WOSB Federal Contract Program provides greater access to federal contracting opportunities for WOSBs. The program allows contracting officers to set aside specific contracts for certified WOSBs and helps federal agencies achieve the existing statutory goal of five percent of federal contracting dollars being awarded to WOSBs. NP is certified as a WOSB by WBENC.

HISTORICALLY UNDERUTILIZED BUSINESS (HUB)

The Texas Historically Underutilized Business (HUB) program encourages the use of HUBs in state procurement and provides information to minority and woman-owned businesses on the state's procurement process.

BUSINESS AND INSTITUTIONAL FURNITURE

MANUFACTURER'S ASSOCIATION

NP is a member of the Business and Institutional Furniture Manufacturer's Association (BIFMA). Tests developed by BIFMA and approved by the American National Standards Institute (ANSI) determine the strength and durability of office furniture in its everyday use. Although this testing does not serve as a warranty or guarantee, NP standard products within this price list meet or exceed applicable ANSI/BIFMA X5.1-2011, BIFMA G1-2001 and ANSI/HFES 100-2007 standards. Combinations of options added on to the standard products may not meet ANSI/ BIFMA standards. Those combinations which do not meet ANSI/BIFMA standards are not available on GSA. Additionally, most seating is BIFMA level 2 certified. For more information, contact Sales Support at customerservice@neutralposture.com.

SCS INDOOR ADVANTAGE CERTIFICATION

All NP seating products are certified by SCS Global Services for indoor air quality.

CUSTOM LOGOS

Neutral Posture can include your company, university, mascot, etc as a custom logo in embroidery on most fabrics or in Cloud 9™. Contact Sales Support at customerservice@neutralposture.com for details and cost.

CLEANROOM TO CLASS 100

Independent testing according to Federal STD 209E (correlates to ISO-14644C Class 5) confirms NP Cleanroom seating meets or exceeds Class 100 requirements. NP Cleanroom models are designed to prevent particulates in Cleanroom environments. In addition to top-quality vinyl upholstery, a HEPA filtration system in the seat and backrest prevent particulate release.

Available Chairs	Upcharge (List)
Big & Tall	\$120
Cozi	\$120
Cozi 24/7	\$120
NPS5500-D1	\$120
NPS5600-D1	\$120
AbChair (Urethane)	\$120
Adapta Stool	\$120
Stratus Upholstered	\$120
Stratus Urethane	\$70
Graphite	\$70
Geo	\$70

GENERAL INFORMATION

CAL 133

Almost every model in the NP family of seating products meets the specifications for California Technical Bulletin 117, the industry standard for upholstered furniture. Additionally, NP chairs can be upgraded to meet the more stringent, California Technical Bulletin 133 standard, which is required by the California Bureau of Home Furnishings and Thermal Insulation for contract seating used in public facilities.

Standard CAL 133 Models and Options

Fabric/Vinyl \$265 Upcharge (List)
 Leather Contact
 customerservice@neutralposture.com

Available Chairs	Options	Exceptions
5000 Series	All	Inflatable Lumbar
6000 Series	All	Inflatable Lumbar No Pillow Top All Headrests
8000 Series	All	Inflatable Lumbar All Headrests
Big & Tall	All	Inflatable Lumbar Arm Shroud Pillow Top All Headrests
AbChair	All	Urethane AbRest Cleanroom
Cozi	All	
Cozi 24/7	All	
Dice	All	Arms
Right Chair	All	
U4ia	All	

NP can also utilize COM for the CAL 133 upgrade if the material is an inherently flame retardant (FR) material, like Trevira® or Avora®. For large orders and corporate standards programs, NP can also facilitate a lab-supervised burn test for each chair/upholstery combination. These tests will be negotiated and supervised through NP's Engineering Department.

All models that comply with CAL 133 will be labeled accordingly on both the packing slip and the serial number description tag. Additionally, they will contain a label with the following notice:

Notice: This chair is manufactured in compliance with California Technical Bulletin 133 and meets the flammability requirements of the California Bureau of Home Furnishings.

ELECTROSTATIC DISCHARGE (ESD) SEATING

NP ESD models are tested to meet the requirements of today's ESD environment with conductive components and fabrics (1% carbon fiber with surface resistivity no greater than 1.3 x 10⁶ ohms/sq.cm when test in accordance with ANSI/ESD STM12.1-2006). ESD chairs are an integral part of an effective ESD system that includes a conductive floor or mat to complete conductive path.

Upholstery

- Conductive cloth or vinyl

Options

- 20" Footring
- Upholstered Back Outer
- 4" Height Adjustable Arms
- T Arms
- Drag Chain

Features

- Polished Aluminum Base

Available Chairs

Available Chairs	Upcharge (List)
5000 Series	\$290
6000 Series	\$290
8000 Series	\$290
AbChair	\$290
Adapta	\$290
Big & Tall	\$290
Cozi	\$290
Cozi Stool	\$290
Cozi 24/7	\$290
Stratus™ Upholstered	\$290
XSM™ – Extra Small	\$290

Upcharge added to graded price. Many other options and features available at an added charge. Please refer to page 14 for pricing.

ESD Order Form

Client _____

Contact Name _____

Phone Number _____

Fax Number _____

Email Address _____

City _____

State _____ Zip _____

Purchase Order Number _____

Quantity _____

Model # _____ List Price _____

Send completed form with order to:

Neutral Posture, Inc.
3904 N. Texas Avenue
Bryan, TX 77803
979.778.0502 (Option 2)
800.446.3746
979.778.0408 FAX
E-mail: oe@np-us.com

Available Chairs

- 5000 Series
- 6000 Series
- 8000 Series
- AbChair
- Adapta
- Big & Tall
- Cozi
- Cozi Stool
- Cozi 24/7
- Stratus Upholstered
- XSM – Extra Small

ESD Option – Per Chair

Up Charge

Standard ESD Package (E)

\$290

- Convert to equivalent ESD cylinder
- Convert to aluminum base
- Convert to equivalent ESD casters or glides
- The standard ESD chair is without arms.

Select Additional ESD Options

- | | | |
|--------------------------|--|-------|
| <input type="checkbox"/> | Add conductivity to Upholstered Back Outer (U)
<i>Only available on Neutral Posture® Series</i> | \$20 |
| <input type="checkbox"/> | 4" Adjustable Arms with conductivity | \$240 |
| <input type="checkbox"/> | Add conductivity to 20" Chrome Footring (R2) | \$20 |
| <input type="checkbox"/> | Drag chain
<i>Includes chain and conductivity</i> | \$30 |

Total ESD up charge per chair \$ _____

Customer's Own Material (COM) Form

Dealer Name _____

Contact Name _____

Address _____

City _____ State _____ Zip _____

Phone Number _____

Fax Number _____

Email Address _____

Client Name _____

Fabric Source (Mill) _____

Fabric Pattern Name _____

Fabric Pattern Number _____

Fabric Color _____

Backer Type (if any) _____

Fabric Orientation

Attach a fabric sample with the correct orientation

TOP

BOTTOM

Send completed form and sample yardage to:

Neutral Posture, Inc.
Attention: COM Department
3904 N. Texas Avenue
Bryan, Texas 77803
(979) 778-0502 or
com@np-us.com

We will make sure material is sent to the correct plant(s) for testing.

Preferred memo sample size is 12" x 12". Additional yardage may be required for testing.

Please make sure fabric has been approved for CAL117 flammability testing. Most industry fabrics have been tested and approved. NP may not use a fabric that has not been approved for CAL117.

NP will notify you of test results.

Contact COM Department for pricing/grading. COM yardage may vary, depending on repeat pattern. COM not covered under warranty.

All COM subject to NP testing and approval.

COM form must accompany fabric.

If fabric is a stripe please select the correct orientation:

Horizontal Vertical

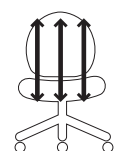

Is there a desired top?

Yes _____ No _____

If so please specify.

GSA Contract Overview

GSA CONTRACT

We have had a contract with GSA for over 20 years and they continue to be our most favored customer.

NP is dedicated to helping government agencies meet their facilities and acquisition needs. NP is registered with the System For Award Management (SAM) formerly Central Contractor Registry (CCR) with ORCA certifications, has an assigned cage code of OUTL8 and is eligible to receive federal contract awards. NP is also recognized as a Woman Owned Small Disadvantaged Business by the U.S. Small Business Administration (SBA).

WOMEN-OWNED SMALL BUSINESS (WOSB) / ECONOMICALLY DISADVANTAGED WOMEN-OWNED SMALL BUSINESS (EDWOSB)

The U. S. Small Business Administration (SBA) issued the Final Rule to amend its regulations governing small business contracting procedures. The SBA has increased the emphasis and awareness of contracting mandates regarding the new 5% spend mandate for WOSB/EDWOSB's similar to those in place for 8a, SDV and HUB Zone businesses.

The SBA has also implemented a Sole Source vehicle for Economically Disadvantaged Women-Owned Small Businesses (EDWOSB). Neutral Posture, a small business manufacturer, received this certification in April of 2016.

Our Packaged Office contract includes many great manufacturing partners and we are willing to team with other manufacturers to support strong GSA Dealers and meet the needs of our customers.

For more information please visit NeutralPosture.com/WOSB

GSA OVERVIEW

GSA Contract# GS-27F-0014Y

Schedule 71 – Furniture

SIN 71–1	Packaged Office
SIN 71–205	Chairs-Dining Room, Desk, Side, Period Style & Bar Stools
SIN 711–1	Furniture Systems & Workstation Clusters
SIN 711–11	Tables & Accessories
SIN 711–18	Multipurpose Seating
SIN 711–19	Stacking Chairs & Dollies
SIN 711–2	Worksurfaces, Workstations, Computer Furniture & Accessories
SIN 711–3	Filing and Storage Cabinets, Shelves, Mobile Carts, Dollies, Racks & Accessories
SIN 711–91	Project Management (Furniture Related)
SIN 711–94	Office Design/Layout Services
SIN 711–95	Installation Services

NAICS CODES

337214	Office Furniture (except wood) Manufacturing
337211	Wood Office Furniture Manufacturing
337127	Institutional Furniture Manufacturing
423210	Furniture Merchant Wholesalers

NP products may be found on GSA Advantage and AF Advantage.

AVAILABLE ON GSA

Products available on GSA as of June 2016. For the most current list of products available on GSA contact Sales Support or visit NeutralPosture.com.

1000 Series
2000 Series
5000 Series
6000 Series
8000 Series
Adapta
Big & Tall
Balance
Cozi
Cozi 24/7
Cozi 400
Cozi Guest
E-Series
Embrace
Embrace Guest
Equity
Facet
Geo
Graphite
Icon
NV
NV Guest
ONGO
Renati
Right Chair
Right Chair Guest
U4ia
U4ia Guest
XSM – Extra Small

NOT AVAILABLE ON GSA

Products not available on GSA as of February 2015.

AbChair
Dice
Guardian
NBF074
NBF075
P Arm
TheraGel Memory Foam

- 1a. **Special Item Numbers Awarded**
 - SIN 71-1 Packaged Office
 - SIN 71-205 Chairs-Dining Room, Desk, Side, Period Style & Bar Stools
 - SIN 711-1 Furniture Systems & Workstation Clusters
 - SIN 711-11 Tables & Accessories
 - SIN 711-18 Multipurpose Seating
 - SIN 711-19 Stacking Chairs & Dollies
 - SIN 711-2 Worksurfaces, Workstations, Computer Furniture & Accessories
 - SIN 711-3 Filing and Storage Cabinets, Shelves, Mobile Carts, Dollies, Racks & Accessories
 - SIN 711-91 Project Management (Furniture Related)
 - SIN 711-94 Office Design/Layout Services
 - SIN 711-95 Installation Services
- 1b. **Lowest Priced Item**
 - SIN 71-1 Call Corporate Office
 - SIN 71-205 ONGO \$336.00
 - SIN 711-1 EP3P29 Single Post \$32.55
 - SIN 711-11 Call Corporate Office
 - SIN 711-18 NCUGG1 Urethane \$151.20
 - SIN 711-19 NSID115 Grade C \$336.00
 - SIN 711-2 Call Corporate Office
 - SIN 711-3 SPTRY Pencil Tray \$5.95
 - SIN 711-91 Not Applicable
 - SIN 711-94 Not Applicable
 - SIN 711-95 Not Applicable
- 1c. **Installation Rate — SIN 711-1, 711-3, 711-11**
 \$51.50 per hour (non-union inclusive IFF)
 \$106.25 per hour (union inclusive of IFF)
Project Management Fee — SIN 711-91
 Senior Project Manager \$75 per hour (inclusive IFF)
 Project Manager \$55.58 per hour (inclusive IFF)
 Project Coordinator \$50 per hour (inclusive IFF)
Design/Layout Fee — SIN 711-94
 \$65 per hour (inclusive IFF)
 \$85 per hour CADD service (inclusive IFF)
2. **Maximum Order**
 - SIN 71-1 \$5,000,000
 - SIN 71-205 \$1,000,000
 - SIN 711-1 \$500,000
 - SIN 711-11 \$500,000
 - SIN 711-18 \$200,000
 - SIN 711-19 \$200,000
 - SIN 711-2 \$200,000
 - SIN 711-3 \$500,000
 - SIN 711-91 \$150,000
 - SIN 711-94 \$150,000
 - SIN 711-95 \$150,000
3. **Minimum Order**
All SINS \$50
4. **Geographic Coverage**
CONUS & OCONUS
5. **Point of Production**
3904 N. Texas Avenue, Bryan, Brazos County, Texas, USA
6. **Discount from List Price**
Seating/Workplace Accessories
 SIN 711-2, 711-18, 711-19, 711-205 — Discount 58%
Systems
 SIN 711-1, 711-3, 711-11 — Discount 65%
7. **Quantity Discounts**
No discount tiers have been negotiated.
8. **Prompt Payment Terms**
Net 30 Days
9. **Government Purchase Cards Accepted**
Visa/Master Card
10. **Foreign Item**
None
- 11a. **Time of Delivery**
5 – 90 days after receipt of order.
- 11b. **Expedited Delivery**
Expedited delivery available. Contact NP Sales Support.*
- 11c. **Overnight and 2-day Delivery**
Available with an upcharge. Contact NP Sales Support.*
12. **F.O.B. Points**
Destination/CONUS, within the 48 contiguous states and the District of Columbia. Port of embarkation for delivery to Alaska, Hawaii, Puerto Rico, the Virgin Islands and U.S. Government installations overseas.
13. **Ordering Address**
Neutral Posture, Inc.
attn: Order Entry/ * or dealer
3904 N. Texas Avenue
Bryan, TX 77803
979.778.0502
800.446.3746
fax 979.778.0408
oe@neutralposture.com
* Authorized Dealers should be cited on order
14. **Payment Address:**
Neutral Posture, Inc.
3904 N. Texas Avenue
Bryan, TX 77803
15. **Warranty Provision:**
Neutral Posture's commercial warranty applies.
16. **Export Packing Charges:**
Contact NP Sales Support for quote.*
17. **Terms and Conditions of Government Purchase Card:**
Government purchase cards will be accepted for purchases at prices shown in this authorized price list (no additional discount offered).
18. **Terms and Conditions Of Rental, Maintenance, and Repair:**
Not applicable
19. **Terms and Conditions of Installation:**
Installation and instruction are available from authorized dealers. Please contact your local NP Dealer for pricing.
20. **Terms and Conditions of Repair Parts:**
Repair parts are offered at the agreed upon discount from the NP repair parts price list in effect at the time the repair parts are ordered.
- 20a. **Terms and Conditions for Any Other Services:**
GSA has accepted all of our standard terms and conditions as noted on 6-7.
21. **List of Service and Distribution Points:**
Not applicable
22. **List of Dealers:**
Please contact NP, or visit NeutralPosture.com for the name of your nearest authorized Dealer.
23. **Preventive Maintenance:**
Not offered or applicable
24. **Environmental Attributes:**
Not applicable
25. **Other Information:**
 - Tax Identification Number (TIN): 74-2983577
 - DUNS: 61-0339723
 - Cage Code: 0UTL8
 - CEC: 61134982
 - SIC/NAICS: 2522/337214
26. **CCR:**
NP is registered in System For Award Management (SAM) formerly Central Contractor Registration (CCR) database.

NOTE: It is mandatory that all Government purchase orders be made out to NP only. Local Dealers are not authorized to accept purchase orders, issue invoices or receive payment of Government funds for these items without serious violation of this Federal Supply Schedule Contract.

HIGH PERFORMANCE SEATING

Neutral Posture's high performance chairs are truly at the top of the line in the industry when it comes to comfort. The chairs offer up to 15 adjustments ensuring that the chair will fit every inch of your body just right. Our high performance chairs are made to fit anyone and everyone, with our Neutral Posture Series chairs fitting anyone within the 5th percentile female to the 95th percentile male and the XSM and the Big and Tall fitting anyone outside that

range. These chairs are also well known for their weight dispersing abilities. Weight dispersion presents a much more comfortable seat by spreading out the weight of your body, lowering the pressure by 50%. The high performance seating is engineered as a tool to empower those who use it. The high performance seating can be used for long periods of time promoting productivity and are just as comfy at the end of the day as they were at the beginning.

HIGH PERFORMANCE SEATING

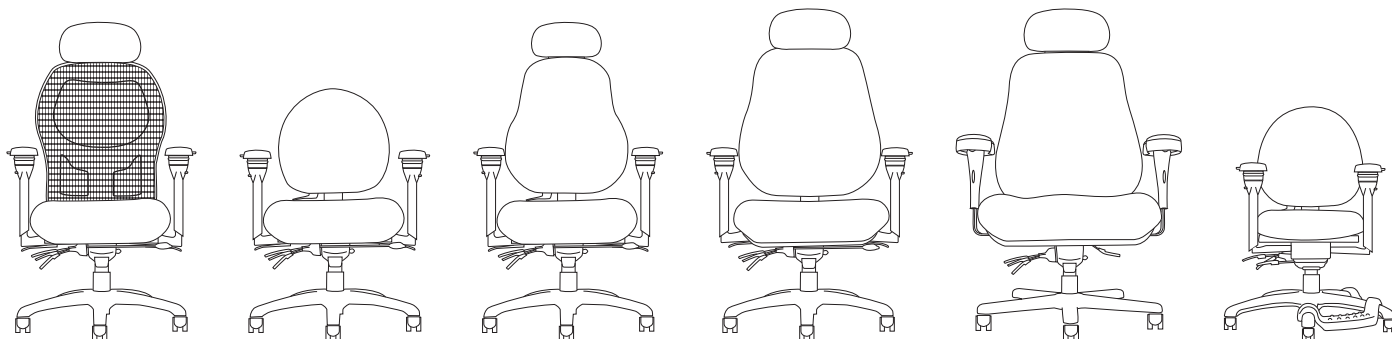

HEADREST OPTIONS

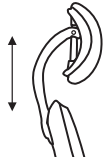

H3 HEADREST

- Black Vinyl
For mesh back
- Height

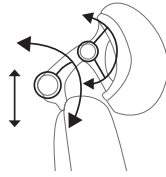

H4 HEADREST

- Matching Upholstery
- Height
 - Depth
 - 2 Pivot Points

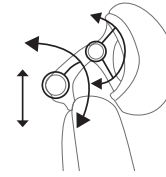

H5 HEADREST

- Black Faux Leather
- Height
 - Depth
 - 2 Pivot Points

BACK OPTIONS



1 BACK

- Not height adjustable
- Mesh back
- Independent lumbar adjustment
- Easily converts to an upholstered back with optional sleeve



6 BACK

- Height adjustable
- High back with minimal lateral contour
- Excellent upper & lower back support with inflatable lumbar
- Tallest, widest backrest
- Good choice for large users

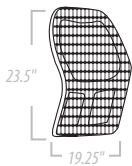

2 BACK

- Height adjustable
- Mesh back
- Independent lumbar adjustment
- Easily converts to an upholstered back with optional sleeve



8 BACK

- Height adjustable
- High back with moderate lateral contour
- Excellent upper & lower back support with inflatable lumbar
- Excellent choice for all applications



5 BACK

- Height adjustable
- Mid back with minimal lateral contour
- Excellent lower back support with inflatable lumbar
- Small profile
- Good choice for tight areas

SEAT OPTIONS



5 SEAT

- Medium Seat, Minimal Contour
- 3" thick foam eliminates "bottoming out"
 - Fits widest range of population



8 SEAT

- Large Seat, Minimal Contour
- Large dimension accommodates larger users
 - 3" thick foam eliminates "bottoming out"

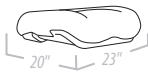

6 SEAT

- Medium Seat, Moderate Contour
- Contoured seat design minimizes seated pressure
 - 3" thick foam eliminates "bottoming out"
 - Arm post notches reduce armrest width by 2"



9 SEAT

- Large Seat, Deep Contour
- Largest contoured seat
 - Designed for larger users & to support forward tilt (i.e. neutral posture)
 - Maximizes surface contact to disperse seated pressure



7 SEAT

- Medium Seat, Deep Contour
- Most contoured seat design
 - Designed to support forward tilt (i.e. neutral posture)
 - Maximizes surface contact to disperse seated pressure

MECHANISM OPTIONS

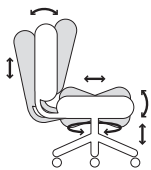

0 MECHANISM

Multi-function

- Center pivot
- Swivel 360°
- Pneumatic seat height
- Back height
(not available on 1000 Series)
- Seat angle
- Seat tension
- Independent back angle
- Forward tilt-stop
- Seat slider

ARM OPTIONS

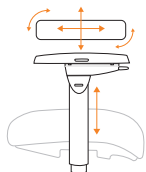

0 ARM

5-way 360°

- Height, width, depth & pivot adjustable
- 24 positive-lock angle positions in 360° range
- Arm pads slide in & out for additional width adjustment
- Arm pads slide back & forth allowing closest access to work

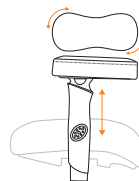

7 ARM

Oversized Fabric/Leather Arm Pads

- Height, width & pivot adjustable
- Oversized, padded arm pads provide large, extra soft surface
- 22 positive-lock angle positions in 360° range
- 180° rotation alternates long/short end positioning for access to work

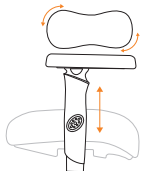

3 ARM

360° Swivel w/Oversized Urethane

- Height, width & pivot adjustable
- Oversized arm pads provide large, soft surface
- 22 positive-lock angle positions in 360° range
- 180° rotation alternates long/short end positioning for access to work

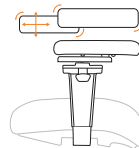

8 ARM

Friction Tracker

- Pivots on two axes for the largest depth range possible
- Provides the widest range of positioning inward & outward
- Oversized, padded & upholstered arm pads provide large, extra soft surface

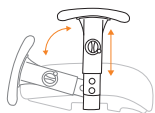

4 ARM

Swing

- Unique design swings arm down & out of the way
- Height, width & swing-down adjustable
- Excellent for multi-user applications where not all want armrests

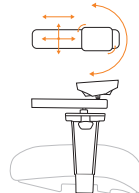

9 ARM

Ball Bearing Tracker

- Unique design supports the arm "in-task" through full range of motion
- Forearm cuff comfortably supports user's arm weight
- Exceptional for intensive arm movement tasks
- Not recommend for general use

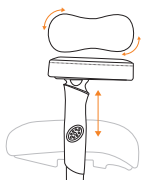

6 ARM

Oversized Black Vinyl Arm Pads

- Height, width & pivot adjustable
- Oversized, padded arm pads provide large, extra soft surface
- 22 positive-lock angle positions in 360° range
- 180° rotation alternates long/short end positioning for access to work



P ARM

360° Swivel

- Height, width & pivot adjustable
- 22 positive-lock angle positions in 360° range
- 180° rotation alternates long/short end positioning for access to work

1000 Series

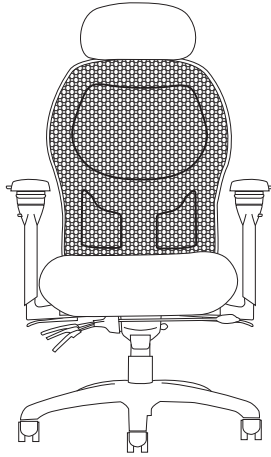

NPS1500-H4

Features

- Up to 14 active adjustments
- Mesh back
- Independent lumbar
- Generous foam for optimal comfort
- Convert mesh back to upholstered w/optional sleeve
- 2 headrest options

Standard Features

- 5-way 360° Arms
- Carpet Casters
- 26" Black Base
- 5" Cylinder
- Seat Slider

Need it Now? 5-day Quick Ship

Only standard features are available as Quick Ship unless otherwise noted.

QUICK SHIP ARMS

- 0 5-way 360°
5 No Arms

QUICK SHIP FABRICS

For available quick ship fabrics see page 10.

Step 1 — Model Number

Series Code	Back	Select a Seat	Select an Arm	Mech
NPS Neutral Posture Series	1 Mesh Back	5 Medium Seat, Minimal Contour 6 Medium Seat, Moderate Contour 7 Medium Seat, Deep Contour 8 Large Seat, Minimal Contour	0 5-way 360° \$0 3 360° w/Oversized Urethane \$75 4 Swing \$155 5 No Arms (\$140) 6 360° w/Oversized Black Vinyl \$225 7 360° w/Oversized Fabric/Leather \$265 8 Friction Tracker \$420 9 Ball Bearing Tracker \$420 P 360° Swivel \$0	0 Multi-function 
NPS	1	5	0	0



NPS1500	NPS1600	NPS1700	NPS1800
\$1,238	\$1,305	\$1,316	\$1,316
\$1,298	\$1,365	\$1,376	\$1,376
\$1,358	\$1,425	\$1,436	\$1,436
\$1,428	\$1,495	\$1,506	\$1,506
\$1,498	\$1,565	\$1,576	\$1,576
\$1,578	\$1,645	\$1,656	\$1,656
\$1,658	\$1,725	\$1,736	\$1,736
\$1,748	\$1,815	\$1,826	\$1,826
\$1,838	\$1,905	\$1,916	\$1,916

40 x 26 x 26	40 x 26 x 26	40 x 26 x 26	40 x 26 x 26
56 lbs	56 lbs	61 lbs	61 lbs
21	23	23	23
17.5 – 22.5	17.5 – 22.5	17.5 – 22.5	18.25 – 23.25
15.5 – 18	16 – 18.5	16 – 18.5	18 – 20.5
F3° – R11°	F9° – R6°	F10° – R3°	F5° – R7°
19	19	19	19
21	21	21	21
95° – 114°	100° – 126°	103° – 123°	102° – 109°
3	3	3	3
7 – 11	7 – 11	7 – 11	6.5 – 10.5
15.75 – 22.25	15.75 – 22.25	18 – 22.25	18 – 22.25
26	26	26	26
1 yd	1 yd	1 yd	1 yd
28 x 26 x 24	28 x 26 x 24	28 x 26 x 24	28 x 26 x 24
66 lbs	66 lbs	71 lbs	71 lbs
KD	KD	KD	KD

All measurements are nominal and shown in inches. Specs may differ for stools.

- Grade 1
- Grade 2
- Grade 3
- Grade 4
- Grade 5
- Grade 6
- Grade 7
- Grade 8
- Grade 9

- Chair (H x W x D)
- Chair Weight
- Seat Width
- Seat Height
- Seat Depth
- Seat Angle
- Back Width
- Back Height
- Back Angle
- Lumbar Range
- Arm Height
- Arm Width
- Base Diameter
- COM Yardage
- Shipping Box (L x W x H)
- Shipping Weight
- Shipping Method

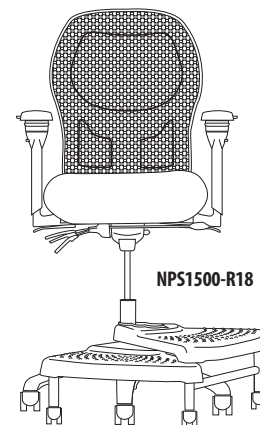

NPS1500-R18

Step 2 — Add option codes after model number NPS1500 - __ - __

General

CR	Cleanroom to Class 100	\$120
CX	Coccyx Cutout	\$215
	<i>Cloud 9™, Revive™ & Top Shelf</i>	
F	Fring® Footrest	\$50
	<i>Only available on (B0) base</i>	
N	N-dulgent® Memory Foam	\$75
N2	TheraGel™ Memory Foam	\$150

Back Sleeve

S1	Grade 1	\$95
S2	Grade 2	\$135
SS	Ultrasleather™	\$250

Casters/Glides

C0	Carpet	\$0
C1	Hard Floor	\$25
C2	Glides	\$25
C3	Occupied Braking	\$185
C4	Unoccupied Braking	\$60
C8	Chrome Carpet	\$90
C9	Chrome Hard Floor	\$100

Bases

B0	26" Black	\$0
B6	26" Polished Aluminum	\$140
	<i>Recommended with (L1)</i>	
B8	27" Brushed Aluminum	\$140
	<i>Recommended with (L1)</i>	
B12	28" Black	\$110

Chair Cylinders

L1	3" Cylinder	\$0
L3	5" Cylinder	\$0
Headrests		
HE	Height Adjustable	\$60
	<i>Black vinyl</i>	
H5	Dual Pivot	\$280
	<i>Black faux leather</i>	

Connexion® Arm

Z1	Connexion Arm	\$350
	<i>Only available on (5) & (6) seat</i>	

Connexion® Arm Attachments

A1	Tablet Holder	\$149
-----------	----------------------	-------

Stool Options

Stool Cylinders

L4	8" Cylinder	\$55
L5	10" Cylinder	\$55
L7	7" Cylinder	\$55

Footrings for stool cylinders only

R1	18" Black Plastic	\$60
R2	20" Chrome	\$80

NeXtep® for stool cylinders only

R8	8" w/Casters	\$185
R10	10" w/Casters	\$185
R18	8"/10" w/Casters	\$295
RW8	Wide 8" w/Casters	\$295
RW10	Wide 10" w/Casters	\$295

Also available w/glides.

For additional stool options see page 104.

2000 Series

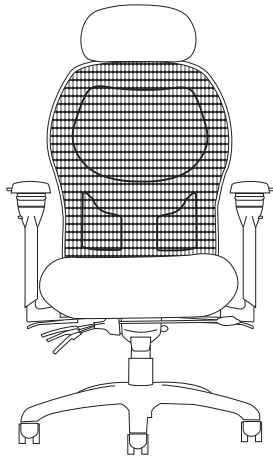

NPS2500-H5

Features

- Up to 15 active adjustments
- High performance, height adjustable mesh back
- Independent lumbar
- Generous foam for optimal comfort
- Convert mesh back to upholstered w/optional sleeve
- 2 headrest options

Standard Features

- 5-way 360° Arms
- Carpet Casters
- 26" Black Base
- 5" Cylinder
- Seat Slider

Need it Now? 5-day Quick Ship

Only standard features are available as Quick Ship unless otherwise noted.

QUICK SHIP ARMS

- 0 5-way 360°
- 5 No Arms

QUICK SHIP FABRICS

For available quick ship fabrics see page 10.

Step 1 — Model Number

Series Code	Back	Select a Seat	Select an Arm	Mech
NPS Neutral Posture Series	2 Mesh Back	5 Medium Seat, Minimal Contour 6 Medium Seat, Moderate Contour 7 Medium Seat, Deep Contour 8 Large Seat, Minimal Contour	0 5-way 360° \$0 3 360° w/Oversized Urethane \$75 4 Swing \$155 5 No Arms (\$140) 6 360° w/Oversized Black Vinyl \$225 7 360° w/Oversized Fabric/Leather \$265 8 Friction Tracker \$420 9 Ball Bearing Tracker \$420 P 360° Swivel \$0	0 Multi-function 
NPS	2	5	0	0



NPS2500	NPS2600	NPS2700	NPS2800
\$1,420	\$1,487	\$1,498	\$1,498
\$1,480	\$1,547	\$1,558	\$1,558
\$1,540	\$1,607	\$1,618	\$1,618
\$1,610	\$1,677	\$1,688	\$1,688
\$1,680	\$1,747	\$1,758	\$1,758
\$1,760	\$1,827	\$1,838	\$1,838
\$1,840	\$1,907	\$1,918	\$1,918
\$1,930	\$1,997	\$2,008	\$2,008
\$2,020	\$2,087	\$2,098	\$2,098

39 x 26 x 26	39 x 26 x 26	39 x 27 x 26	39 x 27 x 26
56 lbs	56 lbs	61 lbs	61 lbs
21	23	23	23
17.5 – 22.5	17.5 – 22.5	17.5 – 22.5	18.25 – 23.25
15.5 – 18	16 – 18.5	16 – 18.5	18 – 20.5
F3° – R11°	F9° – R6°	F10° – R3°	F5° – R7°
19	19	19	19
21 – 25	21 – 25	22 – 26	21 – 25
95° – 114°	100° – 126°	103° – 123°	102° – 109°
4	4	4	4
7 – 11	7 – 11	7 – 11	6.5 – 10.5
15.75 – 22.25	15.75 – 22.25	18 – 22.25	18 – 22.25
26	26	26	26
1 yd	1 yd	1 yd	1 yd
28 x 26 x 24	28 x 26 x 24	28 x 26 x 24	28 x 26 x 24
66 lbs	66 lbs	71 lbs	71 lbs
KD	KD	KD	KD

All measurements are nominal and shown in inches. Specs may differ for stools.

- Grade 1
- Grade 2
- Grade 3
- Grade 4
- Grade 5
- Grade 6
- Grade 7
- Grade 8
- Grade 9

- Chair (H x W x D)
- Chair Weight
- Seat Width
- Seat Height
- Seat Depth
- Seat Angle
- Back Width
- Back Height
- Back Angle
- Lumbar Range
- Arm Height
- Arm Width
- Base Diameter
- COM Yardage
- Shipping Box (L x W x H)
- Shipping Weight
- Shipping Method

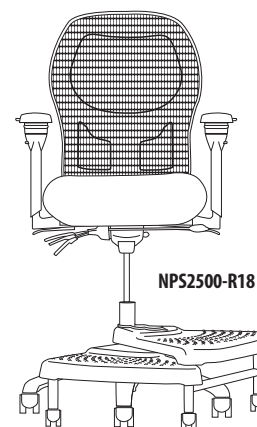

NPS2500-R18

Step 2 — Add option codes after model number NPS2500 - __ - __

General		Casters/Glides		Chair Cylinders		Stool Cylinders		
CR	Cleanroom to Class 100	\$120	C0	Carpet	\$0	L4	8" Cylinder	\$55
CX	Coccyx Cutout	\$215	C1	Hard Floor	\$25	L5	10" Cylinder	\$55
	<i>Cloud 9™, Revive™ & Top Shelf</i>		C2	Glides	\$25	L7	7" Cylinder	\$55
F	Fring® Footrest	\$50	C3	Occupied Braking	\$185	Headrests		
	<i>Only available on (B0)</i>		C4	Unoccupied Braking	\$60	HE	Height Adjustable	\$60
N	N-dulgent® Memory Foam	\$75	C8	Chrome Carpet	\$90		<i>Black vinyl</i>	
N2	TheraGel™ Memory Foam	\$150	C9	Chrome Hard Floor	\$100	H5	Dual Pivot	\$280
							<i>Black faux leather</i>	
Back Sleeve			Bases			Connexion® Arm		
S1	Grade 1	\$95	B0	26" Black	\$0	Z1	Connexion Arm	\$350
S2	Grade 2	\$135	B6	26" Polished Aluminum	\$140		<i>Only available on (5) & (6) seat</i>	
SS	Ultraleather™	\$250	B8	27" Brushed Aluminum	\$140	Connexion® Arm Attachments		
				<i>Recommended with (L1)</i>		A1	Tablet Holder	\$149
			B12	28" Black	\$110	Footrings for stool cylinders only		
				<i>Recommended with (L1)</i>		R1	18" Black Plastic	\$60
						R2	20" Chrome	\$80
						NeXtep® for stool cylinders only		
						R8	8" w/Casters	\$185
						R10	10" w/Casters	\$185
						R18	8"/10" w/Casters	\$295
						RW8	Wide 8" w/Casters	\$295
						RW10	Wide 10" w/Casters	\$295

Also available w/glides.

For additional stool options see page 104.

5000 Series

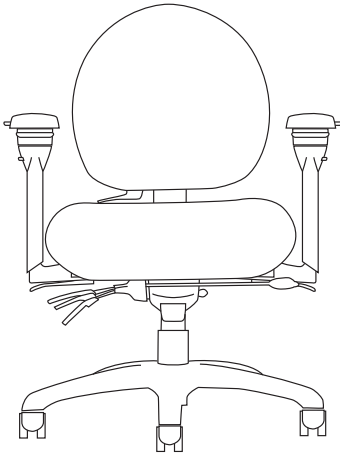

NPS5500

Features

- Up to 12 active adjustments
- Mid back & contoured seat designs
- Passive weight dispersion design
- Generous foam for optimal comfort
- Inflatable lumbar

Standard Features

- 5-way 360° Arms
- Carpet Casters
- 26" Black Base
- 5" Cylinder
- Seat Slider

Need it Now? 5-day Quick Ship

Only standard features are available as Quick Ship unless otherwise noted.

QUICK SHIP ARMS

- 0 5-way 360°
- 5 No Arms

QUICK SHIP FABRICS

For available quick ship fabrics see page 10.

Step 1 — Model Number

Series Code	Back	Select a Seat	Select an Arm	Mech
NPS Neutral Posture Series	5 Mid Back	5 Medium Seat, Minimal Contour 6 Medium Seat, Moderate Contour 7 Medium Seat, Deep Contour 8 Large Seat, Minimal Contour 9 Large Seat, Deep Contour	0 5-way 360° \$0 3 360° w/Oversized Urethane \$75 4 Swing \$155 5 No Arms (\$140) 6 360° w/Oversized Black Vinyl \$225 7 360° w/Oversized Fabric/Leather \$265 8 Friction Tracker \$420 9 Ball Bearing Tracker \$420 P 360° Swivel \$0	0 Multi-function 
NPS	5	5	0	0



NPS5500	NPS5600	NPS5700	NPS5800	NPS5900
\$1,284	\$1,352	\$1,362	\$1,362	\$1,399
\$1,344	\$1,412	\$1,422	\$1,422	\$1,459
\$1,404	\$1,472	\$1,482	\$1,482	\$1,519
\$1,474	\$1,542	\$1,552	\$1,552	\$1,589
\$1,544	\$1,612	\$1,622	\$1,622	\$1,659
\$1,624	\$1,692	\$1,702	\$1,702	\$1,739
\$1,704	\$1,772	\$1,782	\$1,782	\$1,819
\$1,794	\$1,862	\$1,872	\$1,872	\$1,909
\$1,884	\$1,952	\$1,962	\$1,962	\$1,999

36 x 26 x 26	36 x 26 x 26	36 x 26 x 26	36 x 26 x 26	36 x 26 x 26
52.5 lbs	52.5 lbs	57 lbs	57 lbs	57 lbs
21	23	23	23	25
17.5 – 22.5	17.5 – 22.5	17.5 – 22.5	18.25 – 23.5	17.5 – 22.5
15.5 – 18	16 – 18.5	16 – 18.5	18 – 20.5	19 – 21.5
F3° – R11°	F9° – R6°	F10° – R3°	F5° – R7°	F8° – R6°
17.5	17.5	17.5	17.5	17.5
17 – 21	17 – 21	16 – 20	17 – 21	16 – 20
102° – 122°	107° – 122°	107° – 124°	108° – 128°	102° – 118°
4	4	4	4	4
7 – 11	7 – 11	7 – 11	6.5 – 10.5	6.5 – 10.5
15.75 – 22.25	15.75 – 22.25	18 – 22.25	18 – 22.25	18.5 – 22.25
26	26	26	26	26
2 yd	2 yd	2 yd	2 yd	2 yd
28 x 26 x 24	28 x 26 x 24	28 x 26 x 24	28 x 26 x 24	28 x 26 x 24
62.5 lbs	62.5 lbs	67 lbs	67 lbs	67 lbs
KD	KD	KD	KD	FA

All measurements are nominal and shown in inches. Specs may differ for stools.

- Grade 1
- Grade 2
- Grade 3
- Grade 4
- Grade 5
- Grade 6
- Grade 7
- Grade 8
- Grade 9

- Chair (H x W x D)
- Chair Weight
- Seat Width
- Seat Height
- Seat Depth
- Seat Angle
- Back Width
- Back Height
- Back Angle
- Lumbar Range
- Arm Height
- Arm Width
- Base Diameter
- COM Yardage
- Shipping Box (L x W x H)
- Shipping Weight
- Shipping Method

Upholstered Back Outer		
U1	Grade 1	\$120
U2	Grade 2	\$140
U3	Grade 3	\$160
U4	Grade 4	\$180
U5	Grade 5	\$200
U6	Grade 6	\$220
U7	Grade 7	\$240
U8	Grade 8	\$260
U9	Grade 9	\$280

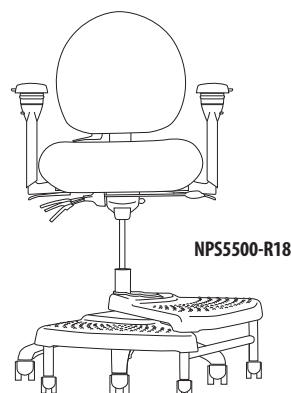

Step 2 — Add option codes after model number NPS5500 - __ - __

General	Casters/Glides	Chair Cylinders
A Thoracic Support \$80	C0 Carpet \$0	L1 3" Cylinder \$0
CR Cleanroom to Class 100 \$120	C1 Hard Floor \$25	L3 5" Cylinder \$0
CX Coccyx Cutout \$215 <i>Cloud 9™, Revive™ & Top Shelf</i>	C2 Glides \$25	Connexion® Arm
D1 No Inflatable Lumbar (\$50)	C3 Occupied Braking \$185	Z1 Connexion Arm \$350 <i>Only available on (5) & (6) seat</i>
E ESD* \$290	C4 Unoccupied Braking \$60	Connexion® Arm Attachments
F Fring® Footrest \$50 <i>Only available on (B0) base</i>	C8 Chrome Carpet \$90	A1 Tablet Holder \$149
N N-dulgent® Memory Foam \$125	C9 Chrome Hard Floor \$100	
N2 TheraGel™ Memory Foam \$150	Bases	
	B0 26" Black \$0	
	B6 26" Polished Aluminum \$140 <i>Recommended with (L1)</i>	
	B8 27" Brushed Aluminum \$140 <i>Recommended with (L1)</i>	
	B12 28" Black \$110	

Stool Options

Stool Cylinders	Footrings for stool cylinders only	NeXtep® for stool cylinders only
L4 8" Cylinder \$55	R1 18" Black Plastic \$60	R8 8" w/Casters \$185
L5 10" Cylinder \$55	R2 20" Chrome \$80	R10 10" w/Casters \$185
L7 7" Cylinder \$55		R18 8"/10" w/Casters \$295
		RW8 Wide 8" w/Casters \$295
		RW10 Wide 10" w/Casters \$295

Also available w/glides.
For additional stool options see page 104.

6000 Series

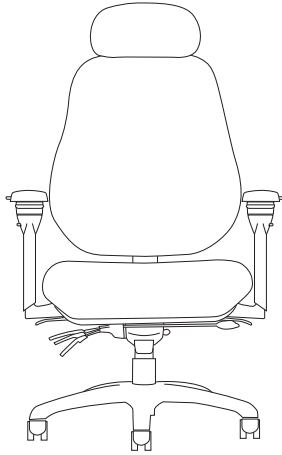

NPS6800-H4

Features

- Up to 15 active adjustments
- High back & contoured seat designs
- Passive weight dispersion design
- Generous foam for optimal comfort
- Optional headrest
- Inflatable lumbar

Standard Features

- 5-way 360° Arms
- Carpet Casters
- 26" Black Base
- 5" Cylinder
- Seat Slider

Need it Now? 5-day Quick Ship

Only standard features are available as Quick Ship unless otherwise noted.

QUICK SHIP ARMS

- 0 5-way 360°
5 No Arms

QUICK SHIP FABRICS

For available quick ship fabrics see page 10.

Step 1 — Model Number

Series Code	Back	Select a Seat	Select an Arm	Mech
NPS Neutral Posture Series	6 High Back	5 Medium Seat, Minimal Contour 6 Medium Seat, Moderate Contour 7 Medium Seat, Deep Contour 8 Large Seat, Minimal Contour 9 Large Seat, Deep Contour	0 5-way 360° \$0 3 360° w/Oversized Urethane \$75 4 Swing \$155 5 No Arms (\$140) 6 360° w/Oversized Black Vinyl \$225 7 360° w/Oversized Fabric/Leather \$265 8 Friction Tracker \$420 9 Ball Bearing Tracker \$420 P 360° Swivel \$0	0 Multi-function 
NPS	6	8	0	0



NPS6500	NPS6600	NPS6700	NPS6800	NPS6900
\$1,472	\$1,539	\$1,550	\$1,550	\$1,586
\$1,532	\$1,599	\$1,610	\$1,610	\$1,646
\$1,592	\$1,659	\$1,670	\$1,670	\$1,706
\$1,662	\$1,729	\$1,740	\$1,740	\$1,776
\$1,732	\$1,799	\$1,810	\$1,810	\$1,846
\$1,812	\$1,879	\$1,890	\$1,890	\$1,926
\$1,892	\$1,959	\$1,970	\$1,970	\$2,006
\$1,982	\$2,049	\$2,060	\$2,060	\$2,096
\$2,072	\$2,139	\$2,150	\$2,150	\$2,186

42 x 26 x 26	42 x 26 x 26	42 x 26 x 26	42 x 26 x 26	42 x 26 x 26
63 lbs	63 lbs	67.5 lbs	67.5 lbs	67.5 lbs
21	23	23	23	25
17.5 – 22.5	17.5 – 22.5	17.5 – 22.5	18.25 – 23.25	17.5 – 22.5
15 – 17.5	15 – 17.5	16 – 18.5	18 – 20.5	19.5 – 22
F3° – R11°	F9° – R6°	F10° – R3°	F5° – R7°	F8° – R6°
22.5	22.5	22.5	22.5	22.5
21.5 – 25.5	21.5 – 25.5	22 – 26	22.5 – 26.5	22 – 26
97° – 112°	98° – 113°	97° – 113°	99° – 114°	99° – 115°
4	4	4	4	4
7 – 11	7 – 11	7 – 11	6.5 – 10.5	6.5 – 10.5
15.75 – 22.25	15.75 – 22.25	18 – 22.25	18 – 22.25	18.5 – 22.25
26	26	26	26	26
2.5 yd	2.5 yd	2.5 yd	2.5 yd	2.5 yd
28 x 26 x 24	28 x 26 x 24	28 x 26 x 24	28 x 26 x 24	37 x 30 x 52
73 lbs	73 lbs	77.5 lbs	77.5 lbs	77.5 lbs
KD	KD	KD	KD	FA

- Grade 1
- Grade 2
- Grade 3
- Grade 4
- Grade 5
- Grade 6
- Grade 7
- Grade 8
- Grade 9

Upholstered Back Outer		
U1	Grade 1	\$120
U2	Grade 2	\$140
U3	Grade 3	\$160
U4	Grade 4	\$180
U5	Grade 5	\$200
U6	Grade 6	\$220
U7	Grade 7	\$240
U8	Grade 8	\$260
U9	Grade 9	\$280

- Chair (H x W x D)
- Chair Weight
- Seat Width
- Seat Height
- Seat Depth
- Seat Angle
- Back Width
- Back Height
- Back Angle
- Lumbar Range
- Arm Height
- Arm Width
- Base Diameter
- COM Yardage
- Shipping Box (L x W x H)
- Shipping Weight
- Shipping Method

All measurements are nominal and shown in inches.

Step 2 — Add option codes after model number NPS6800 - _ - _

General	Finishes	Casters/Glides	Cylinders
A Thoracic Support \$80	PT Pillow Top \$860 <i>Only available on (8) seat;</i>	C0 Carpet \$0	L1 3" Cylinder \$0
CR Cleanroom to Class 100 \$120	<i>Only in Canter, Ultraleather™ or leather</i>	C1 Hard Floor \$25	L3 5" Cylinder \$0
CX Coccyx Cutout \$215 <i>Cloud 9™, Revive™ & Top Shelf</i>	SL Stitched Leather \$350 <i>Not available on (7) & (9) seat;</i>	C2 Glides \$25	Headrest
E ESD* \$290	<i>Only in Ultraleather™ or leather</i>	C3 Occupied Braking \$185	H4 Dual Pivot \$280 <i>Matching upholstery</i>
F Fring® Footrest \$50 <i>Only available on (80) base</i>		C4 Unoccupied Braking \$60	Connexion® Arm
N N-dulgent® Memory Foam \$125		C8 Chrome Carpet \$90	Z1 Connexion Arm \$350 <i>Only available on (5) & (6) seat</i>
N2 TheraGel™ Memory Foam \$150		C9 Chrome Hard Floor \$100	Connexion® Arm Attachments
		Bases	A1 Tablet Holder \$149
		B0 26" Black \$0	
		B6 26" Polished Aluminum \$140 <i>Recommended with (L1)</i>	
		B8 27" Brushed Aluminum \$140 <i>Recommended with (L1)</i>	
		B12 28" Black \$110	

8000 Series

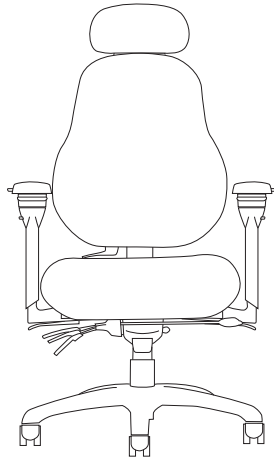

NPS8500-H4

Features

- Up to 15 active adjustments
- High back & contoured seat designs
- Passive weight dispersion design
- Generous foam for optimal comfort
- Optional headrest
- Inflatable lumbar

Standard Features

- 5-way 360° Arms
- Carpet Casters
- 26" Black Base
- 5" Cylinder
- Seat Slider

Need it Now? 5-day Quick Ship

Only standard features are available as Quick Ship unless otherwise noted.

QUICK SHIP ARMS

- 0 5-way 360°
- 5 No Arms

QUICK SHIP FABRICS

For available quick ship fabrics see page 10.

Step 1 — Model Number

Series Code	Back	Select a Seat	Select an Arm	Mech
NPS Neutral Posture Series	8 High Back	5 Medium Seat, Minimal Contour 6 Medium Seat, Moderate Contour 7 Medium Seat, Deep Contour 8 Large Seat, Minimal Contour 9 Large Seat, Deep Contour	0 5-way 360° \$0 3 360° w/Oversized Urethane \$75 4 Swing \$155 5 No Arms (\$140) 6 360° w/Oversized Black Vinyl \$225 7 360° w/Oversized Fabric/Leather \$265 8 Friction Tracker \$420 9 Ball Bearing Tracker \$420 P 360° Swivel \$0	0 Multi-function 
NPS	8	5	0	0

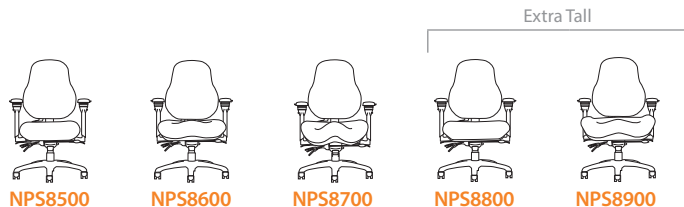

NPS8500	NPS8600	NPS8700	NPS8800	NPS8900
\$1,420	\$1,487	\$1,498	\$1,498	\$1,534
\$1,480	\$1,547	\$1,558	\$1,558	\$1,594
\$1,540	\$1,607	\$1,618	\$1,618	\$1,654
\$1,610	\$1,677	\$1,688	\$1,688	\$1,724
\$1,680	\$1,747	\$1,758	\$1,758	\$1,794
\$1,760	\$1,827	\$1,838	\$1,838	\$1,874
\$1,840	\$1,907	\$1,918	\$1,918	\$1,954
\$1,930	\$1,997	\$2,008	\$2,008	\$2,044
\$2,020	\$2,087	\$2,098	\$2,098	\$2,134

40 x 26 x 26	40 x 26 x 26	40 x 26 x 26	40 x 26 x 26	40 x 26 x 26
59.5 lbs	61 lbs	65 lbs	65 lbs	65 lbs
21	23	23	23	25
17.5 – 22.5	17.5 – 22.5	17.5 – 22.5	18.25 – 23.25	17.5 – 22.5
15.5 – 18	16 – 18.5	16 – 18.5	18 – 20.5	19 – 21.5
F3° – R11°	F9° – R6°	F10° – R3°	F5° – R7°	F8° – R6°
19.5	19.5	19.5	19.5	19.5
21.5 – 25.5	22 – 26	22 – 26	22.5 – 26.5	22 – 26
100° – 119°	100° – 115°	100° – 115°	100° – 121°	100° – 116°
4	4	4	4	4
7 – 11	7 – 11	7 – 11	6.5 – 10.5	6.5 – 10.5
15.75 – 22.25	15.75 – 22.25	18 – 22.25	18 – 22.25	18.5 – 22.25
26	26	26	26	26
2 yd	2 yd	2 yd	2 yd	2 yd
28 x 26 x 24	28 x 26 x 24	28 x 26 x 24	28 x 26 x 24	37 x 30 x 52
69.5 lbs	71 lbs	75 lbs	75 lbs	75 lbs
KD	KD	KD	KD	FA

All measurements are nominal and shown in inches. Specs may differ for stools.

- Grade 1
- Grade 2
- Grade 3
- Grade 4
- Grade 5
- Grade 6
- Grade 7
- Grade 8
- Grade 9

- Chair (H x W x D)
- Chair Weight
- Seat Width
- Seat Height
- Seat Depth
- Seat Angle
- Back Width
- Back Height
- Back Angle
- Lumbar Range
- Arm Height
- Arm Width
- Base Diameter
- COM Yardage
- Shipping Box (L x W x H)
- Shipping Weight
- Shipping Method

Upholstered Back Outer		
U1	Grade 1	\$120
U2	Grade 2	\$140
U3	Grade 3	\$160
U4	Grade 4	\$180
U5	Grade 5	\$200
U6	Grade 6	\$220
U7	Grade 7	\$240
U8	Grade 8	\$260
U9	Grade 9	\$280

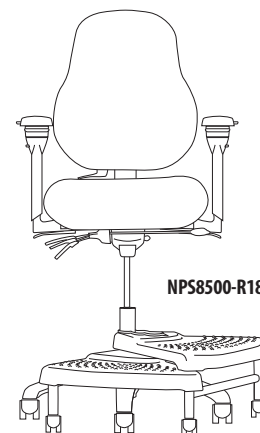

Step 2 — Add option codes after model number NPS8500 - __ - __

General	Casters/Glides	Cylinders
A Thoracic Support \$80	C0 Carpet \$0	L1 3" Cylinder \$0
CR Cleanroom to Class 100 \$120	C1 Hard Floor \$25	L3 5" Cylinder \$0
CX Coccyx Cutout \$215 <i>Cloud 9™, Revive™ & Top Shelf</i>	C2 Glides \$25	Headrest
D1 No Inflatable Lumbar (\$50)	C3 Occupied Braking \$185	H4 Dual Pivot \$280 <i>Matching upholstery</i>
E ESD* \$290	C4 Unoccupied Braking \$60	Connexion® Arm
F Fring® Footrest \$50 <i>Only available on (B0) base</i>	C8 Chrome Carpet \$90	Z1 Connexion Arm \$350 <i>Only available on (5) & (6) seat</i>
N N-dulgent® Memory Foam \$125	C9 Chrome Hard Floor \$100	Connexion® Arm Attachments
N2 TheraGel™ Memory Foam \$150	Bases	A1 Tablet Holder \$149
Finishes	B0 26" Black \$0	
SL Stitched Leather \$350 <i>Not available on (7) or (9) seat; Only in UltraLeather™ or leather</i>	B6 26" Polished Aluminum \$140 <i>Recommended with (L1)</i>	
	B8 27" Brushed Aluminum \$140 <i>Recommended with (L1)</i>	
	B12 28" Black \$110	

Stool Options

Stool Cylinders	Footrings for stool cylinders only	NeXtep® for stool cylinders only
L4 8" Cylinder \$55	R1 18" Black Plastic \$60	R8 8" w/Casters \$185
L5 10" Cylinder \$55	R2 20" Chrome \$80	R10 10" w/Casters \$185
L7 7" Cylinder \$55		R18 8"/10" w/Casters \$295
		RW8 Wide 8" w/Casters \$295
		RW10 Wide 10" w/Casters \$295

Also available w/glides.

For additional stool options see page 104.

Big & Tall

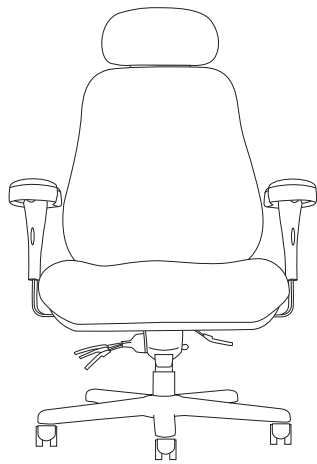

BTC10100-H4



BTC16800
Extra Tall

Features

- Up to 11 active adjustments
- High back & contoured seat designs
- 24/7 Continuous-shift w/5-year warranty
- Available in both regular & junior sizes
- Supports users up to 500 lbs and/or 7 ft tall
- Optional headrest
- Optional leather pillow top
- Inflatable lumbar

Standard Features

- Oversized Padded Arms
- Carpet Casters
- 28" Intensive Use Black Base
- 5" Cylinder
- Seat Slider

Need it Now? 5-day Quick Ship

Only standard features are available as Quick Ship unless otherwise noted.

QUICK SHIP ARMS

- 0 5-way 360°
- 5 No Arms

QUICK SHIP FABRICS

For available quick ship fabrics see page 10.

Step 1 — Model Number

Series Code	Select a Back	Select a Seat	Select an Arm	Mech
BTC Big & Tall	16 High Back 10 Extra Large Back	1 Extra Large, Minimal Contour 8 Large Seat, Minimal Contour 9 Large Seat, Deep Contour	0 Oversized Padded \$0 1 Urethane Arm Pads (\$50)	0 Multi-function 
BTC	10	1	0	0



Regular	Junior (Extra Tall)	
BTC10100	BTC16800	BTC16900
\$2,236	\$2,236	\$2,272
\$2,296	\$2,296	\$2,332
\$2,356	\$2,356	\$2,392
\$2,426	\$2,426	\$2,462
\$2,496	\$2,496	\$2,532
\$2,576	\$2,576	\$2,612
\$2,656	\$2,656	\$2,692
\$2,746	\$2,746	\$2,782
\$2,836	\$2,836	\$2,872

42 x 35 x 28	41 x 31 x 28	41 x 31 x 28
85 lbs	76 lbs	76 lbs
27	23	25
20 – 25	19 – 24	19 – 24
20 – 22	19 – 21	20 – 22
F1° – R7.5°	F4° – R12°	F1° – R9°
24	22.5	22.5
22 – 26	22 – 26	24 – 28
96° – 118°	95° – 112°	97° – 115°
4	4	4
7 – 10	7 – 10	7 – 10
24	21	24
28	28	28
2.5 yd	2.5 yd	2.5 yd
37 x 30 x 52	37 x 30 x 52	37 x 30 x 52
105 lbs	96 lbs	96 lbs
FA	FA	FA

All measurements are nominal and shown in inches.

- Grade 1
- Grade 2
- Grade 3
- Grade 4
- Grade 5
- Grade 6
- Grade 7
- Grade 8
- Grade 9

- Chair (H x W x D)
- Chair Weight
- Seat Width
- Seat Height
- Seat Depth
- Seat Angle
- Back Width
- Back Height
- Back Angle
- Lumbar Range
- Arm Height
- Arm Width
- Base Diameter
- COM Yardage
- Shipping Box (L x W x H)
- Shipping Weight
- Shipping Method

Upholstered Back Outer		
U1	Grade 1	\$120
U2	Grade 2	\$140
U3	Grade 3	\$160
U4	Grade 4	\$180
U5	Grade 5	\$200
U6	Grade 6	\$220
U7	Grade 7	\$240
U8	Grade 8	\$260
U9	Grade 9	\$280

Step 2 — Add option codes after model number BTC10100 - ___ - ___

General		Finishes		Bases		Headrest					
A	Thoracic Support	\$80	PT	Pillow Top	\$1,000	B9	28" Chrome	\$160	H4	Dual Pivot	\$280
CR	Cleanroom to Class 100	\$120				B14	28" Intensive Use Black	\$0			<i>Matching upholstery</i>
CX	Coccyx Cutout	\$215				Cylinders					
	<i>Cloud 9™, Revive™ & Top Shelf</i>					L1	3" Cylinder	\$0			
E	ESD*	\$290				L3	5" Cylinder	\$0			
J	Upholstered Arm Pad	\$65				Casters/Glides					
	<i>Only available on (0) arm</i>		C0	Carpet	\$0						
N	N-dulgent® Memory Foam	\$125	C1	Hard Floor	\$25						
N2	TheraGel™ Memory Foam	\$150	C2	Glides	\$25						

XSM™
Extra Small

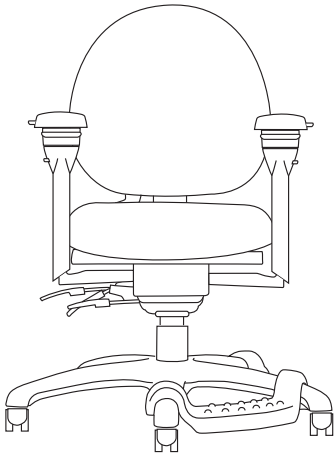

XSM5300-F

Features

- Up to 12 active adjustments
- Petite seat
- Mesh back, mid back or high back
- Passive weight dispersion design
- Generous foam for optimal comfort
- Optional headrest available on 1 & 8 back

Standard Features

- 5-way 360° Arms
- Carpet Casters
- 26" Black Base
- 5" Cylinder
- Seat Slider

Need it Now? 5-day Quick Ship

Only standard features are available as Quick Ship unless otherwise noted.

QUICK SHIP ARMS

- 0 5-way 360°
- 5 No Arms

QUICK SHIP FABRICS

For available quick ship fabrics see page 10.

Step 1 — Model Number

Series Code	Select a Back	Select a Seat	Select an Arm	Mech
XSM Extra Small Series	<ul style="list-style-type: none"> 1 Mesh Back 5 Mid Back 8 High Back 	<ul style="list-style-type: none"> 3 Petite Seat, Minimal Contour 	<ul style="list-style-type: none"> 0 5-way 360° \$0 3 360° w/Oversized Urethane \$75 5 No Arms (\$140) 6 360° w/Oversized Black Vinyl \$225 7 360° w/Oversized Fabric/Leather \$265 P 360° Swivel \$0 	<ul style="list-style-type: none"> 0 Multi-function 
XSM	5	5	0	0



XSM1300



XSM5300



XSM8300

\$1,305	\$1,352	\$1,487
\$1,365	\$1,412	\$1,547
\$1,425	\$1,472	\$1,607
\$1,495	\$1,542	\$1,677
\$1,565	\$1,612	\$1,747
\$1,645	\$1,692	\$1,827
\$1,725	\$1,772	\$1,907
\$1,815	\$1,862	\$1,997
\$1,905	\$1,952	\$2,087

- Grade 1**
- Grade 2**
- Grade 3**
- Grade 4**
- Grade 5**
- Grade 6**
- Grade 7**
- Grade 8**
- Grade 9**

39.75 x 26 x 26	35.5 x 26 x 26	40.25 x 26 x 26
52.5 lbs	52 lbs	54.5 lbs
17	17	17
15.75 – 20.75	15.75 – 20.75	15.75 – 20.75
15.5 – 18	15.5 – 18	15.5 – 18
F4° – R11°	F4° – R11°	F6° – R12°
19	17.5	19.5
23	18 – 22	23 – 27
95° – 115°	105° – 121°	95° – 111°
3	4	4
7 – 11	7 – 11	7 – 11
13.5 – 18.25	13.5 – 18.25	13.5 – 18.25
26	26	26
1 yd	2 yd	2 yd
28 x 26 x 24	28 x 26 x 24	28 x 26 x 24
62.5 lbs	62 lbs	64.5 lbs
KD	KD	KD

- Chair (H x W x D)
- Chair Weight
- Seat Width
- Seat Height
- Seat Depth
- Seat Angle
- Back Width
- Back Height
- Back Angle
- Lumbar Range
- Arm Height
- Arm Width
- Base Diameter
- COM Yardage
- Shipping Box (L x W x H)
- Shipping Weight
- Shipping Method

All measurements are nominal and shown in inches. Specs may differ for stools.

Upholstered Back Outer		
U1	Grade 1	\$120
U2	Grade 2	\$140
U3	Grade 3	\$160
U4	Grade 4	\$180
U5	Grade 5	\$200
U6	Grade 6	\$220
U7	Grade 7	\$240
U8	Grade 8	\$260
U9	Grade 9	\$280

Only available on 5 and 8 backs.

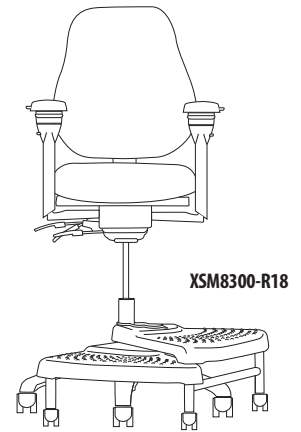

XSM8300-R18

Step 2 — Add option codes after model number XSM5300 - ___ - ___

General

A	Thoracic Support	\$80
	<i>Not available on (1) back</i>	
CR	Cleanroom to Class 100	\$120
CX	Coccyx Cutout	\$215
	<i>Cloud 9™, Revive™ & Top Shelf</i>	
D1	No Inflatable Lumbar	(\$50)
E	ESD*	\$290
F	Fring® Footrest	\$50
	<i>Only available on (B0) base</i>	
N	N-dulgent® Memory Foam	\$125
N2	TheraGel™ Memory Foam	\$150

Back Sleeve – only available on (1) back

S1	Grade 1	\$95
S2	Grade 2	\$135
S5	Ultraleather™	\$250
Casters/Glides		
C0	Carpet	\$0
C1	Hard Floor	\$25
C2	Glides	\$25
C3	Occupied Braking	\$185
C4	Unoccupied Braking	\$60
C8	Chrome Carpet	\$90
C9	Chrome Hard Floor	\$100

Bases

B0	26" Black	\$0
B6	26" Polished Aluminum	\$140
	<i>Recommended with (L1)</i>	
B8	27" Brushed Aluminum	\$140
	<i>Recommended with (L1)</i>	
B12	28" Black	\$110
Chair Cylinders		
L1	3" Cylinder	\$0
L3	5" Cylinder	\$0
Headrest		
HE	Height Adjustable	\$60
	<i>Black vinyl – (1) back only</i>	
H4	Dual Pivot	\$280
	<i>Matching upholstery (8) back only</i>	
H5	Dual Pivot	\$280
	<i>Black faux leather (1) back only</i>	

Stool Options

Stool Cylinders

L4	8" Cylinder	\$55
L5	10" Cylinder	\$55
L7	7" Cylinder	\$55

Footrings for stool cylinders only

R1	18" Black Plastic	\$60
R2	20" Chrome	\$80

NeXtep® for stool cylinders only

R8	8" w/Casters	\$185
R10	10" w/Casters	\$185
R18	8"/10" w/Casters	\$295
RW8	Wide 8" w/Casters	\$295
RW10	Wide 10" w/Casters	\$295

Also available w/glides.

For additional stool options see page 104.

TASK/CONFERENCE SEATING

Neutral Posture's task/conference seating offers a wide range of styles, features and options to address any application needs. The task/conference seating was designed with elegance and engineered with functionality and health promoting benefits in mind. The task/conference seating is also a very extensive category, providing anything from highly ergonomic chairs for personal use to stools and guest chairs for shorter periods of seated time and unique tasks. The multitude of specialty armrests and fabric types available, will ensure that you have the chair needed to complete the task at hand and

look good while doing it. In our task/conference seating we have many different families of chairs, allowing you to fill your space with multi-functional chairs having a common theme and look. We offer many of our task/conference chairs in mesh making the chair more breathable for comfort, as well as offering a customizable sleeve that you can slide over the mesh back for an upholstered look and feel. Whether you are in the market to find an ergonomic chair to boost comfort and productivity or a family of chairs to spice up the office. Our task/conference seating has the exact chair to fit your wants and needs.

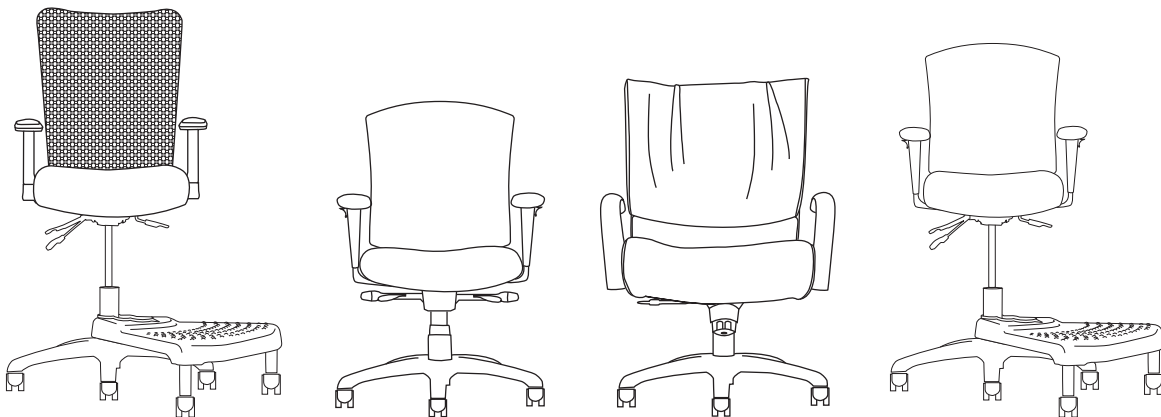

TASK/CONFERENCE SEATING

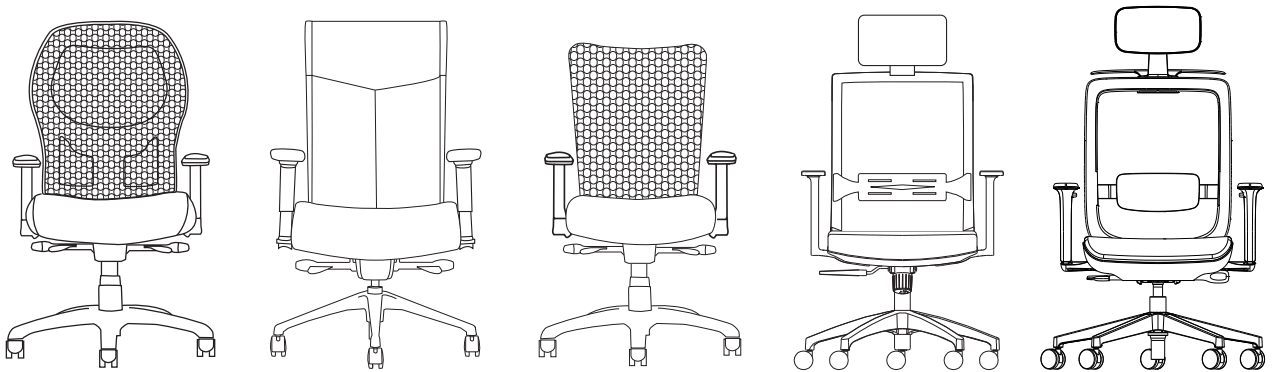

Arm Options

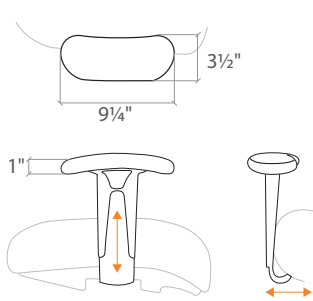

0 – 4" ADJUSTABLE

Arm Height 7.0 – 11.0
 Arm Width 17.5 – 21.5
 Arm Pivot fixed
 Weight 7 lbs

Mesh Seat
 Arm Height 9.0 – 13.0

Available on

Balance U4ia
 Cozi
 Cozi 24/7
 E-Series

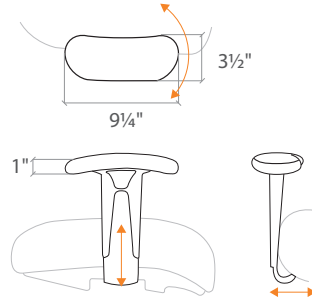

1 – 4" ADJ. W/PIVOT

Arm Height 7.0 – 11.0
 Arm width 17.5 – 21.5
 Arm Pivot 25° range
 Weight 7 lbs

Mesh Seat
 Arm Height 9.0 – 13.0

Available on

Balance
 Cozi
 U4ia

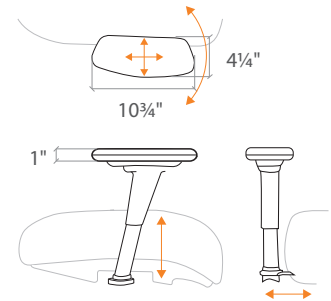

2 – LATERAL SLIDING

Arm Height 7.0 – 11.0
 Arm Width 17.5 – 21.5
 Arm Pivot 30° range
 Weight 7 lbs

Mesh Seat
 Arm Height 9.0 – 13.0

Available on

Cozi NV Guest
 E-Series U4ia
 Right Chair
 NV

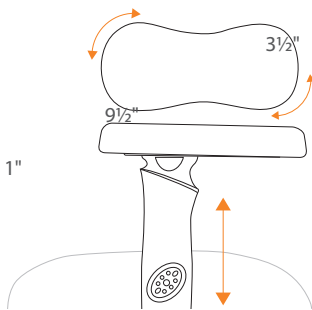

3 – 3" ADJUSTABLE

Arm Height 7.5 – 11.0
 Arm Width: 18 – 24
 Arm Pivot fixed
 Weight 6 lbs

Mesh Seat
 Arm Height 9.5 – 13.0

Available on

Cozi U4ia
 Cozi Guest U4ia Guest
 Right Chair
 Right Chair Guest

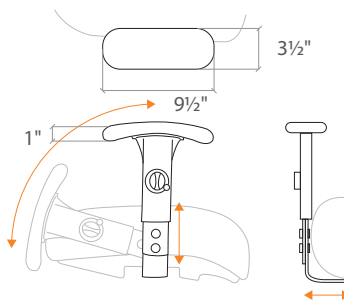

4 – SWING

Arm Height 7.0 – 10.0
 Arm Width 17.75 – 22
 Arm Pivot fixed
 Weight 7 lbs

Mesh Seat
 Arm Height 9.0 – 12.0

Available on

Cozi
 Cozi 24/7
 U4ia

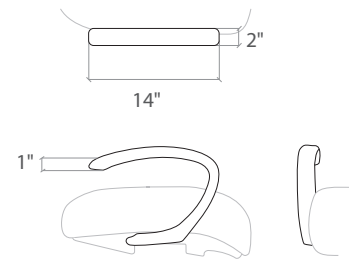

6 – C LOOP

Arm Height 7.5
 Arm Width 22.5
 Arm Pivot fixed
 Weight 5 lbs

Mesh Seat
 Arm Height 9.5

Available on

Balance Embrace Guest
 Cozi Right Chair Guest
 Cozi Guest U4ia
 Embrace U4ia Guest

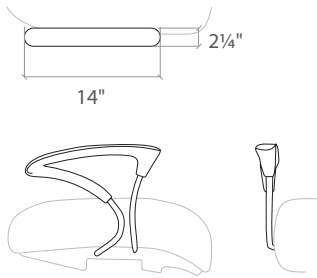

7 - CHROME LOOP

Arm Height 7.5
 Arm Width 22.25
 Arm Pivot fixed
 Weight 5 lbs

Mesh Seat
 Arm Height 9.5

Available on

Balance	Right Chair Guest
Cozi	U4ia
Cozi Guest	U4ia Guest
NV Guest	

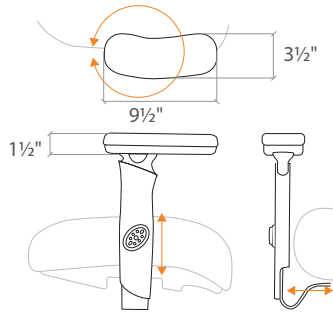

8 - 360° NP

Arm Height 7.0 - 11.0
 Arm Width 18 - 22
 Arm Pivot 360° range
 Weight 7 lbs

Mesh Seat
 Arm Height 9.0 - 13.0

Available on

Cozi
 Right Chair
 U4ia

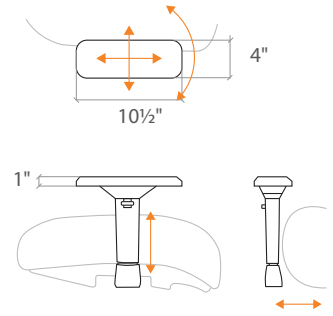

9 - 5-WAY ADJUSTABLE

Arm Height 7.0 - 10.0
 Arm Width 16.5 - 23.5
 Arm Pivot 15° range
 Weight 6 lbs

Mesh Seat
 Arm Height 9.0 - 12.0

Available on

Cozi
 E-Series
 Right Chair
 U4ia

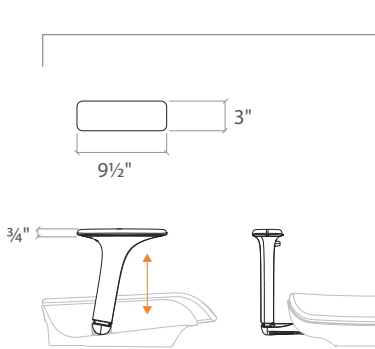

0 - 1D

Arm Height 7 - 10.5
 Arm Width 19.5
 Arm Pivot fixed
 Weight 4.5 lbs

Available on

Icon

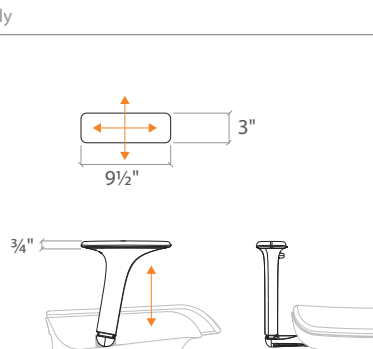

3 - 3D

Arm Height 7 - 10.5
 Arm Width 18 - 20
 Arm Pivot fixed
 Weight 4.5 lbs

Available on

Icon

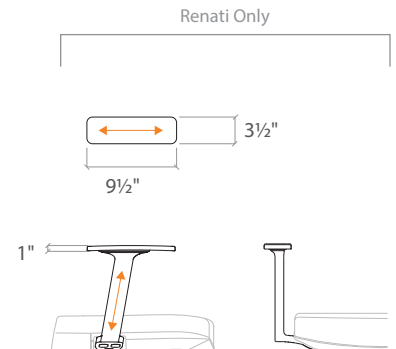

0 - ADJUSTABLE

Arm Height 7 - 11
 Arm Width 18.5 - 19.5
 Arm Pivot fixed
 Weight 4 lbs

Available on

Renati

All measurements shown are in inches.

CHAIR MECHANISMS

Task/Conference



0 – KNEE-TILT

- Swivel 360°
- Pneumatic seat height
- Seat tilt tension
- Back to seat tilt, 1:1
- Rock or lock recline

Available on

Balance
Embrace
U4ia



2 – SYNCHRO

- Swivel 360°
- Pneumatic seat height
- Seat tilt tension
- Back angle
- Seat angle
- Back to seat tilt, 2:1
- Anti-kick tilt-lock
- Optional seat slider

Available on

Balance
Cozi
NV
Right Chair
U4ia

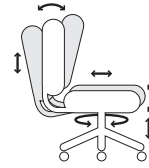

3 – WEIGHT SENSITIVE

- Swivel 360°
- Pneumatic seat height
- Seat tilt tension
- Back angle
- Seat angle
- Back to seat tilt, 2:1
- Anti-kick tilt-lock
- Seat slider

Available on

Icon



4 – TILT-SWIVEL

- Swivel 360°
- Pneumatic seat height
- Seat tilt tension
- Back to seat tilt, 1:1

Available on

Embrace
Renati



6 – MULTI-TILT

- Swivel 360°
- Pneumatic seat height
- Independent back angle
- Independent seat angle
- Seat tilt tension
- Infinite adjust forward tilt-stop
- Optional seat slider

Available on

Cozi
E-Series
Right Chair

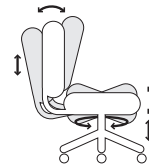

8 – MULTI-TILT

- Swivel 360°
- Pneumatic seat height
- Independent back angle
- Independent seat angle
- Seat tilt tension
- Infinite adjust forward tilt-stop
- Seat slider

Available on

Cozi 24/7
Cozi 400

STOOL MECHANISMS

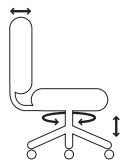

1 – BASIC

- Swivel 360°
- Pneumatic seat height
- Back depth

Available on

Cozi Stool
Right Chair Stool
U4ia Stool

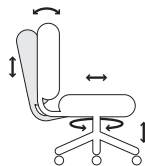

8 – STANDARD

- Swivel 360°
- Pneumatic seat height
- Seat slider
- Independent back angle

Available on

Cozi Stool
Right Chair Stool
U4ia Stool

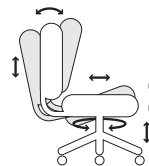

9 – DELUXE-TILT

- Swivel 360°
- Pneumatic seat height
- Seat slider
- Seat angle
- Independent back angle

Available on

Cozi Stool
Right Chair Stool
U4ia Stool

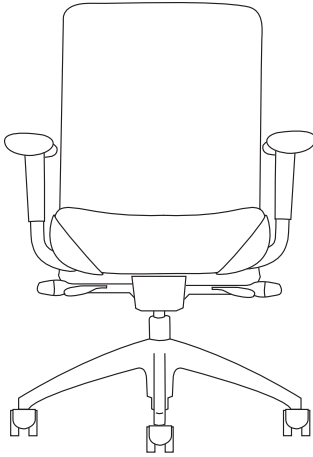

BAL5302



Features

- Up to 11 active adjustments
- Mesh or upholstered back
- Passive weight dispersion design
- Generous foam for optimal comfort

Standard Options

- No Arms
- Carpet Casters
- 26" High Crown Black Base
- 5" Cylinder

Step 1 — Model Number

Series Code	Back	Seat	Select an Arm	Select a Mech
BAL Balance	5 High Back	3 Large Seat	0 Pivoting Gelthane \$125 1 Forward Sliding Gelthane Pad \$205 5 No Arms \$0 6 C Loop \$75 7 Chrome Loop \$75	0 Knee-tilt  2 Synchro 
BAL	5	3	0	2

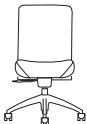
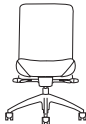
Knee-tilt	Synchro
	
BAL5350	BAL5352
\$1,014	\$1,092
\$1,074	\$1,152
\$1,134	\$1,212
\$1,204	\$1,282
\$1,274	\$1,352
\$1,354	\$1,432
\$1,434	\$1,512
\$1,524	\$1,602
\$1,614	\$1,692

38 x 26 x 26	39 x 26 x 26	Chair (H x W x D)
48.5 lbs	39 lbs	Chair Weight
22	22	Seat Width
16.5 – 21.5	16.5 – 21.5	Seat Height
17.5	16.5 – 19.5	Seat Depth (OPTIONAL)
F6° – R15°	F5° – R12°	Seat Angle
18.5	18.5	Back Width
22	22	Back Height
105° – 125°	102° – 125°	Back Angle
N/A	N/A	Lumbar Range
26	26	Base Diameter
2 yd	2 yd	COM Yardage
26 x 22 x 34	26 x 22 x 34	Shipping Box (L x W x H)
58.5 lbs	49 lbs	Shipping Weight
KD	KD	Shipping Method

All measurements are nominal and shown in inches.
All upholstery subject to Neutral Posture approval.

Step 2 — Add option codes after model number BAL5302-__-__

General		Finishes		Bases		Casters/Glides					
N	N-dulgent® Memory Foam <i>Seat only</i>	\$75	U2	Mesh Back	\$0	B0	26" Black	\$0	C0	Carpet	\$0
N2	TheraGel™ Memory Foam <i>Seat only</i>	\$150				B6	26" Polished Aluminum	\$140	C1	Hard Floor	\$25
S	Seat Slider <i>Only available on (2) mech</i>	\$75				B15	26" High Crown Polished Aluminum	\$55	C2	Glides	\$25
						B16	26" High Crown Black	\$0	C8	Chrome Carpet	\$90
									C9	Chrome Hard Floor	\$100

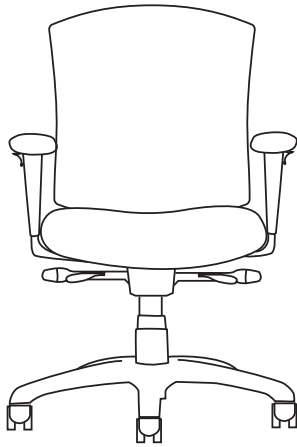

COZ5602

Task/Conference

Guardian® Option

The Guardian is an NIJ Level II compliant bullet resistant vest that will provide protection against regular powered 9mm handguns, up to .357 Magnums. The vest fits over the back of the chair and is easily removable.

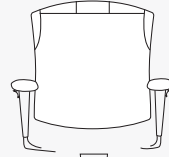

Guardian – Bullet Resistant Vest

G Guardian \$1,960
Center or Ballistic Only

Features

- Up to 13 active adjustments
- Standard with upholstered back outer
- Passive weight dispersion design
- Generous foam for optimal comfort
- Optional headrest

Standard Features

- No Arms
- Carpet Casters
- 26" Black Base
- 5" Cylinder

Need it Now? 5-day Quick Ship

Only standard features are available as Quick Ship unless otherwise noted.



QUICK SHIP ARMS

- 3 3" Adjustable Arms
- 5 No Arms
- 9 5-way Adjustable Arms

QUICK SHIP FABRICS

For available quick ship fabrics see page 10.

Step 1 — Model Number

Series Code	Select a Back	Select a Seat	Select an Arm	Select a Mech
COZ Cozi	<ul style="list-style-type: none"> 5 Mid Back 6 High Back 	<ul style="list-style-type: none"> 6 Medium Seat 7 Large Seat 	<ul style="list-style-type: none"> 0 4" Adjustable \$125 1 4" Adjustable w/Pivot \$150 2 Lateral Sliding \$140 3 3" Adjustable \$75 4 Swing \$295 5 No Arms \$0 6 C Loop \$75 7 Chrome Loop \$75 9 5-way Adjustable \$150 	<ul style="list-style-type: none"> 2 Synchro  6 Multi-tilt 
COZ	5	6	3	6

Synchro				Multi-tilt				
COZ5652	COZ5752	COZ6652	COZ6752	COZ5656	COZ5756	COZ6656	COZ6756	
\$811	\$862	\$913	\$964	\$887	\$938	\$989	\$1,040	Grade 1
\$871	\$922	\$973	\$1,024	\$947	\$998	\$1,049	\$1,100	Grade 2
\$931	\$982	\$1,033	\$1,084	\$1,007	\$1,058	\$1,109	\$1,160	Grade 3
\$1,001	\$1,052	\$1,103	\$1,154	\$1,077	\$1,128	\$1,179	\$1,230	Grade 4
\$1,071	\$1,122	\$1,173	\$1,224	\$1,147	\$1,198	\$1,249	\$1,300	Grade 5
\$1,151	\$1,202	\$1,253	\$1,304	\$1,227	\$1,278	\$1,329	\$1,380	Grade 6
\$1,231	\$1,282	\$1,333	\$1,384	\$1,307	\$1,358	\$1,409	\$1,460	Grade 7
\$1,321	\$1,372	\$1,423	\$1,474	\$1,397	\$1,448	\$1,499	\$1,550	Grade 8
\$1,411	\$1,462	\$1,513	\$1,564	\$1,487	\$1,538	\$1,589	\$1,640	Grade 9
39 x 26 x 26	39 x 26 x 26	43.5 x 26 x 26	43.5 x 26 x 26	39 x 26 x 26	39 x 26 x 26	43.5 x 26 x 26	43.5 x 26 x 26	Chair (H x W x D)
47 lbs	47 lbs	47 lbs	47 lbs	51 lbs	51 lbs	51 lbs	51 lbs	Chair Weight
19.5	22	19.5	22	19.5	22	19.5	22	Seat Width
16.5 – 21.5	16.5 – 21.5	16.5 – 21.5	16.5 – 21.5	16.5 – 21.5	16.5 – 21.5	16.5 – 21.5	16.5 – 21.5	Seat Height
16.5 – 19.5	16.5 – 19.5	16.5 – 19.5	16.5 – 19.5	16.5 – 19	16.5 – 19	16.5 – 19	16.5 – 19	Seat Depth (OPTIONAL)
F6° – R13°	F6° – R13°	F6° – R13°	F6° – R13°	F6° – R16°	F8° – R18°	F6° – R16°	F8° – R18°	Seat Angle
19	19	19	19	19	19	19	19	Back Width
21 – 24	21 – 24	26 – 29	26 – 29	22 – 25	22 – 25	24 – 27	24 – 27	Back Height
107° – 128°	107° – 128°	107° – 128°	107° – 128°	102° – 122°	102° – 122°	103° – 120°	103° – 120°	Back Angle
3	3	3	3	3	3	3	3	Lumbar Range
26	26	26	26	26	26	26	26	Base Diameter
2 yd	2 yd	2 yd	2 yd	2 yd	2 yd	2 yd	2 yd	COM Yardage
36 x 26 x 19	36 x 26 x 19	36 x 26 x 19	36 x 26 x 19	36 x 26 x 19	36 x 26 x 19	36 x 26 x 19	36 x 26 x 19	Shipping Box (L x W x H)
57 lbs	57 lbs	57 lbs	57 lbs	61 lbs	61 lbs	61 lbs	61 lbs	Shipping Weight
KD	KD	KD	KD	KD	KD	KD	KD	Shipping Method

All measurements are nominal and shown in inches.

Step 2 — Add option codes after model number COZ5636 - _ - _

General	Casters/Glides	Cylinders	Connexion® Arm
CR Cleanroom to Class 100 \$120	C0 Carpet \$0	L1 3" Cylinder \$0	Z1 Connexion Arm \$350
D2 Adjustable Lumbar Support \$100	C1 Hard Floor \$25	L3 5" Cylinder \$0	<i>Not available with (6) & (7) arm</i>
E ESD* \$290	C2 Glides \$25	Headrest	Connexion® Arm Attachments
F Fring® Footrest \$50	C3 Occupied Braking \$185	H6 Dual Pivot \$280	A1 Tablet Holder \$149
<i>Only available on (B0) base</i>	C4 Unoccupied Braking \$60	<i>Matching upholstery</i>	
N N-dulgent® Memory Foam \$125	Bases		
N2 TheraGel™ Memory Foam \$150	B0 26" Black \$0		
S Seat Slider \$75	B6 26" Polished Aluminum \$140		
	B7 26" Black Aluminum \$100		

Cozi® Stool

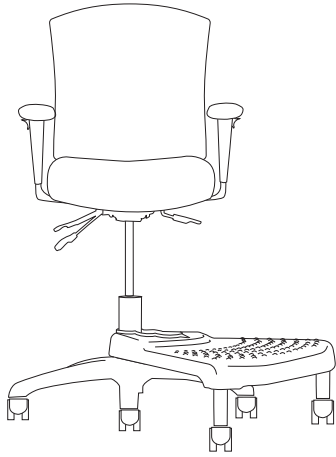

COZ5638-R8

Task/Conference

Guardian® Option

The Guardian is an NIJ Level II compliant bullet resistant vest that will provide protection against regular powered 9mm handguns, up to .357 Magnums. The vest fits over the back of the chair and is easily removable.

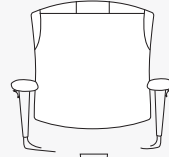

Guardian – Bullet Resistant Vest

G Guardian \$1,960
Center or Ballistic Only

Features

- Up to 13 active adjustments
- Standard with upholstered back outer
- Passive weight dispersion design
- Generous foam for optimal comfort
- Optional headrest

Standard Features

- No Arms
- Carpet Casters
- 26" Black Base
- 8" Cylinder

Need it Now? 5-day Quick Ship

Only standard features are available as Quick Ship unless otherwise noted.

QUICK SHIP ARMS







- 3 3" Adjustable Arms
- 5 No Arms
- 9 5-way Adjustable Arms

QUICK SHIP FABRICS

For available quick ship fabrics see page 10

Step 1 — Model Number

Series Code	Back	Select a Seat	Select an Arm	Select a Mech
COZ Cozi	5 Mid Back	6 Medium Seat 7 Large Seat	0 4" Adjustable \$125 1 4" Adjustable w/Pivot \$150 2 Lateral Sliding \$140 3 3" Adjustable \$75 4 Swing \$295 5 No Arms \$0 6 C Loop \$75 7 Chrome Loop \$75 9 5-way Adjustable \$150	1 Basic 8 Standard 9 Deluxe-tilt
COZ	5	6	3	8

Basic		Standard		Deluxe-tilt	
					
COZ5651	COZ5751	COZ5658	COZ5758	COZ5659	COZ5759
\$826	\$877	\$847	\$898	\$867	\$918
\$886	\$937	\$907	\$958	\$927	\$978
\$946	\$997	\$967	\$1,018	\$987	\$1,038
\$1,016	\$1,067	\$1,037	\$1,088	\$1,057	\$1,108
\$1,086	\$1,137	\$1,107	\$1,158	\$1,127	\$1,178
\$1,166	\$1,217	\$1,187	\$1,238	\$1,207	\$1,258
\$1,246	\$1,297	\$1,267	\$1,318	\$1,287	\$1,338
\$1,336	\$1,387	\$1,357	\$1,408	\$1,377	\$1,428
\$1,426	\$1,477	\$1,447	\$1,498	\$1,467	\$1,518
43 x 26 x 26	43 x 26 x 26	43.5 x 26 x 26	43.5 x 26 x 26	43.5 x 26 x 26	43.5 x 26 x 26
34 lbs	34 lbs	46 lbs	46 lbs	46 lbs	46 lbs
19.5	22	19.5	22	19.5	22
20.5 – 28.5	20.5 – 28.5	22 – 30	22 – 30	22 – 30	22 – 30
16.5 – 18.5	16.5 – 18.5	16.5 – 19	16.5 – 19	16.5 – 19	16.5 – 19
R4°	R4°	R3°	R3°	R4°	R4°
19	19	19	19	19	19
21.5 – 24	21.5 – 24	22 – 25	22 – 25	22 – 25	22 – 25
103°	103°	95° – 102°	95° – 102°	97° – 105°	97° – 105°
3	3	3	3	3	3
26	26	26	26	26	26
2 yd	2 yd	2 yd	2 yd	2 yd	2 yd
36 x 26 x 19	36 x 26 x 19	36 x 26 x 19	36 x 26 x 19	36 x 26 x 19	36 x 26 x 19
44 lbs	44 lbs	56 lbs	56 lbs	56 lbs	56 lbs
KD	KD	KD	KD	KD	KD

- Grade 1**
- Grade 2**
- Grade 3**
- Grade 4**
- Grade 5**
- Grade 6**
- Grade 7**
- Grade 8**
- Grade 9**

- Chair (H x W x D)
- Chair Weight
- Seat Width
- Seat Height
- Seat Depth (OPTIONAL)
- Seat Angle
- Back Width
- Back Height
- Back Angle
- Lumbar Range
- Base Diameter
- COM Yardage
- Shipping Box (L x W x H)
- Shipping Weight
- Shipping Method

All measurements are nominal and shown in inches.

Step 2 — Add option codes after model number COZ5638 - _ - _

General CR Cleanroom to Class 100 \$120 D2 Adjustable Lumbar Support \$100 E ESD* \$290 N N-dulgent® Memory Foam \$125 N2 TheraGel™ Memory Foam \$150 Casters/Glides C0 Carpet \$0 C1 Hard Floor \$25 C2 Glides \$25 C3 Occupied Braking \$185 C4 Unoccupied Braking \$60	Bases B0 26" Black \$0 B6 26" Polished Aluminum \$140 B7 26" Black Aluminum \$100 Chair Cylinders L1 3" Cylinder \$0 L3 5" Cylinder \$0 Headrest H4 Dual Pivot \$280 <i>Matching upholstery</i>	Connexion® Arm Z1 Connexion Arm \$350 <i>Not available with (6) & (7) arm</i> Connexion® Arm Attachments A1 Tablet Holder \$149	Stool Cylinders L4 8" Cylinder \$0 L5 10" Cylinder \$0 L7 7" Cylinder \$0 Footrings for stool cylinders only R1 18" Black Plastic \$60 R2 20" Chrome \$80 NeXtep® for stool cylinders only R8 8" w/Casters \$185 R10 10" w/Casters \$185 R18 8"/10" w/Casters \$295 RW8 Wide 8" w/Casters \$295 RW10 Wide 10" w/Casters \$295
--	---	---	--

Also available w/glides.

For additional stool options see page 104.

Cozi® 24/7

Formally N-dure & N-dure 400

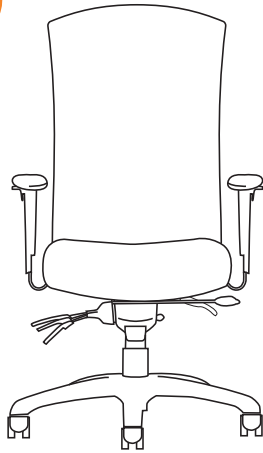

COZ5608

Task/Conference

Guardian® Option

The Guardian is an NIJ Level II compliant bullet resistant vest that will provide protection against regular powered 9mm handguns, up to .357 Magnums. The vest fits over the back of the chair and is easily removable.

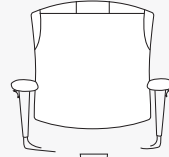

Guardian – Bullet Resistant Vest

G Guardian \$1,960
Center or Ballistic Only

Features

- Up to 11 active adjustments
- Standard with upholstered back outer
- 24/7 Continuous-shift with 5-year warranty available only on upholstery with a double rub rating of over 1,000,000
- Passive weight dispersion design
- Generous foam for optimal comfort
- Optional headrest

Standard Features

- No Arms
- Carpet Casters
- 26" Black Base
- 5" Cylinder Intensive Use
- Seat Slider

Step 1 — Model Number

Series Code	Select a Back	Select a Seat	Select an Arm	Mech
CZN Cozi	5 Mid Back 6 High Back	6 Medium Seat 7 Large Seat 8 Extra Large Seat <i>Supports up to 400 lbs</i>	0 4" Adjustable \$125 4 Swing \$295 5 No Arms \$0	8 Multi-tilt 
CZN	5	6	0	8

Supports upto 350 lbs

Supports upto 400 lbs

Model	CZN5658	CZN5758	CZN6658	CZN6758	CZN5858	CZN6858
Grade 1	\$1,076	\$1,112	\$1,163	\$1,188	\$1,341	\$1,418
Grade 2	\$1,136	\$1,172	\$1,223	\$1,248	\$1,401	\$1,478
Grade 3	\$1,196	\$1,232	\$1,283	\$1,308	\$1,461	\$1,538
Grade 4	\$1,266	\$1,302	\$1,353	\$1,378	\$1,531	\$1,608
Grade 5	\$1,336	\$1,372	\$1,423	\$1,448	\$1,601	\$1,678
Grade 6	\$1,416	\$1,452	\$1,503	\$1,528	\$1,681	\$1,758
Grade 7	\$1,496	\$1,532	\$1,583	\$1,608	\$1,761	\$1,838
Grade 8	\$1,586	\$1,622	\$1,673	\$1,698	\$1,851	\$1,928
Grade 9	\$1,676	\$1,712	\$1,763	\$1,788	\$1,941	\$2,018

Model	CZN5658	CZN5758	CZN6658	CZN6758	CZN5858	CZN6858	Chair (H x W x D)
Chair Weight	51.5 lbs	51.5 lbs	52 lbs	52 lbs	59 lbs	59 lbs	Chair (H x W x D)
Seat Width	19.5	22	19.5	22	23	23	Chair Weight
Seat Height	16.5 - 21.5	16.5 - 21.5	16.5 - 21.5	16.5 - 21.5	19.25 - 23.75	19.25 - 23.75	Seat Width
Seat Depth	16 - 18	16 - 18	16 - 18	16 - 18	19 - 21	19 - 21	Seat Height
Seat Angle	F5° - R10°	F8° - R18°	F5° - R10°	F8° - R18°	F5° - R10°	F5° - R10°	Seat Depth
Back Width	19	19	19	19	19	19	Seat Angle
Back Height	22 - 25	22 - 25	23 - 26	23 - 26	20 - 23	22 - 25	Back Width
Back Angle	105° - 120°	105° - 120°	105° - 120°	105° - 120°	105° - 120°	105° - 120°	Back Height
Lumbar Range	3	3	3	3	3	3	Back Angle
Base Diameter	26	26	26	26	26	26	Lumbar Range
COM Yardage	2 yd	2 yd	2 yd	2 yd	3 yd	3 yd	Base Diameter
Shipping Box (L x W x H)	36 x 26 x 19	36 x 26 x 19	36 x 26 x 19	36 x 26 x 19	28 x 26 x 24	28 x 26 x 24	COM Yardage
Shipping Weight	61.5 lbs	61.5 lbs	62 lbs	62 lbs	69 lbs	69 lbs	Shipping Box (L x W x H)
Shipping Method	KD	KD	KD	KD	KD	KD	Shipping Weight

All measurements are nominal and shown in inches.
Specs may differ for stools.

Grade 1
Grade 2
Grade 3
Grade 4
Grade 5
Grade 6
Grade 7
Grade 8
Grade 9

Cozi® 24/7

Formally N-dure & N-dure 400



Task/Conference

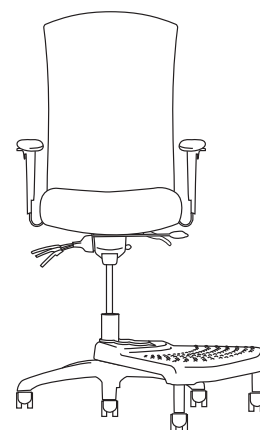

COZ6608-R8

Step 2 — Add option codes after model number COZ5638 - ___ - ___

General	Casters/Glides	Chair Cylinders	Stool Cylinders
CR Cleanroom to Class 100 \$120	C0 Carpet \$0	L1 3" Cylinder \$0	L4 8" Cylinder \$55
D2 Adjustable Lumbar Support \$100	C1 Hard Floor \$25	H4 Dual Pivot \$280 <i>Matching upholstery</i>	L5 10" Cylinder \$55
E ESD* \$290	Bases		Footrings for stool cylinders only
N N-dulgent® Memory Foam \$125	B0 26" Black \$0		R1 18" Black Plastic \$60
N2 TheraGel™ Memory Foam \$150	B7 26" Black Aluminum \$100		R2 20" Chrome \$80
Finishes	B14 28" Intensive Use Black \$125		NeXtep® for stool cylinders only
U1 Ballistic Upholstery \$0 <i>Back outer</i>			R8 8" w/Casters \$185
			R10 10" w/Casters \$185
			R18 8"/10" w/Casters \$295
			RW8 Wide 8" w/Casters \$295
			RW10 Wide 10" w/Casters \$295
			Also available w/glides.

Stool Options

Not available on (8) seat

For additional stool options
see page 104.

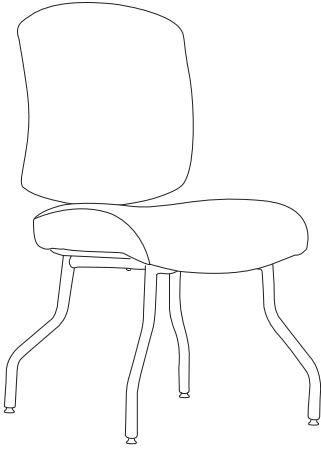

COG5654

Features

- Generous foam for optimal comfort
- Standard with upholstered back outer
- Passive weight dispensing design
- 2 base options

Standard Features

- No Arms
- Glides
- Black Frame

Step 1 — Model Number

Series Code	Back	Seat	Select an Arm	Select a Base																
COG Cozi Guest	5 Mid Back	6 Medium Seat	<table border="0"> <tr> <td>3</td> <td>3" Adjustable</td> <td>\$75</td> </tr> <tr> <td>5</td> <td>No Arms</td> <td>\$0</td> </tr> <tr> <td>6</td> <td>C Loop</td> <td>\$75</td> </tr> <tr> <td>7</td> <td>Chrome Loop</td> <td>\$75</td> </tr> </table>	3	3" Adjustable	\$75	5	No Arms	\$0	6	C Loop	\$75	7	Chrome Loop	\$75	<table border="0"> <tr> <td>4</td> <td>4-leg</td> </tr> <tr> <td>5</td> <td>Sled</td> </tr> </table>	4	4-leg	5	Sled
3	3" Adjustable	\$75																		
5	No Arms	\$0																		
6	C Loop	\$75																		
7	Chrome Loop	\$75																		
4	4-leg																			
5	Sled																			
COG	5	6	5	4																

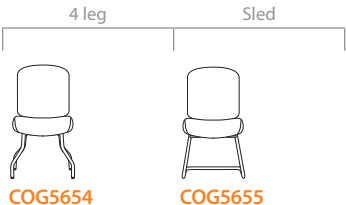

COG5654	COG5655	
\$913	\$979	Grade 1
\$973	\$1,039	Grade 2
\$1,033	\$1,099	Grade 3
\$1,103	\$1,169	Grade 4
\$1,173	\$1,239	Grade 5
\$1,253	\$1,319	Grade 6
\$1,333	\$1,399	Grade 7
\$1,423	\$1,489	Grade 8
\$1,513	\$1,579	Grade 9

37 x 20.5 x 24	36.5 x 20.5 x 24	Chair (H x W x D)
26.5 lbs	29.5 lbs	Chair Weight
19.5"	19.5"	Seat Width
18"	17.25"	Seat Height
18.5"	18.5"	Seat Depth
R3°	R4°	Seat Angle
19"	19"	Back Width
20"	20"	Back Height
109°	109°	Back Angle
20.5	20.5 x 23	Base Diameter
2 yd	2 yd	COM Yardage
30 x 27 x 39	30 x 27 x 39	Shipping Box (L x W x H)
36.5 lbs	39.5 lbs	Shipping Weight
FA	FA	Shipping Method

All measurements are nominal and shown in inches.

Step 2 — Add option codes after model number COG5654 - ___

General		
CB	Chrome Base	\$95

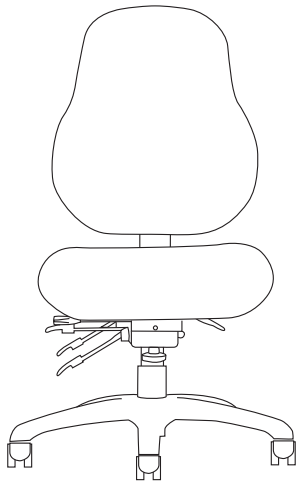

ES3206
High Back

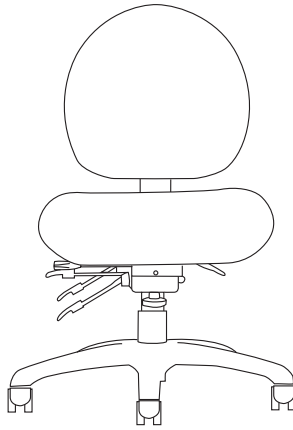

ES2206
Mid Back

Features

- Up to 13 active adjustments
- Contoured seat design
- Passive weight dispersion design
- Generous foam for optimal comfort
- Only available in Top Shelf, Cloud 9™ or Revive™

Standard Features

- No Arms
- Carpet Casters
- 26" Black Base
- 5" Cylinder
- Seat Slider

Need it Now? 5-day Quick Ship

Only standard features are available as Quick Ship unless otherwise noted.

QUICK SHIP FABRICS

For available quick ship fabrics see page 10.

Step 1 — Model Number

Series Code	Select a Back	Seat	Select an Arm		Mech
ES E-Series	2 Mid Back 3 High Back	2 Medium Seat	0 4" Adjustable 2 Lateral Sliding 5 No Arms 9 5-way Adjustable	\$125 \$140 \$0 \$150	6 Multi-tilt 
ES	3	2	0		6

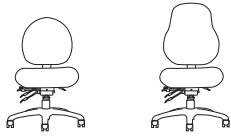

ES2256 **ES3256**

\$847	\$847
\$887	\$887

Top Shelf
Cloud 9 or Revive

35.75 x 26 x 26	40 x 26 x 26	Chair (H x W x D)
52.5 lbs	58 lbs	Chair Weight
20.5	20.5	Seat Width
17.5 – 22.5	17.5 – 22.5	Seat Height
16 – 18	16 – 18	Seat Depth
F1° – R20°	F1° – R16°	Seat Angle
17.5	19.5	Back Width
17 – 21	21 – 25	Back Height
102° – 120°	97° – 112°	Back Angle
4	4	Lumbar Range
26	26	Arm Width
2 yd	2 yd	COM Yardage
28 x 26 x 24	28 x 26 x 24	Shipping Box (L x W x H)
62.5 lbs	68 lbs	Shipping Weight
KD	KD	Shipping Method

All measurements are nominal and shown in inches.
Specs may differ for stools.

Step 2 — Add option codes after model number ES3206 - __ - __

General		Bases		Connexion® Arm		
F	Fring® Footrest <i>Only available on (B0) base</i>	\$50	B0 26" Black	\$0	Z1 Connexion Arm	\$350
Casters/Glides		Chair Cylinders		Connexion® Arm Attachments		
C0	Carpet	\$0	L1 3" Cylinder	\$0	A1 Tablet Holder	\$149
C1	Hard Floor	\$25	L3 5" Cylinder	\$0		

Stool Options

Stool Cylinders	
L4	8" Cylinder \$55
L5	10" Cylinder \$55
Footrings for stool cylinders only	
R1	18" Black Plastic \$60
R2	20" Chrome \$80
NeXtep® for stool cylinders only	
R8	8" w/Casters \$185
R10	10" w/Casters \$185
R18	8"/10" w/Casters \$295
RW8	Wide 8" w/Casters \$295
RW10	Wide 10" w/Casters \$295

Also available w/glides.

For additional stool options see page 104.



EMB2124
Pulled Fabric

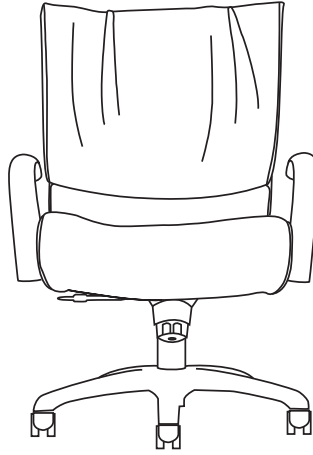

EMB2124-PT
Pillow Top

Features

- Up to 4 active adjustments
- Pillow top or pulled fabric upholstery
- Passive weight dispersion design
- Generous foam for optimal comfort
- Built-in lumbar

Standard Features

- C Loop Arms
- Carpet Casters
- 26" Black Base



TILT-SWIVEL









- 5" Cylinder

KNEE-TILT

- 3" Cylinder

Step 1 — Model Number

Series Code	Select a Back	Seat	Arm	Price	Select a Base
EMB Embrace	1 Mid Back 2 High Back	1 Medium Seat	2 C Loop	\$0	4 Tilt-swivel  0 Knee-tilt 
EMB	2	1	2		4

Tilt-swivel (Pulled)		Tilt-swivel (Pillow Top)		Knee-tilt (Pulled)		Knee-tilt (Pillow Top)		
								
EMB1124	EMB2124	EMB1124-PT	EMB2124-PT	EMB1120	EMB2120	EMB1120-PT	EMB2120-PT	
\$734	\$796	\$934	\$996	\$796	\$857	\$996	\$1,057	Grade 1
\$794	\$856	\$1,024	\$1,086	\$856	\$917	\$1,086	\$1,147	Grade 2
\$854	\$916	\$1,114	\$1,176	\$916	\$977	\$1,176	\$1,237	Grade 3
\$924	\$986	\$1,204	\$1,266	\$986	\$1,047	\$1,266	\$1,327	Grade 4
\$994	\$1,056	\$1,314	\$1,376	\$1,056	\$1,117	\$1,376	\$1,437	Grade 5
\$1,074	\$1,136	\$1,464	\$1,526	\$1,136	\$1,197	\$1,526	\$1,587	Grade 6
\$1,154	\$1,216	\$1,634	\$1,696	\$1,216	\$1,277	\$1,696	\$1,757	Grade 7
\$1,244	\$1,306	\$1,824	\$1,886	\$1,306	\$1,367	\$1,886	\$1,947	Grade 8
\$1,334	\$1,396	\$2,014	\$2,076	\$1,396	\$1,457	\$2,076	\$2,137	Grade 9
36 x 26 x 26	40 x 26 x 26	36 x 26 x 26	40 x 26 x 26	38.5 x 26 x 28	42.5 x 26 x 28	38.5 x 26 x 28	42.5 x 26 x 28	Chair (H x W x D)
57 lbs	57 lbs	57 lbs	57 lbs	57 lbs	57 lbs	57 lbs	57 lbs	Chair Weight
21	21	21	21	21	21	21	21	Seat Width
15.5 – 20.5	15.5 – 20.5	15.5 – 20.5	15.5 – 20.5	18 – 21	18 – 21	18 – 21	18 – 21	Seat Height
19.5	19.5	19.5	19.5	19.5	19.5	19.5	19.5	Seat Depth
R6° – F23°	R6° – F23°	R6° – F23°	R6° – F23°	R7° – F24°	R7° – F24°	R7° – F24°	R7° – F24°	Seat Angle
22	22	22	22	22	22	22	22	Back Width
22	25	22	25	22	25	22	25	Back Height
N/A	N/A	N/A	N/A	N/A	N/A	N/A	N/A	Back Angle
8	8	8	8	8	8	8	8	Arm Height
21.75	21.75	21.75	21.75	21.75	21.75	21.75	21.75	Arm Width
26	26	26	26	26	26	26	26	Base Diameter
2 yd	2 yd	2 yd	2 yd	2 yd	2 yd	2 yd	2 yd	COM Yardage – <i>Pulled</i>
4.5 yd	4.5 yd	4.5 yd	4.5 yd	4.5 yd	4.5 yd	4.5 yd	4.5 yd	COM Yardage – <i>Pillow Top</i>
37 x 23 x 22	37 x 23 x 22	37 x 23 x 22	37 x 23 x 22	37 x 23 x 22	37 x 23 x 22	37 x 23 x 22	37 x 23 x 22	Shipping Box (L x W x H)
67 lbs	67 lbs	67 lbs	67 lbs	67 lbs	67 lbs	67 lbs	67 lbs	Shipping Weight
FA	FA	FA	FA	FA	FA	FA	FA	Shipping Method

All measurements are nominal and shown in inches.
Not available in Cloud 9™, Revive™ or Top Shelf.

Step 2 — Add option codes after model number EMB212T - _ - _

Finishes

- CP Chrome Package** **\$295**
Chrome loop arm & polished aluminum base

Embrace Guest™

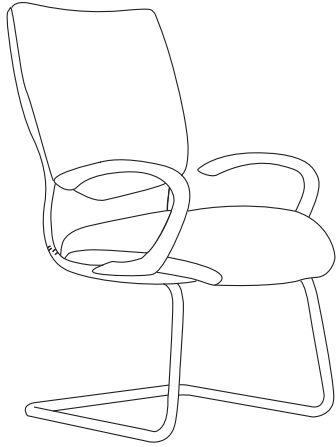

EMC022
Pulled Fabric

Task/Conference

Features





- Generous amount of foam in seat and back
- Fully upholstered back
- Optional C loop arms
- Sturdy, cantilever steel base

Standard Features

- No Arms
- Black Cantilever Base

Step 1 — Model Number

Series Code	Back	Seat	Select an Arm
EMC Embrace Guest	0 Mid Back	2 Medium Seat	0 No Arms 2 C Loop
EMC	0	2	2

Pulled	Pillow Top	Pulled	PillowTop
			
EMC020	EMC020-PT	EMC022	EMC022-PT
\$617	\$817	\$719	\$919
\$677	\$907	\$779	\$1,009
\$737	\$997	\$839	\$1,099
\$807	\$1,087	\$909	\$1,189
\$877	\$1,197	\$979	\$1,299
\$957	\$1,347	\$1,059	\$1,449
\$1,037	\$1,517	\$1,139	\$1,619
\$1,127	\$1,707	\$1,229	\$1,809
\$1,217	\$1,897	\$1,319	\$1,999

- Grade 1
- Grade 2
- Grade 3
- Grade 4
- Grade 5
- Grade 6
- Grade 7
- Grade 8
- Grade 9

38.5 x 25 x 28	38.5 x 25 x 28	38.5 x 25 x 28	38.5 x 25 x 28	Chair (H x W x D)
49 lbs	49 lbs	49 lbs	49 lbs	Chair Weight
21	21	21	21	Seat Width
20	20	20	20	Seat Height
20.5	20.5	20.5	20.5	Seat Depth
21	21	21	21	Back Width
22	22	22	22	Back Height
2 yd	2 yd	2 yd	2 yd	COM Yardage – <i>Pulled Fabric</i>
4.5 yd	4.5 yd	4.5 yd	4.5 yd	COM Yardage – <i>Pillow Top</i>
29 x 26.5 x 38	29 x 26.5 x 38	29 x 26.5 x 38	29 x 26.5 x 38	Shipping Box (L x W x H)
59 lbs	59 lbs	59 lbs	59 lbs	Shipping Weight
FA	FA	FA	FA	Shipping Method

All measurements are nominal and shown in inches.
 Not available in Cloud 9™, Revive™ or Top Shelf.

Step 2 — Add option codes after model number EMC022 - __ - __

General

CB Chrome Base \$95

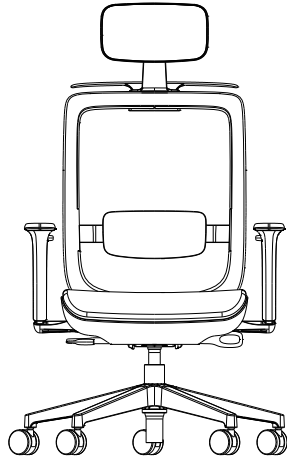

ICON4603-H2

Task/Conference

Features

- Medium gray mesh back
- Gray and black frame combination
- Replaceable/removable upholstered seat cushion – clips into place with no tools required
- Adjustable and removable lumbar support (easily slide up and down with no levers)
- Weight sensing mechanism without tension knob
- Class IV cylinder
- Finished seat bottom shell conceals mechanism
- 3 adjustment levers – height, synchro-tilt and seat slider

Standard Features

- No Arms
- Carpet Casters
- 26" Black Nylon Base
- 5" Cylinder
- Seat Slider
- Adjustable Lumbar

Need it Now? 5-day Quick Ship

Only standard features are available as Quick Ship unless otherwise noted.

QUICK SHIP ARMS

- 0 1D
- 5 No Arms
- 3 3D

QUICK SHIP FABRICS

For available quick ship fabrics see page 10.

Step 1 — Model Number

Series Code	Back	Seat	Select an Arm	Select a Mech
ICON Icon	4 Mesh Back	6 Medium Seat	0 1D \$40 5 No Arms \$0 3 3D \$70	3 Weight Sensitive 
ICON	4	6	0	3

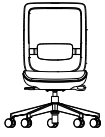

ICON4653

\$717	Grade 1
\$747	Grade 2
\$777	Grade 3
\$817	Grade 4
\$857	Grade 5
\$907	Grade 6
\$957	Grade 7
\$1,017	Grade 8
\$1,077	Grade 9

ICONSC — Replacement Seat Cover

\$100	Grade 1
\$130	Grade 2
\$160	Grade 3
\$200	Grade 4
\$240	Grade 5
\$290	Grade 6
\$340	Grade 7
\$400	Grade 8
\$460	Grade 9

36.5 x 26 x 26	Chair (H x W x D)
36.5 lbs	Chair Weight
18.5	Seat Width
16 – 21	Seat Height
18 – 20	Seat Depth
R3° – R6°	Seat Angle
18	Back Width
20.5	Back Height
104° – 128°	Back Angle
2.5	Lumbar Range
26	Base Diameter
1 yd	COM Yardage
	Shipping Box (L x W x H)
46.5 lbs	Shipping Weight
KD	Shipping Method

All measurements are nominal and shown in inches. Specs may differ for stools.

Step 2 — Add option codes after model number ICON4603 - __ - __

General

N	N-dulgent® Memory Foam	\$75
N2	TheraGel™ Memory Foam	\$150

Bases

B23	26" Black Nylon Base	\$0
B24	26" Polished Aluminum	\$90

Casters/Glides

C0	Carpet Casters	\$0
C1	Hard Floor Casters	\$25
C2	Glides	\$25

Chair Cylinders

L1	3" Cylinder	\$0
-----------	--------------------	------------

Headrests

H1	Headrest	\$60
	<i>Matching upholstery</i>	
H2	Headrest w/Coat Hanger	\$90
	<i>Matching upholstery</i>	

Stool Options

Stool Cylinders

L4	8" Cylinder	<i>(Stool Cylinder)</i>	\$55
L5	10" Cylinder	<i>(Stool Cylinder)</i>	\$55
L7	7" Cylinder	<i>(Stool Cylinder)</i>	\$55

Footrings for stool cylinders only

R1	18" Black Plastic	\$60
R2	20" Chrome	\$80

NeXtep® for stool cylinders only

R9	10" w/Glides	\$135
R10	10" w/Casters	\$185
R21	10"/12" w/Glides	\$235
R22	10"/12" w/Casters	\$295
RW9	Wide 10" w/Glides	\$235
RW10	Wide 10" w/Casters	\$295

For additional stool options see page 104.



NV3402

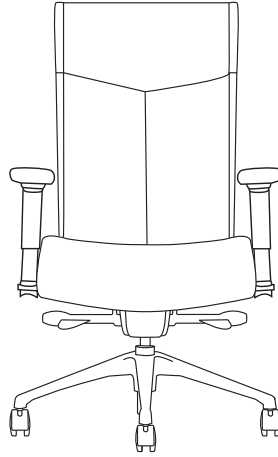

NV4122
Pillow Top

Features

- Up to 13 active adjustments
- High back with built-in lumbar
- Contoured seat with waterfall
- Passive weight dispersion design
- Removable inner pad in upper back
Only available on (4) back

Standard Features

- Lateral Sliding Arms
- 26" High Crown Black Base
- Carpet Casters
- 3" Cylinder
- Seat Slider

Step 1 — Model Number

Series Code	Select a Back	Select a Seat	Select an Arm	Mech
NV NV	3 High Back 4 High Back <i>Pillow Top</i>	1 Medium Seat <i>Pillow Top</i> 2 Large Seat <i>Pillow Top</i> 4 Medium Seat	0 Polished Aluminum Loop \$0 2 Lateral Sliding \$0 5 No Arms (\$100)	2 Synchro 
NV	4	1	2	2

Pillow Top Back



NV3422	NV3122	NV3222	NV4422	NV4122	NV4222	
\$1,377	\$1,428	\$1,479	\$1,479	\$1,530	\$1,581	Grade 1
\$1,447	\$1,498	\$1,549	\$1,549	\$1,600	\$1,651	Grade 2
\$1,517	\$1,568	\$1,619	\$1,619	\$1,670	\$1,721	Grade 3
\$1,597	\$1,648	\$1,699	\$1,699	\$1,750	\$1,801	Grade 4
\$1,677	\$1,728	\$1,779	\$1,779	\$1,830	\$1,881	Grade 5
\$1,767	\$1,818	\$1,869	\$1,869	\$1,920	\$1,971	Grade 6
\$1,857	\$1,908	\$1,959	\$1,959	\$2,010	\$2,061	Grade 7
\$1,957	\$2,008	\$2,059	\$2,059	\$2,110	\$2,161	Grade 8
\$2,057	\$2,108	\$2,159	\$2,159	\$2,210	\$2,261	Grade 9

41.5 x 26 x 26	41.5 x 26 x 26	41.5 x 26 x 26	42 x 26 x 26	42 x 26 x 26	42 x 26 x 26	Chair (H x W x D)
45.5 lbs	45.5 lbs	45.5 lbs	46.5 lbs	46.5 lbs	46.5 lbs	Chair Weight
19.5	20.5	20.5	19.5	20.5	20.5	Seat Width
18 – 21	19.5 – 22.5	19.5 – 22.5	18 – 21	19.5 – 22.5	19.5 – 22.5	Seat Height
18.5 – 21.5	15.5 – 18.5	19 – 22	18.5 – 21	18 – 20.5	18 – 20.5	Seat Depth
F5° – R10°	F5° – R10°	F5° – R10°	F6° – 12°	F8° – R14°	F8° – R14°	Seat Angle
19	19	19	19	19	19	Back Width
23.5 – 27.5	23.5 – 27.5	23.5 – 27.5	24 – 28	23.5 – 27.5	23.5 – 27.5	Back Height
100° – 115°	100° – 115°	100° – 115°	98° – 114°	100° – 115°	100° – 115°	Back Angle
4	4	4	4	4	4	Lumbar Range
26	26	26	26	26	26	Base Diameter
2.25 yd	2.25 yd	2.25 yd	2.5 yd	2.5 yd	2.5 yd	COM Yardage
28 x 28 x 42	28 x 28 x 42	28 x 28 x 42	28 x 28 x 42	28 x 28 x 42	28 x 28 x 42	Shipping Box (L x W x H)
65.5 lbs	65.5 lbs	65.5 lbs	66.5 lbs	66.5 lbs	66.5 lbs	Shipping Weight
FA	FA	FA	FA	FA	FA	Shipping Method

All measurements are nominal and shown in inches.
Not available in Cloud 9™, Revive™ or Top Shelf Upholstery.

Task/Conference

Step 2 — Add option codes after model number NV4122 - __ - __

General		Casters/Glides		Bases		Cylinders	
D2	Adjustable Lumbar Support \$100 <i>Not available on (3) back</i>	C0	Carpet \$0	B0	26" Black \$0	L3	5" Cylinder \$0
		C1	Hard Floor \$25	B6	26" Polished Aluminum \$140		
		C8	Chrome Carpet \$90	B15	26" High Crown Polished Aluminum \$55		
		C9	Chrome Hard Floor \$100	B16	26" High Crown Black \$0		
Finishes							
J	Upholstered Arm Pad \$65 <i>Only available on (2) arm</i>						

NV™ Guest

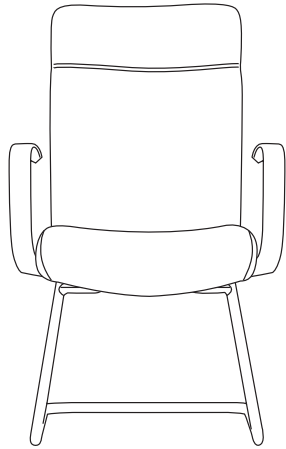

NVG2605

Task/Conference

Features

- Multiple arm options
- Option of two bases: sled or 4-leg
- Firm back support

Standard Features

- No Arms
- Black Cantilever Base

Step 1 — Model Number

Series Code	Back	Seat	Select an Arm	Select a Base										
NV NV Guest	2 Low Back	6 Medium Seat	<table border="0"> <tr> <td>0 Polished Aluminum Loop</td> <td>\$140</td> </tr> <tr> <td>2 Lateral Sliding</td> <td>\$140</td> </tr> <tr> <td>5 No Arms</td> <td>\$0</td> </tr> <tr> <td>7 Chrome Loop</td> <td>\$75</td> </tr> </table>	0 Polished Aluminum Loop	\$140	2 Lateral Sliding	\$140	5 No Arms	\$0	7 Chrome Loop	\$75	<table border="0"> <tr> <td>4 4-leg</td> </tr> <tr> <td>5 Sled</td> </tr> </table>	4 4-leg	5 Sled
0 Polished Aluminum Loop	\$140													
2 Lateral Sliding	\$140													
5 No Arms	\$0													
7 Chrome Loop	\$75													
4 4-leg														
5 Sled														
NVG	2	6	5	4										

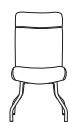

NVG2654	NVG2655
\$1,005	\$1,071
\$1,075	\$1,141
\$1,145	\$1,211
\$1,225	\$1,291
\$1,305	\$1,371
\$1,395	\$1,461
\$1,485	\$1,551
\$1,585	\$1,651
\$1,685	\$1,751

- Grade 1
- Grade 2
- Grade 3
- Grade 4
- Grade 5
- Grade 6
- Grade 7
- Grade 8
- Grade 9

40 x 20.5 x 24	39.5 x 20.5 x 24	Chair (H x W x D)
32 lbs	35 lbs	Chair Weight
19.5	19.5	Seat Width
18	17.25	Seat Height
19	19	Seat Depth
R3°	R4°	Seat Angle
19	19	Back Width
23	23	Back Height
102°	106°	Back Angle
N/A	N/A	Lumbar Range
20.5	20.5 x 23	Base Diameter
2.5 yd	2.5 yd	COM Yardage
28 x 28 x 42	28 x 28 x 42	Shipping Box (L x W x H)
42 lbs	45 lbs	Shipping Weight
FA	FA	Sipping Method

All measurements are nominal and shown in inches.
 Not available in Cloud 9™, Revive™ or Top Shelf.

Step 2 — Add option codes after model number NVG2654 - ___

General

CB	Chrome Base	\$95
-----------	--------------------	-------------

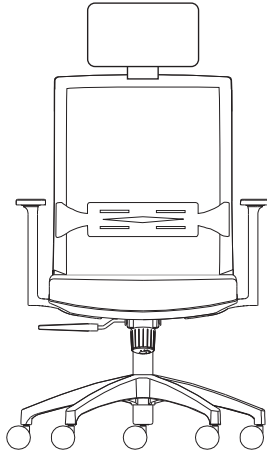

REN4604-D3-H

Features

- Black mesh back and frame
- Upholstery Graded-in programs with Carnegie, C.F. Stinson, Designtex, Guilford of Maine, KnollTextiles, Luna, Maharam, Mayer, Momentum, and Victor
- Tilt Swivel mechanism
- Class IV cylinder
- Heavy-duty casters and base

Standard Features

- No Arms
- Carpet Casters
- 26" Black Nylon Base
- 5" Cylinder

Need it Now? 5-day Quick Ship

Only standard features are available as Quick Ship unless otherwise noted.

QUICK SHIP ARMS

- 0 Adjustable Arms
- 5 No Arms

QUICK SHIP FABRICS

For available quick ship fabrics see page 10.

Step 1 — Model Number

Series Code	Back	Seat	Select an Arm	Select a Mech
REN Renati	4 Mesh Back	6 Medium Seat	0 Adjustable Arms \$40 5 No Arms \$0	4 Tilt-swivel 
REN	4	6	0	4



REN4654

\$507	Grade 1
\$537	Grade 2
\$567	Grade 3
\$607	Grade 4
\$647	Grade 5
\$697	Grade 6
\$747	Grade 7
\$807	Grade 8
\$867	Grade 9

37 x 26 x 26	Chair (H x W x D)
28.5 lbs	Chair Weight
19.5	Seat Width
16 – 21	Seat Height
18.5	Seat Depth
R1° – R16°	Seat Angle
17.5	Back Width
21	Back Height
100° – 125°	Back Angle
2.5	Lumbar Range
26	Base Diameter
1 yd	COM Yardage
	Shipping Box (L x W x H)
38.5 lbs	Shipping Weight
KD	Shipping Method

All measurements are nominal and shown in inches. Specs may differ for stools.

Step 2 — Add option codes after model number REN4604 - _ _ -

Stool Options

General		Casters/Glides		Headrest		Stool Cylinders	
D3	Adjustable Lumbar \$40	C0	Carpet \$0	H	Headrest \$60	L4	8" Cylinder \$55
N	N-dulgent® Memory Foam \$75	C1	Hard Floor \$25		<i>Matching upholstery</i>	L5	10" Cylinder \$55
N2	TheraGel™ Memory Foam \$150	C2	Glides \$25			L7	7" Cylinder \$55
Bases		Chair Cylinders				Footrings for stool cylinders only	
B23	26" Black Nylon Base \$0	L1	3" Cylinder \$0			R1	18" Black Plastic \$60
B24	26" Polished Aluminum \$90					R2	20" Chrome \$80
						NeXtep® for stool cylinders only	
						R9	10" w/Glides \$135
						R10	10" w/Casters \$185
						R21	10"/12" w/Glides \$235
						R22	10"/12" w/Casters \$295
						RW9	Wide 10" w/Glides \$235
						RW10	Wide 10" w/Casters \$295

For additional stool options see page 104.

Right Chair®

Now Including Balance Ergo

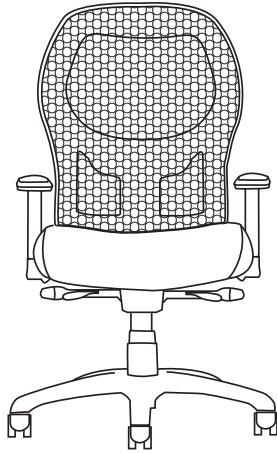

RCT4632

Task/Conference

Features

- Up to 13 active adjustments
- High back & contoured seat design
- Passive weight dispersion design
- Generous foam for optimal comfort
- 2 headrest options
- Convert mesh back to upholstered with optional sleeve
- Independent lumbar adjustment

Standard Features

- No Arms
- 26" Black Base
- Carpet Casters
- 5" Cylinder

Need it Now? 5-day Quick Ship

Only standard features are available as Quick Ship unless otherwise noted.



QUICK SHIP ARMS





- 3 3" Adjustable
- 5 No Arms
- 9 5-way Adjustable

QUICK SHIP FABRICS

For available quick ship fabrics see page 10.

Step 1 — Model Number

Series Code	Back	Select a Seat	Select an Arm	Select a Mech
RCT Right Chair	4 Mesh Back	6 Medium Seat 7 Large Seat	2 Lateral Sliding \$140 3 3" Adjustable \$75 5 No Arms \$0 8 360° NP \$175 <i>Only available on (2) synchro mech</i> 9 5-way Adjustable \$150	2 Synchro  6 Multi-tilt 
RCT	4	6	3	2

Synchro		Multi-tilt	
			
RCT4652	RCT4752	RCT4656	RCT4756
\$842	\$893	\$918	\$969
\$872	\$923	\$948	\$999
\$902	\$953	\$978	\$1,029
\$942	\$993	\$1,018	\$1,069
\$982	\$1,033	\$1,058	\$1,109
\$1,032	\$1,083	\$1,108	\$1,159
\$1,082	\$1,133	\$1,158	\$1,209
\$1,142	\$1,193	\$1,218	\$1,269
\$1,202	\$1,253	\$1,278	\$1,329
40.5 x 26 x 26	40.5 x 26 x 26	39.5 x 26 x 26	39.5 x 26 x 26
37 lbs	37 lbs	48 lbs	48.5 lbs
19.5	22	19.5	22
16.5 – 21.5	16.5 – 21.5	15.25 – 20.25	15.25 – 20.25
16.5 – 19.5	16.5 – 19.5	16 – 18	19 – 21
F5° – R14°	F5° – R14°	F6° – R11°	F8° – R18°
19	19	19	19
23	23	23	23
102° – 120°	102° – 120°	100° – 115°	100° – 115°
3	3	3	3
26	26	26	26
1 yd	1 yd	1 yd	1 yd
28 x 26 x 24	28 x 26 x 24	28 x 26 x 24	28 x 26 x 24
47 lbs	47 lbs	58 lbs	58.5 lbs
KD	KD	KD	KD

All measurements are nominal and shown in inches.

- Grade 1**
- Grade 2**
- Grade 3**
- Grade 4**
- Grade 5**
- Grade 6**
- Grade 7**
- Grade 8**
- Grade 9**

- Chair (H x W x D)
- Chair Weight
- Seat Width
- Seat Height
- Seat Depth (OPTIONAL)
- Seat Angle
- Back Width
- Back Height
- Back Angle
- Lumbar Range
- Base Diameter
- COM Yardage
- Shipping Box (L x W x H)
- Shipping Weight
- Shipping Method

Step 2 — Add option codes after model number RCT4632 - _ - _

General	Back Sleeve	Cylinders	Connexion® Arm
F Fring® Footrest \$50 <i>Only available on (B0) base</i>	S1 Grade 1 \$95	L1 3" Cylinder \$0	Z1 Connexion Arm \$350
N N-dulgent® Memory Foam \$75	S2 Grade 2 \$135	L3 5" Cylinder \$0	
N2 TheraGel™ Memory Foam \$150	S5 Ultraleather™ \$250		Connexion® Arm Attachments
S Seat Slider \$75	Casters/Glides	Headrests	A1 Tablet Holder \$149
	C0 Carpet \$0	HE Height Adjustable \$60 <i>Black vinyl</i>	
	C1 Hard Floor \$25	H4 Dual Pivot \$280 <i>Matching upholstery</i>	
	C2 Glides \$25	H5 Dual Pivot \$280 <i>Black faux leather</i>	
	Bases		
	B0 26" Black \$0		
	B6 26" Polished Aluminum \$140		
	B8 26" Brushed Aluminum \$140		

Right Chair® Stool

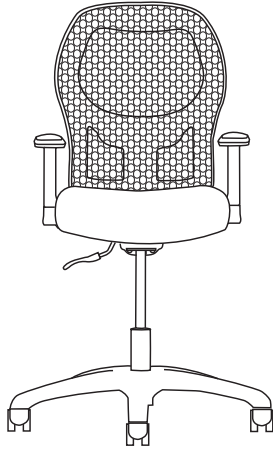

RCT4651

Task/Conference

Features

- High back & contoured seat design
- Passive weight dispersion design
- Generous foam for optimal comfort
- 2 headrest options
- Convert mesh back to upholstered with optional sleeve
- Independent lumbar adjustment

Standard Features

- No Arms
- 26" Black Base
- Carpet Casters
- 8" Cylinder

Need it Now? 5-day Quick Ship

Only standard features are available as Quick Ship unless otherwise noted.

QUICK SHIP ARMS

- 3 3" Adjustable
- 5 No Arms
- 9 5-way Adjustable

QUICK SHIP FABRICS







For available quick ship fabrics see page 10.

Step 1 — Model Number

Series Code	Back	Select a Seat	Select an Arm	Select a Mech
RCT Right Chair	4 Mesh Back	6 Medium Seat 7 Large Seat	2 Lateral Sliding \$140 3 3" Adjustable \$75 5 No Arms \$0 8 360° NP \$175 9 5-way Adjustable \$150	1 Basic 8 Standard 9 Deluxe-tilt
RCT	4	6	3	8

Right Chair® Stool

Task/Conference

Basic		Standard		Deluxe-tilt	
					
RCT4651	RCT4751	RCT4658	RCT4758	RCT4659	RCT4759
\$857	\$908	\$877	\$928	\$898	\$949
\$887	\$938	\$907	\$958	\$928	\$979
\$917	\$968	\$937	\$988	\$958	\$1,009
\$957	\$1,008	\$977	\$1,028	\$998	\$1,049
\$997	\$1,048	\$1,017	\$1,068	\$1,038	\$1,089
\$1,047	\$1,098	\$1,067	\$1,118	\$1,088	\$1,139
\$1,097	\$1,148	\$1,117	\$1,168	\$1,138	\$1,189
\$1,157	\$1,208	\$1,177	\$1,228	\$1,198	\$1,249
\$1,217	\$1,268	\$1,237	\$1,288	\$1,258	\$1,309

- Grade 1
- Grade 2
- Grade 3
- Grade 4
- Grade 5
- Grade 6
- Grade 7
- Grade 8
- Grade 9

44.5 x 26 x 26	44.5 x 26 x 26	45 x 26 x 26	45 x 26 x 26	45 x 26 x 26	45 x 26 x 26
34.5 lbs	34.5 lbs	45.5 lbs	45.5 lbs	46 lbs	46 lbs
19.5	22	19.5	22	19.5	22
21 – 29	21.25 – 29.25	22.5 – 30.5	22.5 – 30.5	22.5 – 30.5	22.5 – 30.5
17 – 18	17 – 18	15.5 – 17.5	15.5 – 17.5	15.5 – 17.5	15.5 – 17.5
R4°	R4°	R3°	R3°	R4°	R4°
19	19	19	19	19	19
23	23	23	23	23	23
102°	102°	95° – 99°	95° – 99°	95° – 99°	95° – 99°
3	3	3	3	3	3
26	26	26	26	26	26
1 yd	1 yd	1 yd	1 yd	1 yd	1 yd
28 x 26 x 24	28 x 26 x 24	28 x 26 x 24	28 x 26 x 24	28 x 26 x 24	28 x 26 x 24
44.5 lbs	44.5 lbs	55.5 lbs	55.5 lbs	56 lbs	56 lbs
KD	KD	KD	KD	KD	KD

Chair (H x W x D)

Chair Weight

Seat Width

Seat Height

Seat Depth (OPTIONAL)

Seat Angle

Back Width

Back Height

Back Angle

Lumbar Range

Base Diameter

COM Yardage

Shipping Box (L x W x H)

Shipping Weight

Shipping Method

All measurements are nominal and shown in inches.

Step 2 — Add option codes after model number RCT4638 - _ - _

General

N	N-dulgent® Memory Foam	\$75
N2	TheraGel™ Memory Foam	\$150

Back Sleeve

S1	Grade 1	\$95
S2	Grade 2	\$135
S5	Ultraleather™	\$250

Casters/Glides

C0	Carpet	\$0
C1	Hard Floor	\$25
C2	Glides	\$25

Bases

B0	26" Black	\$0
B6	26" Polished Aluminum	\$140

Chair Cylinders

L1	3" Cylinder	\$0
L3	5" Cylinder	\$0

Stool Cylinders

L4	8" Cylinder	\$0
L5	10" Cylinder	\$0
L7	7" Cylinder	\$0

Headrests

HE	Height Adjustable	\$60
	<i>Black vinyl</i>	
H4	Dual Pivot	\$280
	<i>Matching upholstery</i>	
H5	Dual Pivot	\$280
	<i>Black faux leather</i>	

Footrings for stool cylinders only

R1	18" Black Plastic	\$60
R2	20" Chrome	\$80

NeXtep® for stool cylinders only

R8	8" w/Casters	\$185
R10	10" w/Casters	\$185
R18	8"/10" w/Casters	\$295
RW8	Wide 8" w/Casters	\$295
RW10	Wide 10" w/Casters	\$295

Also available w/glides.

Connexion Arm

Z1	Connexion® Arm	\$350
-----------	-----------------------	--------------

Connexion Arm Attachments

A1	Tablet Holder	\$149
-----------	----------------------	--------------

For additional stool options see page 104.

Right Chair® Mesh

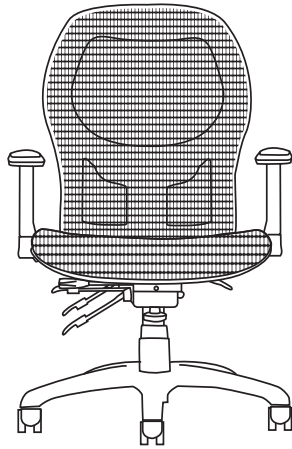

RCT5336

Task/Conference

Features

- Breathable mesh seat and back
- Adjustable lumbar
- 2 headrest options

Standard Features

- No Arms
- 26" Black Base
- Carpet Casters
- 5" Cylinder

Need it Now? 5-day Quick Ship

Only standard features are available as Quick Ship unless otherwise noted.



QUICK SHIP ARMS



- 3 3" Adjustable
- 5 No Arms
- 9 5-way Adjustable

QUICK SHIP FABRICS

For available quick ship fabrics see page 10.

Step 1 — Model Number

Series Code	Back	Seat	Select an Arm	Price	Select a Mech
RCT Right Chair	5 Mesh Back	3 Mesh Seat	2 Lateral Sliding	\$140	2 Synchro-tilt
			3 3" Adjustable	\$75	
			5 No Arms	\$0	6 Multi-tilt
			9 5-way Adjustable	\$150	
RCT	5	3	3		2

Synchro	Multi-tilt
	
RCT5352	RCT5356
\$918	\$995

Mesh

40.5 x 26 x 26	39.5 x 26 x 26	Chair (H x W x D)
41 lbs	41.5 lbs	Chair Weight
20	20	Seat Width
16.5 – 21.5	15.25 – 20.25	Seat Height
16.5 – 19.5	16.5 – 19	Seat Depth <small>(OPTIONAL)</small>
F1° – R5°	F6° – R11°	Seat Angle
19	19	Back Width
24	24	Back Height
100° – 120°	95° – 112°	Back Angle
3	3	Lumbar Range
26	26	Base Diameter
N/A	N/A	COM Yardage
28 x 26 x 24	28 x 26 x 24	Shipping Box (L x W x H)
51 lbs	51.5 lbs	Shipping Weight
KD	KD	Shipping Method

All measurements are nominal and shown in inches.

Step 2 — Add option codes after model number RCT5332 - __ - __

General		Casters/Glides		Bases		Headrests					
F	Fring® Footrest <i>Only available on (B0) base</i>	\$50	C0	Carpet	\$0	B0	26" Black	\$140	HE	Height Adjustable <i>Black vinyl</i>	\$60
S	Seat Slider	\$75	C1	Hard Floor	\$25	B6	26" Polished Aluminum	\$140	H5	Dual Pivot <i>Black faux leather</i>	\$280
			C2	Glides	\$25	Cylinders					
						L1	3" Cylinder	\$0			
						L3	5" Cylinder	\$0			

Right Chair® Mesh Stool

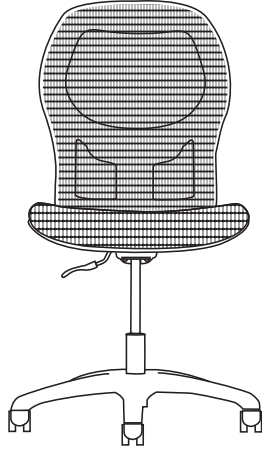

RCT5331

Task/Conference

Features

- Breathable mesh seat and back
- Adjustable lumbar
- 2 headrest options

Standard Features

- No Arms
- 26" Black Base
- Carpet Casters
- 8" Cylinder

Need it Now? 5-day Quick Ship

Only standard features are available as Quick Ship unless otherwise noted.



QUICK SHIP ARMS

- 3 3" Adjustable
- 5 No Arms
- 9 5-way Adjustable

QUICK SHIP FABRICS



For available quick ship fabrics see page 10.

Step 1 — Model Number

Series Code	Back	Seat	Select an Arm	Select a Mech
RCT Right Chair	5 Mesh Back	3 Mesh Seat	<ul style="list-style-type: none"> 2 Lateral Sliding \$140 3 3" Adjustable \$75 5 No Arms \$0 9 5-way Adjustable \$150 	<ul style="list-style-type: none"> 1 Basic  8 Standard  9 Deluxe-tilt 
RCT	5	3	3	8

Right Chair® Mesh Stool

Task/Conference

Basic	Standard	Deluxe-tilt
		
RCT5351	RCT5358	RCT5359
\$1,010	\$1,030	\$1,051
44.5 x 26 x 26	45 x 26 x 26	45 x 26 x 26
34.5 lbs	45.5 lbs	46 lbs
20	20	20
20.75 – 28.75	21.5 – 29.5	21.5 – 29.5
17.75 – 18.75	16 – 18	15.5 – 17.5
R4°	R3°	R4°
19	19	19
23	23	23
102°	95° – 99°	95° – 99°
3	3	3
26	26	26
N/A	N/A	N/A
28 x 26 x 24	28 x 26 x 24	28 x 26 x 24
44.5 lbs	55.5 lbs	56 lbs
KD	KD	KD

Mesh

- Chair (H x W x D)
- Chair Weight
- Seat Width
- Seat Height
- Seat Depth (OPTIONAL)
- Seat Angle
- Back Width
- Back Height
- Back Angle
- Lumbar Range
- Base Diameter
- COM Yardage
- Shipping Box (L x W x H)
- Shipping Weight
- Shipping Method

All measurements are nominal and shown in inches.

Step 2 — Add option codes after model number RCT5338 - __ - __

C0 Carpet	\$0	L1 3" Cylinder	\$0	HE Height Adjustable	\$60	R1 18" Black Plastic	\$60
C1 Hard Floor	\$25	L3 5" Cylinder	\$0	<i>Black vinyl</i>		R2 20" Chrome	\$80
C2 Glides	\$25			H5 Dual Pivot	\$280		
		Stool Cylinders		<i>Black faux leather</i>		NeXtep® for stool cylinders only	
Bases		L4 8" Cylinder	\$0			R8 8" w/Casters	\$185
B0 26" Black	\$0	L5 10" Cylinder	\$0			R10 10" w/Casters	\$185
B6 26" Polished Aluminum	\$140	L7 7" Cylinder	\$0			R18 8"/10" w/Casters	\$295
						RW8 Wide 8" w/Casters	\$295
						RW10 Wide 10" w/Casters	\$295

Also available w/glides.

For additional stool options see page 104.

Right Chair® Guest

Task/Conference

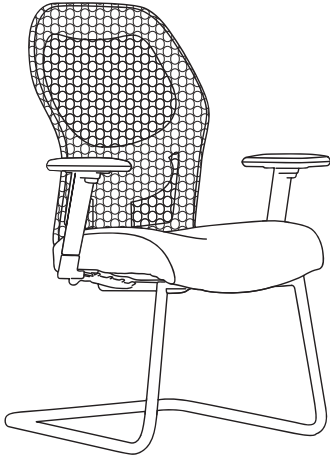

RCG4635

Features



- High back & contoured seat design
- Passive weight dispersion design
- Generous foam for optimal comfort

Standard Features

- No Arms
- Black Base

Step 1 — Model Number

Series Code	Back	Seat	Select an Arm	Select a Base
RCG Right Chair Guest	4 Mesh Back	6 Medium Seat	3 3" Adjustable \$75 5 No Arms \$0 6 C Loop \$75 7 Chrome Loop \$75	4 4-leg 5 Sled
RCG	4	6	3	5

4 Leg		Sled	
			
RCG4654	RCG4655		
\$719	\$785		Grade 1
\$749	\$815		Grade 2
\$779	\$845		Grade 3
\$819	\$885		Grade 4
\$859	\$925		Grade 5
\$909	\$975		Grade 6
\$959	\$1,025		Grade 7
\$1,019	\$1,085		Grade 8
\$1,079	\$1,145		Grade 9

40 x 20.5 x 24	39.5 x 20.5 x 24	Chair (H x W x D)
28 lbs	31 lbs	Chair Weight
19.5	19.5	Seat Width
18	17.25	Seat Height
17.5	17.5	Seat Depth
R3°	R4°	Seat Angle
19	19	Back Width
23	23	Back Height
100°	102°	Back Angle
3	3	Lumbar Range
20.5	20.5 x 23	Base Diameter
1 yd	1 yd	COM Yardage
30 x 27 x 39	30 x 27 x 39	Shipping Box (L x W x H)
38 lbs	41 lbs	Shipping Weight
FA	FA	Shipping Method

All measurements are nominal and shown in inches.

Step 2 — Add option codes after model number RCG4635 - __

General

CB Chrome Base \$95

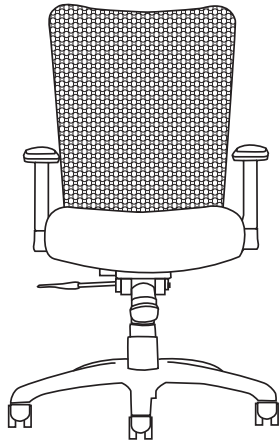

U4ia4600

Task/Conference

Features

- Up to 13 active adjustments
- Height adjustable mesh back
- Passive weight dispersion design
- Generous foam for optimal comfort
- Optional removable back sleeve for an upholstered look and feel

Standard Features

- No Arms
- Carpet Casters
- 26" Black Base
- Black Mesh Back

KNEE-TILT

- 3" Cylinder

SYNCHRO

- 5" Cylinder

Need it Now? 5-day Quick Ship

Only standard features are available as Quick Ship unless otherwise noted.

QUICK SHIP ARMS





- 3 3" Adjustable Arms
- 5 No Arms
- 9 5-way Adjustable Arms

QUICK SHIP FABRICS

For available quick ship fabrics see page 10.

Step 1 — Model Number

Series Code	Back	Select a Seat	Select an Arm	Select a Mech
U4ia U4ia	4 Mid Back	6 Medium Seat 7 Large Seat	0 4" Adjustable \$125 1 4" Adjustable w/Pivot \$150 2 Lateral Sliding \$140 3 3" Adjustable \$75 4 Swing \$295 5 No Arms \$0 6 C Loop \$75 7 Chrome Loop \$75 9 5-way Adjustable \$150	0 Knee-tilt 2 Synchro
U4ia	4	6	3	2

Knee-tilt		Synchro	
			
U4ia4650	U4ia4750	U4ia4652	U4ia4752
\$689	\$740	\$791	\$842
\$719	\$770	\$821	\$872
\$749	\$800	\$851	\$902
\$789	\$840	\$891	\$942
\$829	\$880	\$931	\$982
\$879	\$930	\$981	\$1,032
\$929	\$980	\$1,031	\$1,082
\$989	\$1,040	\$1,091	\$1,142
\$1,049	\$1,100	\$1,151	\$1,202

- Grade 1**
- Grade 2**
- Grade 3**
- Grade 4**
- Grade 5**
- Grade 6**
- Grade 7**
- Grade 8**
- Grade 9**

38.5 x 26 x 26	38.5 x 26 x 26	38 x 26 x 26	38 x 26 x 26	Chair (H x W x D)
34.5 lbs	36.5 lbs	36 lbs	36 lbs	Chair Weight
19.5	22	19.5	22	Seat Width
17.5 – 20.5	18 – 21	16.5 – 21.5	16.5 – 21.5	Seat Height
17.5	17.5	16.5 – 19	16.5 – 19	Seat Depth (OPTIONAL)
F5° – R10°	F6° – R11°	F5° – R15°	F5° – R15°	Seat Angle
19	19	19	19	Back Width
21 – 24	21 – 24	20.5 – 23.5	20.5 – 23.5	Back Height
100° – 115°	100° – 115°	100° – 128°	100° – 128°	Back Angle
3	3	3	3	Lumbar Range
26	26	26	26	Base Diameter
1 yd	1 yd	1 yd	1 yd	COM Yardage
36 x 26 x 19	36 x 26 x 19	36 x 26 x 19	36 x 26 x 19	Shipping Box (L x W x H)
44.5 lbs	46.5 lbs	46 lbs	46 lbs	Shipping Weight
KD	KD	KD	KD	Shipping Method

All measurements are nominal and shown in inches.

Step 2 — Add option codes after model number U4ia4632 - _ - _

General		Mesh Color		Casters/Glides		Connexion® Arm		
F	Fring® Footrest <i>Only available on (B0) base</i>	\$50	M0 Black Blurr	\$0	C0 Carpet	\$0	Z1 Connexion Arm <i>Not available with (6) & (7) arm</i>	\$350
N	N-dulgent® Memory Foam	\$75	M1 London (Navy)	\$25	C1 Hard Floor	\$25		
N2	TheraGel™ Memory Foam	\$150	M2 Cognac (Red)	\$25	C2 Glides	\$25		
S	Seat Slider <i>Only available on (2) mech</i>	\$75	M3 Mocha (Brown)	\$25			Connexion® Arm Attachments	
			M4 Ivory	\$25	Bases		A1 Tablet Holder	\$149
			M5 Silver	\$25	B0 26" Black	\$0		
					B6 26" Polished Aluminum	\$140		
			Back Sleeve		Cylinders			
			S1 Grade 1	\$100	L1 3" Cylinder	\$0		
			S2 Grade 2	\$250	L3 5" Cylinder	\$0		
			SS Ultraleather™	\$250				
			SU Stitched Ultraleather™	\$275				
			NR Non-removable	\$0				
			<i>Make a back sleeve non-removable</i>					

U4ia® Stool

Task/Conference

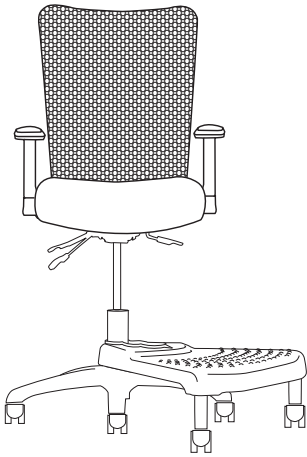

U4ia4608-R8

Features

- Height adjustable mesh back
- Passive weight dispersion design
- Generous foam for optimal comfort
- Optional removable back sleeve for an upholstered look and feel

Standard Features

- No Arms
- Carpet Casters
- 26" Black Base
- 8" Cylinder
- Black Mesh Back

Need it Now? 5-day Quick Ship

Only standard features are available as Quick Ship unless otherwise noted.

QUICK SHIP ARMS







- 3 3" Adjustable Arms
- 5 No Arms
- 9 5-way Adjustable Arms

QUICK SHIP FABRICS

For available quick ship fabrics see page 10.

Step 1 — Model Number

Series Code	Back	Select a Seat	Select an Arm	Select a Mech
U4ia U4ia	4 Mid Back	6 Medium Seat 7 Large Seat	0 4" Adjustable \$125 1 4" Adjustable w/Pivot \$150 2 Lateral Sliding \$140 3 3" Adjustable \$75 4 Swing \$295 5 No Arms \$0 6 C Loop \$75 7 Chrome Loop \$75 9 5-way Adjustable \$150	1 Basic 8 Standard 9 Deluxe-tilt
U4ia	4	6	3	8

Basic		Standard		Deluxe-tilt		
						
U4ia4651	U4ia4751	U4ia4658	U4ia4758	U4ia4659	U4ia4759	
\$806	\$857	\$826	\$877	\$847	\$898	Grade 1
\$836	\$887	\$856	\$907	\$877	\$928	Grade 2
\$866	\$917	\$886	\$937	\$907	\$958	Grade 3
\$906	\$957	\$926	\$977	\$947	\$998	Grade 4
\$946	\$997	\$966	\$1,017	\$987	\$1,038	Grade 5
\$996	\$1,047	\$1,016	\$1,067	\$1,037	\$1,088	Grade 6
\$1,046	\$1,097	\$1,066	\$1,117	\$1,087	\$1,138	Grade 7
\$1,106	\$1,157	\$1,126	\$1,177	\$1,147	\$1,198	Grade 8
\$1,166	\$1,217	\$1,186	\$1,237	\$1,207	\$1,258	Grade 9
42.5 x 26 x 26	42.5 x 26 x 26	44.5 x 26 x 26	44.5 x 26 x 26	44.5 x 26 x 26	44.5 x 26 x 26	Chair (H x W x D)
32 lbs	32 lbs	40 lbs	40 lbs	40 lbs	40 lbs	Chair Weight
19.5	22	19.5	22	19.5	22	Seat Width
21.5 – 29.5	21.5 – 29.5	22.5 – 30.5	22.5 – 30.5	22.5 – 30.5	22.5 – 30.5	Seat Height
17 – 18	17 – 18	16.5 – 19	16.5 – 19	16.5 – 19	16.5 – 19	Seat Depth (OPTIONAL)
R4°	R4°	R3°	R3°	R4°	R4°	Seat Angle
19	19	19	19	19	19	Back Width
22	22	22	22	22	22	Back Height
97°	97°	95° – 102°	95° – 102°	95° – 102°	95° – 102°	Back Angle
N/A	N/A	N/A	N/A	N/A	N/A	Lumbar Range
26	26	26	26	26	26	Base Diameter
1 yd	1 yd	1 yd	1 yd	1 yd	1 yd	COM Yardage
36 x 26 x 19	36 x 26 x 19	36 x 26 x 19	36 x 26 x 19	36 x 26 x 19	36 x 26 x 19	Shipping Box (L x W x H)
42 lbs	42 lbs	50 lbs	50 lbs	50 lbs	50 lbs	Shipping Weight
KD	KD	KD	KD	KD	KD	Shipping Method

All measurements are nominal and shown in inches.

Step 2 — Add option codes after model number U4ia4638 - _ - _

General		Back Sleeve not available on Quick Ship		Chair Cylinders		NeXtep® for stool cylinders only	
N	N-dulgent® Memory Foam \$75	S1	Grade 1 \$100	L1	3" Cylinder \$0	R8	8" w/Casters \$185
N2	TheraGel™ Memory Foam \$150	S2	Grade 2 \$250	L3	5" Cylinder \$0	R10	10" w/Casters \$185
Mesh Color		S5	Ultraleather™ \$250	Stool Cylinders		R18	8"/10" w/Casters \$295
M0	Black Blurr \$0	SU	Stitched Ultraleather™ \$275	L4	8" Cylinder \$0	RW8	Wide 8" w/Casters \$295
M1	London (Navy) \$25	NR	Non-removable \$0	L5	10" Cylinder \$0	RW10	Wide 10" w/Casters \$295
M2	Cognac (Red) \$25	<i>Make a back sleeve non-removable</i>		L7	7" Cylinder \$0	Also available w/glides.	
M3	Mocha (Brown) \$25	Casters/Glides		Footrings for stool cylinders only		Connexion® Arm	
M4	Ivory \$25	C0	Carpet \$0	R1	18" Black Plastic \$60	Z1 Connexion Arm \$350	
M5	Silver \$25	C1	Hard Floor \$25	R2	20" Chrome \$80	<i>Not available with (6) & (7) arm</i>	
		C2	Glides \$25			Connexion® Arm Attachments	
		Bases				A1 Tablet Holder \$149	
		B0	26" Black \$0				
		B6	26" Polished Aluminum \$140				

For additional stool options see page 104.

U4ia® Guest

Task/Conference

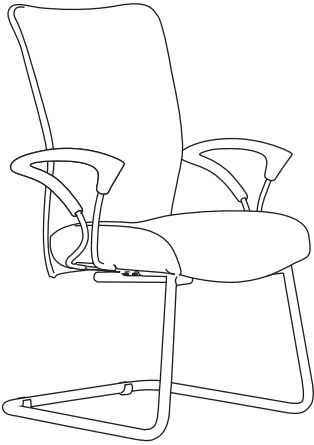

U4iaG4665

Features



- Mesh or upholstered back option
- Passive weight dispersion design
- Generous foam for optimal comfort
- Optional removable back sleeve for an upholstered look and feel

Standard Features

- No Arms
- Black Base

Step 1 — Model Number

Series Code	Back	Seat	Select an Arm	Select a Mech																
U4iaG U4ia Guest	4 Mid Back	6 Medium Seat	<table border="0"> <tr> <td>3</td> <td>3" Adjustable</td> <td>\$75</td> </tr> <tr> <td>5</td> <td>No Arms</td> <td>\$0</td> </tr> <tr> <td>6</td> <td>C Loop</td> <td>\$75</td> </tr> <tr> <td>7</td> <td>Chrome Loop</td> <td>\$75</td> </tr> </table>	3	3" Adjustable	\$75	5	No Arms	\$0	6	C Loop	\$75	7	Chrome Loop	\$75	<table border="0"> <tr> <td>4</td> <td>4-leg</td> </tr> <tr> <td>5</td> <td>Sled</td> </tr> </table>	4	4-leg	5	Sled
3	3" Adjustable	\$75																		
5	No Arms	\$0																		
6	C Loop	\$75																		
7	Chrome Loop	\$75																		
4	4-leg																			
5	Sled																			
U4iaG	4	6	3	5																

4-leg Base	Sled Base	
		
U4iaG4654	U4iaG4655	
\$729	\$796	Grade 1
\$759	\$826	Grade 2
\$789	\$856	Grade 3
\$829	\$896	Grade 4
\$869	\$936	Grade 5
\$919	\$986	Grade 6
\$969	\$1,036	Grade 7
\$1,029	\$1,096	Grade 8
\$1,089	\$1,156	Grade 9

38.75 x 20.5 x 24	38.25 x 20.5 x 24	Chair (H x W x D)
27.5 lbs	31 lbs	Chair Weight
19.5	19.5	Seat Width
18	17.25	Seat Height
18	18	Seat Depth
R3°	R4°	Seat Angle
19	19	Back Width
21"	21	Back Height
104°	104°	Back Angle
N/A	N/A	Lumbar Range
20.5	20.5 x 23	Base Diameter
1 yd	1 yd	COM Yardage
30 x 27 x 39	30 x 27 x 39	Shipping Box (L x W x H)
37.5 lbs	40.5 lbs	Shipping Weight
FA	FA	Shipping Method

All measurements are nominal and shown in inches.

Step 2 — Add option codes after model number U4iaG4635 - __ - __

General	Mesh Color	Back Sleeve not available on Quick Ship
CB Chrome Base \$95	M0 Black Blurr \$0	S1 Grade 1 \$100
	M1 London (Navy) \$25	S2 Grade 2 \$250
	M2 Cognac (Red) \$25	S5 Ultraleather™ \$250
	M3 Mocha (Brown) \$25	SU Stitched Ultraleather™ \$275
	M4 Ivory \$25	NR Non-removable \$0
	M5 Silver \$25	<i>Make a back sleeve non-removable</i>

ACTIVE/GUEST SEATING

Neutral Posture's active/guest seating are ideal for high traffic areas like waiting rooms, cafes or multi-purpose spaces. Whether you're looking for traditional guest chairs or seating for your

collaborative areas, they provide support, comfort and style sure to bring sophistication to any area. Having an impromptu meeting? Why not stay active with the ONGO.

ACTIVE/GUEST SEATING

Guest/Activity

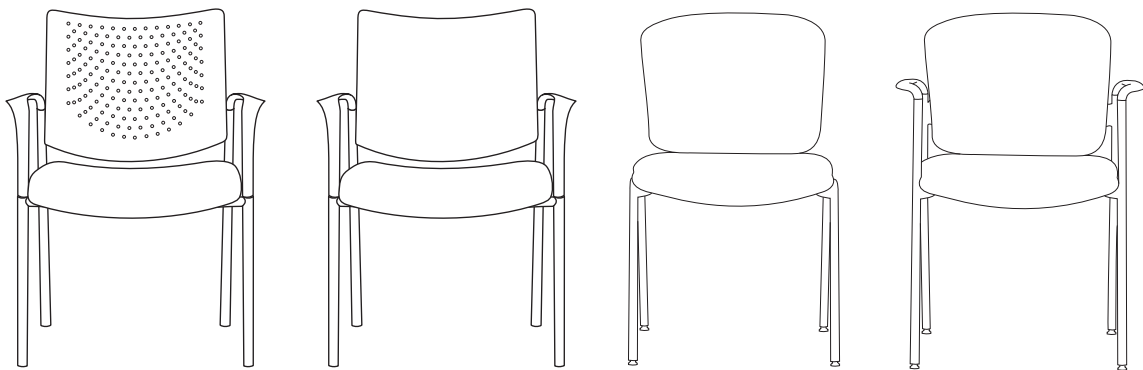

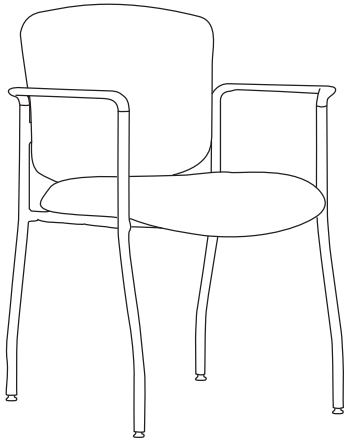

DCE211

Guest/Activity

Features

- Stackable, up to 5 high
- Generous amount of foam in seat and back
- Fully upholstered back
- Self-leveling non-marking glides
- Optional arms
- Optional ganging device

Standard Features

- Black Base
- Glides

Step 1 — Model Number

Series Code	Back	Seat	Select an Arm
DCE Dice	2 Back	1 Seat	1 Arms 5 No Arms
DCE	2	1	1

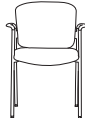
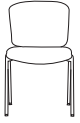

DCE215

DCE211

\$469	\$500	Grade 1
\$514	\$545	Grade 2
\$559	\$590	Grade 3
\$614	\$645	Grade 4
\$669	\$700	Grade 5
\$734	\$765	Grade 6
\$799	\$830	Grade 7
\$874	\$905	Grade 8
\$949	\$980	Grade 9

33 x 19 x 21.5	33 x 23.5 x 21.5	Chair (H x W x D)
19 lbs	20 lbs	Chair Weight
18	18	Seat Width
18.5	18.5	Seat Height
18	18	Seat Depth
19	19	Back Width
15.5	15.5	Back Height
N/A	21	Arm Width
2 yd	2 yd	COM Yardage
24 x 23 x 35	24 x 23 x 35	Shipping Box (L x W x H)
29 lbs	30 lbs	Shipping Weight
FA	FA	Shipping Method

All measurements are nominal and shown in inches.

Step 2 — Add option codes after model number DCE211 - __ - __

General

C6	Optional Casters <i>Set of 4</i>	\$30
CBL005	Ganging Device <i>2 per set</i>	\$30
CP	Chrome Package <i>Chrome frame</i>	\$40

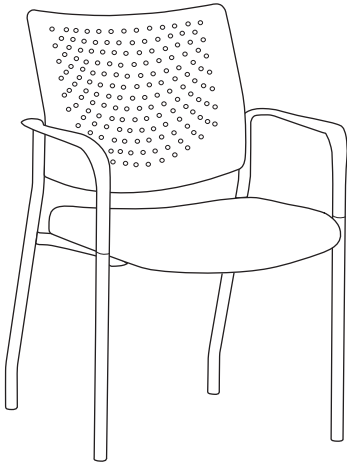

FAC160
Molded plastic back

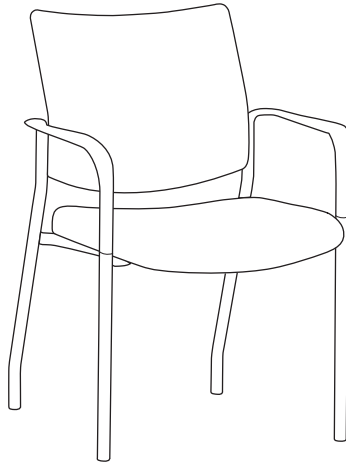

FAC160
Fully upholstered back

Features

- Standard black frame color
- Additional 9 frame colors available
- Two back styles – upholstered and molded plastic
- Upholstered back style stacks 5-high
- Molded plastic back style stacks 6-high
- Available with glides or casters
- Integrated wall saver leg design
- Optional ganging device

Standard Features

- Black Base
- Glides

Step 1 — Model Number

Series Code	Select a Back	Seat	Select an Arm
FAC Facet	1 Molded Plastic Back 2 Upholstered Back	6 Medium Seat	0 Arms 5 No Arms
FAC	1	6	0

Molded Plastic Back		Upholstered Back	
FAC165	FAC160	FAC265	FAC260
\$392	\$414	\$434	\$457
\$437	\$459	\$479	\$502
\$482	\$504	\$524	\$547
\$537	\$559	\$579	\$602
\$592	\$614	\$634	\$657
\$657	\$679	\$699	\$722
\$722	\$744	\$764	\$787
\$797	\$819	\$839	\$862
\$872	\$894	\$914	\$937

- Grade 1
- Grade 2
- Grade 3
- Grade 4
- Grade 5
- Grade 6
- Grade 7
- Grade 8
- Grade 9

33 x 22.5 x 23	33 x 24.5 x 23	33 x 22.5 x 23	33 x 24.5 x 23	Chair (H x W x D)
16.5 lbs	18 lbs	18.5 lbs	20 lbs	Chair Weight
18.5	18.5	18.5	18.5	Seat Width
18.5	18.5	18.5	18.5	Seat Height
18.5	18.5	18.5	18.5	Seat Depth
18.5	18.5	18.5	18.5	Back Width
15	15	15	15	Back Height
N/A	24.5	N/A	24.5	Arm Width
0.75 yd	0.75 yd	1.25 yd	1.25 yd	COM Yardage
26.5 lbs	28 lbs	28.5 lbs	30 lbs	Shipping Box (L x W x H)
FA	FA	FA	FA	Shipping Weight
				Shipping Method

All measurements are nominal and shown in inches.

Guest/Activity

Step 2 — Add option codes after model number FAC160 - _ - _

General		Frame Color Options	
C6	Optional Casters <i>Set of 4</i>	\$30	200 White \$120
CBL005	Ganging Device <i>2 per set</i>	\$30	201 Cream \$120
			202 Designer Beige \$120
			203 Grey \$120
			204 Jet Black \$120
			301 Champagne \$140
			303 Brass \$140
			304 Copper \$140

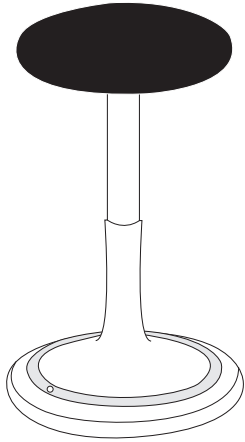

ONG0101W



Guest/Activity

Features

- Height adjustable with a high-quality gas spring
- Easy to handle & lightweight
- Auditory motion feedback

Standard Features

- Black Upholstery

Step 1 — Model Number

Series Code

ONGO ONGO

ONGO

Back



101

101

Select a Base

B Black
W White

W

Black	White
	
ONGO101B	ONGO101W
\$816	\$816

Black Knit

21.7 x 14.5 x 14.5	21.7 x 14.5 x 14.5	Chair (H x W x D)
13 lbs	13 lbs	Chair Weight
14.5	14.5	Seat Diameter
21.7 – 30.3	21.7 – 30.3	Seat Height
17 x 17 x 23	17 x 17 x 23	Shipping Box (L x W x H)
23 lbs	23 lbs	Shipping Weight
FA	FA	Shipping Method

All measurements are nominal and shown in inches.

Guest/Activity

Step 2 — Add option codes after model number ONGO101W - __

Seat Covers	
Light Green	\$50
Light Blue	\$50
Violet	\$50
Red	\$50

INDUSTRIAL/HEALTHCARE SEATING

Neutral Posture's industrial seating is designed for mobility and support during the busy work day. The industrial chairs were designed with a different mindset than most chairs because they serve such different and unique purposes. Industrial seating is designed to support some of the hardest workers out there. From the dental assistant on the Geo stool keeping track of the company's days to the car mechanic on the Stratus Urethane stool making sure the customer's car is in the best shape possible.

Industrial seating plays an imperative role in the backbone of almost every company. With an indefinite number of customization options in industrial seating you can build and design the perfect industrial chair that will support you and work just as hard as you do. From the urethane seats that are stain resistant and can be used in the roughest environments to the upholstered Adapta Stool for more long term use, industrial seating has everything you need to be supported and productive in your work.

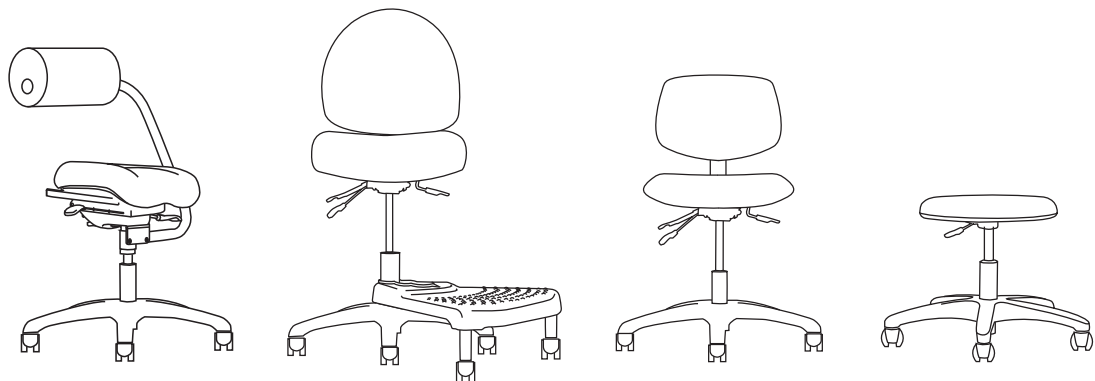

INDUSTRIAL/HEALTHCARE SEATING

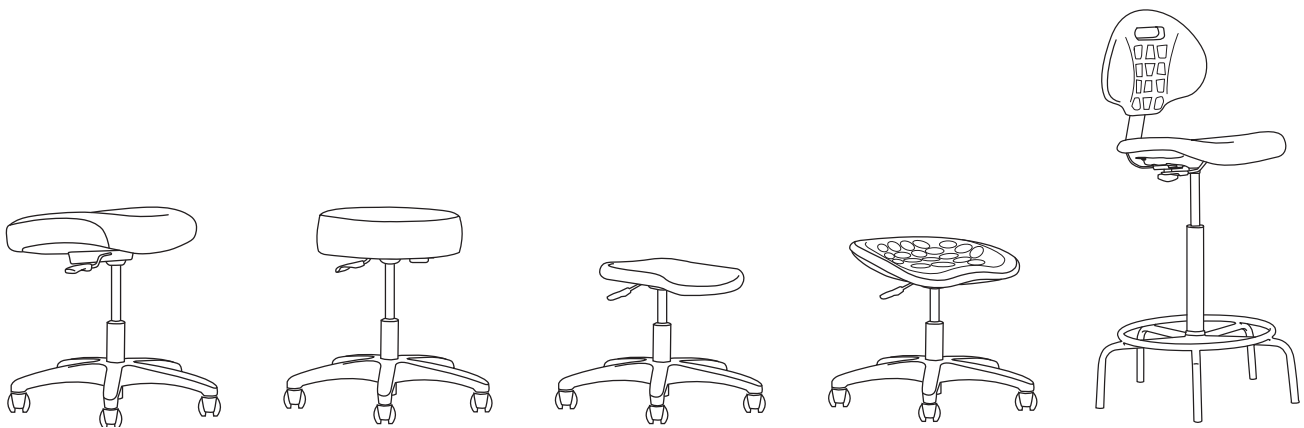

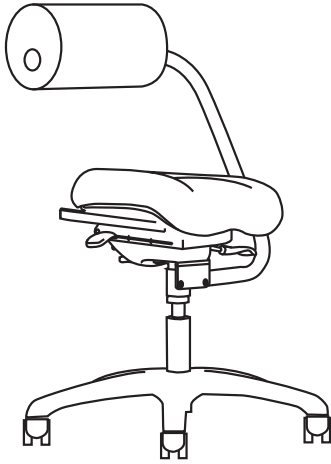

ABC1633

Industrial/Healthcare

Features







- ESD & Cleanroom options available
- Adjustable seat height, depth, angle & tension
- Adjustable AbRest™ height
- 4-way AbRest™ rotation
- AbRest™ swivel/pivot

Standard Features

- Black Arm
- Hard Floor Casters
- 26" Black Base
- 5" Cylinder

Step 1 — Model Number

Series Code	Select a Back	Select a Seat	Arm	Mech
ABC AbChair	1 Urethane AbRest 2 Upholstered AbRest	3 Medium Seat 5 Urethane Seat 6 Medium Seat <i>Moderate Contour</i>	3 Black Arm	3 Tilt <i>w/Seat Slider</i>
ABC	2	3	3	3

Urethane AbRest			Upholstered AbRest		
					
ABC1333	ABC1533	ABC1633	ABC2333	ABC2533	ABC2633
\$1,112	\$1,142	\$1,224	\$1,112	\$1,142	\$1,224
\$1,142	N/A	\$1,254	\$1,172	\$1,202	\$1,284
\$1,172	N/A	\$1,284	\$1,232	\$1,262	\$1,344
\$1,212	N/A	\$1,324	\$1,302	\$1,332	\$1,414
\$1,252	N/A	\$1,364	\$1,372	\$1,402	\$1,484
\$1,302	N/A	\$1,414	\$1,452	\$1,482	\$1,564
\$1,352	N/A	\$1,464	\$1,532	\$1,562	\$1,644
\$1,412	N/A	\$1,524	\$1,622	\$1,652	\$1,734
\$1,472	N/A	\$1,584	\$1,712	\$1,742	\$1,824
37 x 28 x 28	37 x 28 x 28	37 x 28 x 28	37 x 28 x 28	37 x 28 x 28	37 x 28 x 28
45 lbs	49 lbs	47 lbs	45 lbs	49 lbs	47 lbs
22	19	23	22	19	23
21 – 26	20 – 25	22 – 27	21 – 26	20 – 25	22 – 27
17	16	18	17	16	18
R1° – F16°	R1° – F16°	R1° – F16°	R1° – F16°	R1° – F16°	R1° – F16°
26	26	26	26	26	26
1 yd	N/A	1 yd	2 yd	1 yd	2 yd
36 x 26 x 19	36 x 26 x 19	36 x 26 x 19	36 x 26 x 19	36 x 26 x 19	36 x 26 x 19
55 lbs	59 lbs	57 lbs	55 lbs	59 lbs	57 lbs
FA	FA	FA	FA	FA	FA

- Grade 1
- Grade 2
- Grade 3
- Grade 4
- Grade 5
- Grade 6
- Grade 7
- Grade 8
- Grade 9

- Chair (H x W x D)
- Chair Weight
- Seat Width
- Seat Height
- Seat Depth
- Seat Angle
- Base Diameter
- COM Yardage
- Shipping Box (L x W x H)
- Shipping Weight
- Shipping Method

All measurements are nominal and shown in inches. Specs may differ for stools.

Step 2 — Add option codes after model number ABC2333 - __ - __

General		Bases	
CR Cleanroom to Class 100	\$120	B0 26" Black	\$0
<i>Urethane AbRest only</i>		B9 28" Chrome	\$160
E ESD*	\$290	B22 22" Black	\$0
Casters/Glides		Chair Cylinder	
C1 Hard Floor	\$0	L3 5" Cylinder	\$0
C2 Glides	\$0		
C3 Occupied Braking	\$185		
C4 Unoccupied Braking	\$60		

Stool Options

Stool Cylinder	
L4 8" Cylinder	\$55
Footrings for stool cylinders only	
R1 18" Black Plastic	\$60
R2 20" Chrome	\$80
NeXtep® for stool cylinders only	
R8 8" w/Casters	\$185
R10 10" w/Casters	\$185
R18 8"/10" w/Casters	\$295
RW8 Wide 8" w/Casters	\$295
RW10 Wide 10" w/Casters	\$295
Also available w/glides.	

For additional stool options see page 104.

Adapta™ Stool

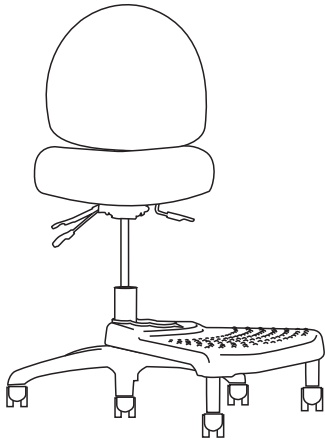

ADS4658-R8

Industrial/Healthcare

Features

- ESD & Cleanroom options available
- Optional NeXtep® platform with depth adjustments

Standard Features

- No Arms
- Hard Floor Casters
- 26" Black Base
- 8" Cylinder

Need it Now? 5-day Quick Ship

Only standard features are available as Quick Ship unless otherwise noted.

QUICK SHIP ARMS







- 3 3" Adjustable Arms
- 5 No Arms
- 9 5-way Adjustable Arms

QUICK SHIP FABRICS

For available quick ship fabrics see page 10.

Step 1 — Model Number

Series Code	Back	Select a Seat	Select an Arm	Select a Mech
ADS Adapta	5 Mid Back	6 Medium Seat 7 Large Seat	0 4" Adjustable \$125 1 4" Adjustable w/Pivot \$150 2 Lateral Sliding \$140 3 3" Adjustable \$75 4 Swing \$295 5 No Arms \$0 6 C Loop \$75 7 Chrome Loop \$75 9 5-way Adjustable \$150	1 Basic 8 Standard 9 Deluxe-tilt
ADS	5	6	3	8

Basic		Standard		Deluxe-tilt	
					
ADS5651	ADS5751	ADS5658	ADS5758	ADS5659	ADS5759
\$836	\$887	\$857	\$908	\$877	\$928
\$896	\$947	\$917	\$968	\$937	\$988
\$956	\$1,007	\$977	\$1,028	\$997	\$1,048
\$1,026	\$1,077	\$1,047	\$1,098	\$1,067	\$1,118
\$1,096	\$1,147	\$1,117	\$1,168	\$1,137	\$1,188
\$1,176	\$1,227	\$1,197	\$1,248	\$1,217	\$1,268
\$1,256	\$1,307	\$1,277	\$1,328	\$1,297	\$1,348
\$1,346	\$1,397	\$1,367	\$1,418	\$1,387	\$1,438
\$1,436	\$1,487	\$1,457	\$1,508	\$1,477	\$1,528
42 x 26 x 26	42 x 26 x 26	43 x 26 x 26	43 x 26 x 26	43 x 26 x 26	43 x 26 x 26
32 lbs	32 lbs	40.5 lbs	40.5 lbs	40.5 lbs	40.5 lbs
19.5	22	19.5	22	19.5	22
21.5 – 29.5	21.5 – 29.5	22.5 – 30.5	22.5 – 30.5	22.5 – 30.5	22.5 – 30.5
14.5 – 16	14.5 – 16	15 – 17.5	15 – 17.5	15 – 17.5	15 – 17.5
R4°	R4°	R3°	R3°	R4°	R4°
19.5	19.5	19.5	19.5	19.5	19.5
20.5	20.5	21 – 23.5	21 – 23.5	21 – 23.5	21 – 23.5
100°	100°	97° – 105°	97° – 105°	97° – 105°	97° – 105°
2.75	2.75	2.75	2.75	2.75	2.75
26	26	26	26	26	26
2 yd	2 yd	2 yd	2 yd	2 yd	2 yd
36 x 26 x 19	36 x 26 x 19	36 x 26 x 19	36 x 26 x 19	36 x 26 x 19	36 x 26 x 19
42 lbs	42 lbs	50.5 lbs	50.5 lbs	50.5 lbs	50.5 lbs
KD	KD	KD	KD	KD	KD

- Grade 1
- Grade 2
- Grade 3
- Grade 4
- Grade 5
- Grade 6
- Grade 7
- Grade 8
- Grade 9
- Chair (H x W x D)
- Chair Weight
- Seat Width
- Seat Height
- Seat Depth
- Seat Angle
- Back Width
- Back Height
- Back Angle
- Lumbar Range
- Base Diameter
- COM Yardage
- Shipping Box (L x W x H)
- Shipping Weight
- Shipping Method

All measurements are nominal and shown in inches.

Step 2 — Add option codes after model number ADS5638 - __ - __

Stool Options

General

- CR** Cleanroom to Class 100 \$120
- E** ESD* \$290
- F** Fring® Footrest \$100
Only available on (B0) base

Casters/Glides

- C1** Hard Floor \$0
- C2** Glides \$0
- C3** Occupied Braking \$185
- C4** Unoccupied Braking \$60
- C5** Single Wheel Industrial \$60
Hard floor

Bases

- B0** 26" Black \$0
- B3** 26" Spider Ring w/Glides \$140
Special shipping required
- B6** 26" Polished Aluminum \$140
- B9** 28" Chrome \$160
- B12** 28" Black \$110
- B20** 25" Spider Ring w/Glides \$145
Special shipping required

Chair Cylinders

- L1** 3" Cylinder \$0
- L3** 5" Cylinder \$0

Stool Cylinders

- L4** 8" Cylinder \$0
- L5** 10" Cylinder \$0
- L7** 7" Cylinder \$0

Footrings for stool cylinders only

- R1** 18" Black Plastic \$60
- R2** 20" Chrome \$80

NeXtep® for stool cylinders only

- R8** 8" w/Casters \$185
- R10** 10" w/Casters \$185
- R18** 8"/10" w/Casters \$295
- RW8** Wide 8" w/Casters \$295
- RW10** Wide 10" w/Casters \$295

Also available w/glides.

For additional stool options see page 104.

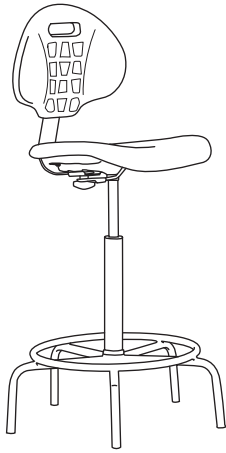

NCUGG1-L5-B20

Industrial/Healthcare

Features

- Cleanroom option available
- 3 active adjustments
- Concave low back
- Contoured, waterfall seat
- Textured urethane seat & back
- Wide variety of stool packages
- Urethane is resilient to harsh environments

Standard Features

- No Arms
- Hard Floor Casters
- 26" Black Base
- 5" Cylinder

Step 1 — Model Number

Series Code	Back	Seat	Mech
NCU Geo	G Geo Urethane Back	G Geo Urethane Seat	1 Basic 
NCU	G	G	1



NCUGG1

\$367

Urethane

38 x 26 x 26	Chair (H x W x D)
22 lbs	Chair Weight
18	Seat Width
15.5 – 20.5	Seat Height
16.5 – 19	Seat Depth
R 9°	Seat Angle
16.25	Back Width
14.5 – 18	Back Height
95° – 100°	Back Angle
N/A	Lumbar Range
26	Base Diameter
30.25 x 26 x 24	Shipping Box (L x W x H)
32 lbs	Shipping Weight
KD	Shipping Method

All measurements are nominal and shown in inches.
Specs may differ for stools.

Step 2 — Add option codes after model number NCUGG1 - __ - __

Stool Options

General		Bases		Chair Cylinders		Stool Cylinders		
CR	Cleanroom to Class 100	\$70	B0	26" Black	\$0	L1	3" Cylinder	\$0
F	Fring® Footrest	\$100	B3	26" Spider Ring w/Glides	\$140	L3	5" Cylinder	\$0
	<i>Only available on (B0) base</i>		B6	26" Polished Aluminum	\$140			
			B9	28" Chrome	\$160			
			B12	28" Black	\$110			
			B20	25" Spider Ring w/Glides	\$145			
				<i>Special shipping required</i>				
Casters/Glides							Footrings for stool cylinders only	
C1	Hard Floor	\$0				R1	18" Black Plastic	\$60
C2	Glides	\$0				R2	20" Chrome	\$80
C3	Occupied Braking	\$185						
C4	Unoccupied Braking	\$60					NeXtep® for stool cylinders only	
						R8	8" w/Casters	\$185
						R10	10" w/Casters	\$185
						R18	8"/10" w/Casters	\$295
						RW8	Wide 8" w/Casters	\$295
						RW10	Wide 10" w/Casters	\$295

Also available w/glides.

For additional stool options see page 104.

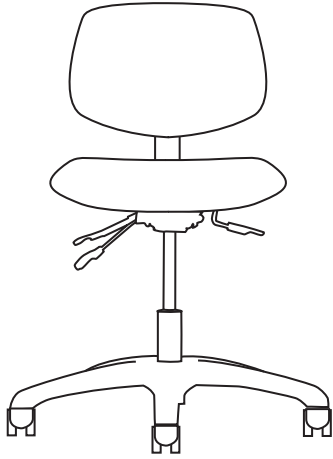

NCU552

Industrial/Healthcare



Features

- Cleanroom option available
- Passive weight dispersion design
- Urethane is resilient to harsh environments

Standard Features

- No Arms
- Hard Floor Casters
- 22" Black Base
- 5" Cylinder

Step 1 — Model Number

Series Code	Back	Seat	Select a Mech
NCU Graphite	5 Flat Urethane Back	5 Flat Urethane Seat	1 Basic  2 Standard  3 Deluxe-tilt 
NCU	5	5	2

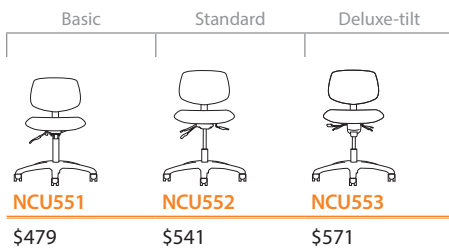

Urethane

33.5 x 26 x 26	31.5 x 26 x 26	31.5 x 26 x 26	Chair (H x W x D)
41 lbs	41 lbs	41 lbs	Chair Weight
19	19	19	Seat Width
14.25 – 19.25	14 – 19	14 – 19	Seat Height
17.5 – 20	18	18	Seat Depth
R 5°	R 5°	F 7° – R 4°	Seat Angle
17	17	17	Back Width
16.25	14.5 – 18.5	14.5 – 18.5	Back Height
103°	90° – 120°	105° – 136°	Back Angle
16 – 20	16 – 20	16 – 20	Lumbar Range
26	26	26	Base Diameter
28 x 26 x 24	28 x 26 x 24	28 x 26 x 24	Shipping Box (L x W x H)
51 lbs	51 lbs	51 lbs	Shipping Weight
KD	KD	KD	Shipping Method

All measurements are nominal and shown in inches. Specs may differ for stools.

Step 2 — Add option codes after model number NCU552 - __ - __

Stool Options

General	
CR Cleanroom to Class 100	\$70
F Fring® Footrest <i>Only available on (B0) base</i>	\$50
HD Heavy Duty	\$100
Arms	
A0 4" Adjustable	\$140
A2 T Arms	\$90
A3 3" Adjustable	\$90
A6 4" Adjustable Extended Height	\$190

Casters/Glides	
C1 Hard Floor	\$0
C2 Glides	\$0
C3 Occupied Braking	\$185
C4 Unoccupied Braking	\$60

Bases	
B0 26" Black	\$0
B3 26" Spider Ring w/Glides <i>Special shipping required</i>	\$140
B6 26" Polished Aluminum	\$140
B9 28" Chrome	\$160
B12 28" Black	\$110
B20 25" Spider Ring w/Glides <i>Special shipping required</i>	\$145

Chair Cylinders	
L1 3" Cylinder	\$0
L3 5" Cylinder	\$0

Stool Cylinders	
L4 8" Cylinder	\$55
L5 10" Cylinder	\$55
L7 7" Cylinder	\$55
Footrings for stool cylinders only	
R1 18" Black Plastic	\$60
R2 20" Chrome	\$80

NeXtep® for stool cylinders only	
R8 8" w/Casters	\$185
R10 10" w/Casters	\$185
R18 8"/10" w/Casters	\$295
RW8 Wide 8" w/Casters	\$295
RW10 Wide 10" w/Casters	\$295

Also available w/glides.

For additional stool options see page 104.

Stratus™ Upholstered

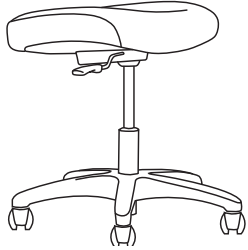

NBF064



NBF074

Industrial/Healthcare

Features

- ESD & Cleanroom options available
- Passive weight dispersion design
- Generous foam for optimal comfort

Standard Features

- Hard Floor Casters
- 22" Black Base
- 5" Cylinder

Need it Now? 5-day Quick Ship

Only standard features are available as Quick Ship unless otherwise noted.

QUICK SHIP FABRICS

For available quick ship fabrics see page 10.

Step 1 — Model Number

Series Code

NBF Stratus Upholstered

NBF

Back

0 Backless

0

Select a Seat

- 6** Medium Seat
- 7** Round Seat

6

Select a Mech

4 Basic







5 Ring



6 Tilt



6

Basic		Ring	Tilt
			
NBF064	NBF074	NBF075	NBF066
\$316	\$265	\$296	\$418
\$346	\$295	\$326	\$448
\$376	\$325	\$356	\$478
\$416	\$365	\$396	\$518
\$456	\$405	\$436	\$558
\$506	\$455	\$486	\$608
\$556	\$505	\$536	\$658
\$616	\$565	\$596	\$718
\$676	\$625	\$656	\$778

17 x 22 x 22	16 x 22 x 22	16 x 22 x 22	19 x 22 x 22
16.5 lbs	14 lbs	14 lbs	23.5 lbs
19.5	16	16	19.5
14.5 – 19.5	16 – 21	16 – 21	15.75 – 20.75
18.5	16	16	18.5
F 4.4°	N/A	N/A	F 4.7° – R 21.3°
22	22	22	22
1 yd	1 yd	1 yd	1 yd
28 x 26 x 24	25 x 25 x 11	25 x 25 x 11	28 x 26 x 24
26.5 lbs	24 lbs	24 lbs	33.5 lbs
KD	KD	KD	KD

- Grade 1
- Grade 2
- Grade 3
- Grade 4
- Grade 5
- Grade 6
- Grade 7
- Grade 8
- Grade 9

- Chair (H x W x D)
- Chair Weight
- Seat Width
- Seat Height
- Seat Depth
- Seat Angle
- Base Diameter
- COM Yardage
- Shipping Box (L x W x H)
- Shipping Weight
- Shipping Method

All measurements are nominal and shown in inches.
Specs may differ for stools.

Step 2 — Add option codes after model number NBF066 - __ - __

General	Bases
CR Cleanroom to Class 100 \$120	B0 26" Black \$0
E ESD* \$290	B3 26" Spider Ring w/Glides \$140 <i>Special shipping required</i>
F Fring® Footrest \$50 <i>Only available on (B0) base</i>	B6 26" Polished Aluminum \$140
Casters/Glides	B9 28" Chrome \$160
C1 Hard Floor \$0	B12 28" Black \$110
C2 Glides \$0	B20 25" Spider Ring w/Glides \$145 <i>Special shipping required</i>
C3 Occupied Braking \$185	B22 22" Black \$0
C4 Unoccupied Braking \$60	Chair Cylinders
C5 Single Wheel Industrial \$60 <i>Hard floor</i>	L1 3" Cylinder \$0
	L3 5" Cylinder \$0

Connexion® Arm	Connexion® Arm Attachments
Z1 Connexion Arm \$350 <i>Only available on (7) seat</i>	A1 Tablet Holder \$149 <i>Only available on (7) seat</i>

Stool Options

Stool Cylinders	Footrings for stool cylinders only
L4 8" Cylinder \$55	R1 18" Black Plastic \$60
L5 10" Cylinder \$55	R2 20" Chrome \$80
L7 7" Cylinder \$55	NeXtep® for stool cylinders only
	R8 8" w/Casters \$185
	R10 10" w/Casters \$185
	R18 8"/10" w/Casters \$295
	RW8 Wide 8" w/Casters \$295
	RW10 Wide 10" w/Casters \$295

Also available w/glides.

For additional stool options see page 104.

Stratus™ Urethane

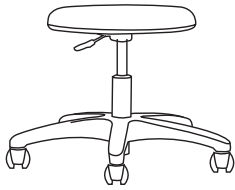

NBU044

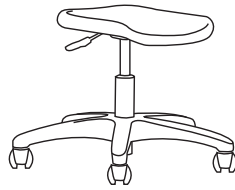

NBU054

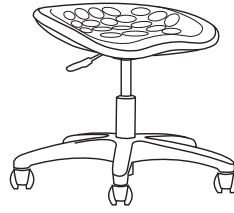

NBU084

Features



- Cleanroom option available
- Passive weight dispersion design
- Urethane is resilient to harsh environments

Standard Features

- Hard Floor Casters
- 22" Black Base
- 5" Cylinder

Industrial/Healthcare

Step 1 — Model Number







Series Code	Back	Select a Seat	Select a Mech
NBU Stratus Urethane	0 Backless	4 Round Seat 5 Flat Seat 8 Tractor Seat	4 Basic  5 Ring  6 Tilt 
NBU	0	4	6

Basic

Ring

Tilt

Stratus™ Urethane

Basic		Ring		Tilt	
					
NBU044	NBU054	NBU084	NBU045	NBU056	NBU086
\$204	\$326	\$357	\$235	\$428	\$459
13.5 x 22 x 22	14.5 x 22 x 22	13.5 x 22 x 22	13.5 x 22 x 22	15 x 22 x 22	13.25 x 22 x 22
17 lbs	28 lbs	22 lbs	17 lbs	28 lbs	22 lbs
14	19	19	14	19	19
13.5 – 18.5	14.5 – 19.5	13.5 – 18.5	13.5 – 18.5	15 – 20	13.25 – 18.25
14	18	13.5	14	18	13.5
R 0°	R 7°	R 2.5°	R 0°	F 2° – R 14°	F 2.5° – R 10°
22	22	22	22	22	22
N/A	N/A	N/A	N/A	N/A	N/A
25 x 25 x 11	25 x 25 x 11	25 x 25 x 11	25 x 25 x 11	25 x 25 x 11	25 x 25 x 11
27 lbs	38 lbs	32 lbs	27 lbs	38 lbs	32 lbs
KD	KD	KD	KD	KD	KD

Urethane

Chair (H x W x D)

Chair Weight

Seat Width

Seat Height

Seat Depth

Seat Angle

Base Diameter

COM Yardage

Shipping Box (L x W x H)

Shipping Weight

Shipping Method

All measurements are nominal and shown in inches.
Specs may differ for stools.

Step 2 — Add option codes after model number NBU046 - ___ - ___

Stool Options

General

CR	Cleanroom to Class 100	\$70
F	Fring® Footrest	\$50

Only available on (B0) base

Casters/Glides

C1	Hard Floor	\$0
C2	Glides	\$0
C3	Occupied Braking	\$185
C4	Unoccupied Braking	\$60
C5	Single Wheel Industrial	\$60

Hard floor

Bases

B0	26" Black	\$0
B3	26" Spider Ring w/Glides	\$140

Special shipping required

B6	26" Polished Aluminum	\$140
B9	28" Chrome	\$160
B12	28" Black	\$110
B20	25" Spider Ring w/Glides	\$145

Special shipping required

B22	22" Black	\$0
------------	------------------	------------

Chair Cylinders

L1	3" Cylinder	\$0
L3	5" Cylinder	\$0

Stool Cylinders

L4	8" Cylinder	\$55
L5	10" Cylinder	\$55
L7	7" Cylinder	\$55

Footrings for stool cylinders only

R1	18" Black Plastic	\$60
R2	20" Chrome	\$80

NeXtep® for stool cylinders only

R8	8" w/Casters	\$185
R10	10" w/Casters	\$185
R18	8"/10" w/Casters	\$295
RW8	Wide 8" w/Casters	\$295
RW10	Wide 10" w/Casters	\$295

Also available w/glides.

For additional stool options
see page 104.

NEXTEP®

- Adjustable depth (13", 15" & 17") from cylinder
Not available on Wide NeXtep®
- Wide platform for comfortable & ergonomic positioning of the feet & leg support
- Strong, stable step for entering & exiting the stool
- Supports up to 400 lbs

Only available on Neutral Posture stools

	w/Glides		w/Locking Casters	
8"	R7	\$135	R8	\$185
10"	R9	\$135	R10	\$185
12"	R11	\$135	R12	\$185
8"/10" Combo	R17	\$235	R18	\$295
10"/12" Combo	R21	\$235	R22	\$295
Wide 8" Platform	RW7	\$235	RW8	\$295
Wide 10" Platform	RW9	\$235	RW10	\$295

The NeXtep should only be used on stools that meet the current BIFMA tip test standards which were put in place in 2013.

R8

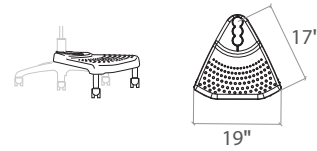

R18

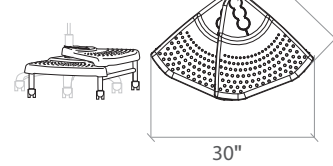

RW10

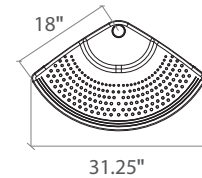

N-POSITION™

- Wide platform for comfortable & ergonomic positioning of the feet & leg support
- Top surface provides extra surface area (10" above ground) to support legs while sitting
- Supports up to 400 lbs

F8 (8" Platform) \$395

F10 (10" Platform) \$395

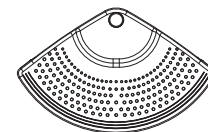
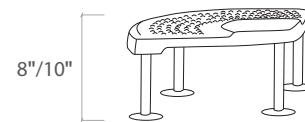

FOOTRINGS

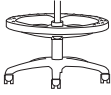

18" BLACK PLASTIC

- Flat surface
- Height adjustable

R1 \$60

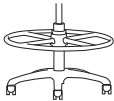

20" CHROME

- Height adjustable
- Twist/spin tightening

R2 \$80



FRING® W/BASE

- Aids shorter workers with a slightly higher "floor"
- Raised massage bumps provide a gentle rub to shoeless feet

FRF \$175

FOOTRESTS

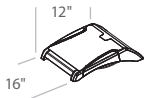

ADJUSTABLE

- Easy adjustment, folding support legs provide platform
- Tilt angles of 6°, 12°, 16° & 25°
- Provides support for the 5th percentile female
- Footrest surface covered by anti-fatigue rubber mat

FR16 \$175

STANDING DESK

- Dual-depth, dual-height footrails
- Multiple depth settings
- Chromed steel

FC12 \$310

FP12 \$385

FC12

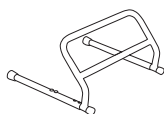

FP12

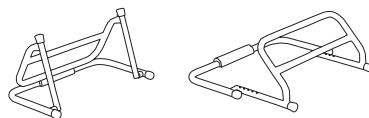

WORKPLACE ACCESSORIES

At Neutral Posture we are about more than just chairs. The office is all about being a place where you can be productive and get your task done with excellence and speed. In order to be the most productive you can be you need accessories to help. Nothing is worse than not having the right tool when you are trying to

complete a task. People of all industries work hard and our accessories collection is here to make life just a little bit easier. From our popular Connexion Arm®, that makes your tablet mobile and adjustable, to our monitor arms, our accessories are ground-breaking and will elevate your productivity to the next level with ease.

WORKPLACE ACCESSORIES

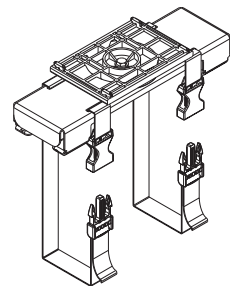
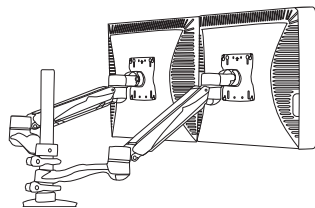
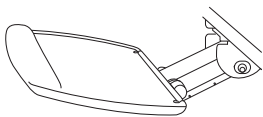

KEYBOARD ARMS



Leverless

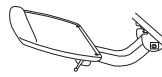

Sit/Stand



Econo

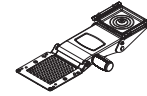

Dual Indicator
HFES compliant

Code	A	C	E	U
Leverless Height	✓	✓	N/A	N/A
Height	-6" – 2.5"	-6" – 8"	-5.25" – 0"	-6.5" – 2.38"
Tilt	-15° – 0°	-15° – 0°	-15° – 15°	-20° – 10°
Spring Assist	✓	✓	✓	✓
360° Rear Swivel	✓	✓	✓	✓
Track Length	23"	21"	18"	19"
Short Track (OPTIONAL)	18"	18"	N/A	N/A
Glide Track	✓	✓	✓	✓
Quick Ship	QS	QS	QS	
List	\$210	\$230	\$160	\$245

KEYBOARD TRAYS

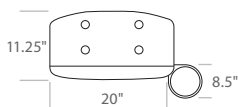

11

- Straights, corners & natural keyboards
- Anti-skid neoprene pads hold keyboard securely in place

List \$155

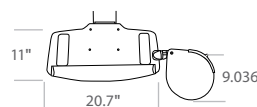

52

- Straight
- 20" "green" tray
- Height adjustable tilt & swivel mouse
- Gel filled palm rest

List \$325

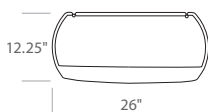

43 — SOFTOUCH™

- Straight
- Urethane over steel plate
- Includes mouse surface

List \$230

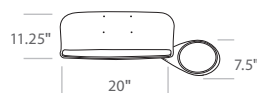











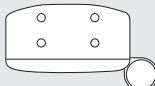
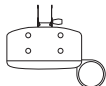
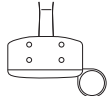

86 — ELEMENTAL®

- Straights, corners and natural keyboards
- Made from strong 100% recycled aluminum
- Polished surface

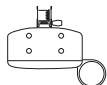
List \$295

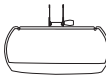
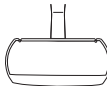

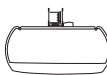
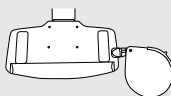
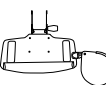
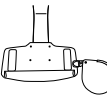
EASY COMBOS

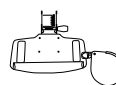
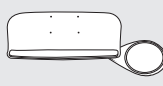
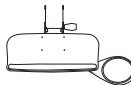
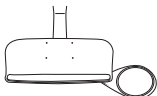
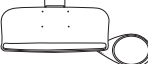
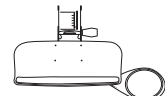
		Keyboard Tray			
					
		Leverless (A)	Sit/Stand (C)	Econo (E)	Dual Indicator (U)
Keyboard Arm	 11	 Easy A11 \$365	 Easy C11 \$385	 Easy E11 \$315	 Easy U11 \$400
	 43 - SofTouch™	 Easy A43 \$440	 Easy C43 \$460	 Easy E43 \$390	 Easy U43 \$475
	 52	 Easy A52 \$535	 Easy C52 \$555	 Easy E52 \$485	 Easy U52 \$570
	 86 - elementAI®	 Easy A86 \$505	 Easy C86 \$525	 Easy E86 \$455	 Easy U86 \$540

Easy Combo Options

- General
- S Short Track – 18" \$0**
Only available on (A) or (C) arms

MONITOR ARMS

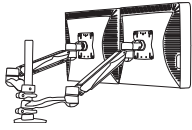

BOOST™ MONITOR ARM

- Yields 13" of vertical movement & 24" of extension
- Supports monitors weighing up to 20 lbs
- Effortlessly position two monitors at the same height on a single post
- Easily attach two arms on a single post without additional brackets
- Install three or more arms with an optional cross bar
- Convenient keyhole slots to effortlessly install monitor onto mounting plate
- Panel, slat wall & desk mounting options

NOTE: For multi-screen solutions, contact customerservice@neutralposture.com

Model #		List
Single Arm		
KCG-110B	Black	\$455
KCG-110S	Silver	\$455
Double Arm		
KCG-110DB	Black	\$899
KCG-110DS	Silver	\$899
Wall Mount		
KCG-WMB	Black	\$525
KCG-WMS	Silver	\$525

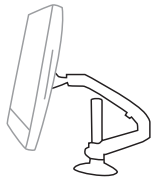

FREEDOM ARM

- Includes: vesa plate aluminum articulating arm & desk clamp base
- Tilt: Up 90°, Down 45°
- Pan: 180°
- Rotation: 360°
- Offers 14" of dynamic one-touch height adjustment
- Full extension range of 23.4"

Model #		List
918001	Silver	\$495

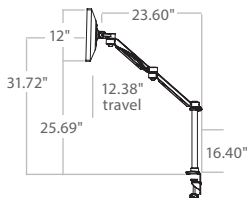

SIT/STAND MONITOR ARM

- Sturdy aluminum construction with vesa compatibility
- Width & depth adjustable fasteners
- Convenient pull handle

Model #		List
KCG-SSB	Black	\$575
KCG-SSS	Silver	\$575

CPU HOLDERS

CPU HOLDER

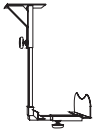

- Mounts easily under work surface storing CPU safely under desk & off the floor
- Adjusts to either a vertical or horizontal position
- Adjustable width of 5.5" – 9.8" & height of 15.5" – 20"

Model #
VCPUF **List**
\$175

CPU HOLDER W/STRAP

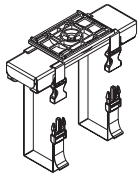

- CPU retracts on a 17" track & swivels to allow full accessibility & easy storage
- Accommodates CPU weighing up to 75 lbs & measuring 64" in perimeter
- Installation is quick & easy as straps adjust & fasten with buckles
- Soft touch anti-slip pads

Model #
VCPU **List**
\$195

TABLET HOLDER

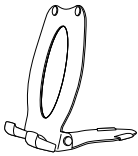

- Weight: 12 oz
- Dimensions: 6.76 x 5.5 x 2
- Holds tablets, phones or documents upright
- Easily adjusts for comfortable viewing angle
- Rests on desktop or flat surfaces

Model #
TABHLDR **List**
\$137

ADJUSTABLE HEIGHT TABLES

For adjustable height tables see Equity Price List

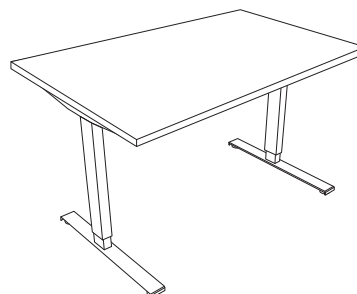

ACCESSORIES

STANDUP®



- Retrofits between most existing keyboard trays & keyboard arms
- Mounts directly to work surface without keyboard arm
- Additional 2" – 11" of height adjustment
- Infinite range positioning
- \$50 discount when ordered with any Easy Combo (page 109)

Model #
SUP04 **List**
\$420

FOREARM SUPPORTS

- Alleviates shoulder, neck & body burden
- Promotes good posture & ergonomic sitting
- Lightweight & portable

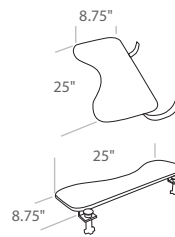

Model 1	Model 2	
160241 \$240	160243 \$240	w/Hooks
160242 \$240	160244 \$240	w/Screws

ANTI-FATIGUE FLOOR MATS

- Premium comfort will not bottom out or lose bounce over time
- Commercial grade heavy-duty polyurethane
- Matte texture provides optimum traction
- Beveled edge reduces tripping potential
- Only available in black

H	W	D	MODEL #	LIST
¾"	32"	20"	EAM3220B	\$285
¾"	48"	20"	EAM4820B	\$435
¾"	72"	20"	EAM7220B	\$648
¾"	36"	24"	EAM3624B	\$360
¾"	60"	36"	EAM6036B	\$828

FABRICS

Grade 1

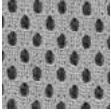

Spacer 1,000,000+ double rubs



Axis 90,000 double rubs
Momentum Textiles



Fuse 100,000 double rubs
Momentum Textiles

Grade 2



Ace 1,000,000+ double rubs
Not available on NV (3) back



Infinity 200,000 double rubs
Momentum Textiles

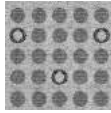

Knack 100,000 double rubs
Momentum Textiles

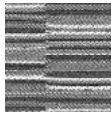

Lineup 100,000 double rubs
Momentum Textiles

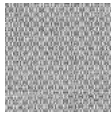

Marathon 200,000 double rubs
Momentum Textiles

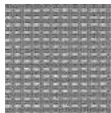

Millenium 200,000 double rubs
Momentum Textiles

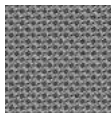

Odyssey 200,000 double rubs
Momentum Textiles

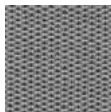

Top Shelf 250,000 double rubs
Not available on Embrace,
Embrace Guest & NV

Grade 3

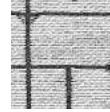

Intersect 80,000 double rubs
Momentum Textiles

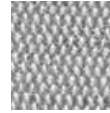

Messenger 100,000+
double rubs
CAL 133

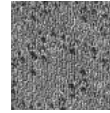

Cloud 9™ 335,000 double rubs
Not available on Embrace,
Embrace Guest & NV

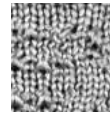

Revive™ 125,000 double rubs
Not available on Embrace,
Embrace Guest & NV



Avant 1,500,000 double rubs
CAL 133

LEATHERS

Grade 2



Canter 240,000 double rubs
Momentum Textiles

Grade 5



Natural 125,000 double rubs
Only available on Embrace
& Embrace Guest.
Available in black only.



Ultraleather™ 400,000
double rubs

Grade 9



Madras 335,000 double rubs

LEATHER DESCRIPTIONS

Canter

High-quality, durable faux leather

Natural

Semi-aniline contract leather, leather vinyl combo

Ultraleather™

Supple faux leather with an extremely
smooth, hand natural feel

Madras

Premium, semi-aniline hides with natural grain
and a smooth hand, leather/vinyl combo

QUICK SHIP FABRICS

Grade 1

Spacer	Pewter	200651
Spacer	Ink	200649
Spacer	Black	200648
Spacer	Wine	200650

Grade 2

Ace	Toast	200714
Ace	Peony	200710
Ace	Char	200703
Ace	Midnight	200709
Ace	Jet	200707
Top Shelf	Cherry	
Top Shelf	Navy	
Top Shelf	Graphite	
Top Shelf	Charcoal	

Grade 3

Cloud 9	Red Dawn
Cloud 9	Midnight Sky
Cloud 9	New Haze
Cloud 9	Fog
Cloud 9	Thunder

Graded In Fabrics

GRADED-IN AND COM UPHOLSTERY

Neutral Posture's furniture is manufactured to the highest standards. The unique nature of upholstery and the other materials that are used in production means that no two pieces of furniture will be exactly alike. Fabrics will upholster differently based on composition and construction. Neutral Posture makes every effort to ensure that each item is produced to our exacting standards, but cannot be held responsible for slight variations in upholstery, color and general appearance.

Our artisans are skilled in creating consistent finishes across all products and materials. However, the individual nature of the materials used in the construction of our furniture means that no two pieces of furniture are exactly alike. Similarly, the images in our publications are as accurate as your monitor is calibrated but customers are reminded that colors and finishes may vary according to the unique nature of each item of furniture.

Neutral Posture will not be responsible for variances in the sit and performance of a chair due to the fact that certain fabrics such as knits will perform differently than milled fabrics. Generally, knitted fabrics will create a softer sit and milled fabrics will provide a firmer sit.

For specific color matching requirements please contact the Sales Support Department. Please note: The Finish Codes used by Neutral Posture are used as a guide to the appearance of the furniture and should not be used to determine the specific materials used in the construction of an item of furniture.

The Neutral Posture Upholstery Department is pleased to offer a Graded-in program and also accepts C.O.M. for most products. For certain items or in cases of unusual or difficult fabric patterns additional material may be required. Any unusual or special cutting requirements must be requested in writing and a full-width fabric repeat sent to the Sales Support Department in order for a quotation to be provided. The customer is responsible for shipping C.O.M. to our Upholstery Department.

CARNEGIE		
Manufacturer	Pattern	Grade
Carnegie	360	8
Carnegie	Abacus Embroider S	8
Carnegie	Adrenaline	6
Carnegie	Alex	7
Carnegie	Allure	5
Carnegie	Anchor	7
Carnegie	Aria	Call
Carnegie	Artisan Embroider S	9
Carnegie	Axis Embroider S	8
Carnegie	Bangle	7
Carnegie	Bardot	6
Carnegie	Barre	7
Carnegie	Basket	6
Carnegie	Bauble	8
Carnegie	Bliss	7
Carnegie	Blowing Bubbles	7
Carnegie	Bounce	5
Carnegie	Brick Lane	6
Carnegie	Brimfield	6
Carnegie	Buff	5
Carnegie	Buzz	7
Carnegie	Camden	6
Carnegie	Cascade Applique S	Call
Carnegie	Channel	5
Carnegie	Chelsea	5
Carnegie	Chroma	9
Carnegie	Circuit S	5
Carnegie	Cirque Couture	Call
Carnegie	Crossing	6
Carnegie	Cycle S	5
Carnegie	Dash S	5
Carnegie	Dazzle	8
Carnegie	Delight	7
Carnegie	Departure	5
Carnegie	Edge	6
Carnegie	Fields	7
Carnegie	Flash Back S	5
Carnegie	Flux S	5
Carnegie	Flying Kites	7
Carnegie	Four Square	7
Carnegie	Fractal Emboss S	6
Carnegie	Fragment Emboss S	6
Carnegie	Fresco	6
Carnegie	Fusion	6
Carnegie	Gamma S	5
Carnegie	Genome Embroider S	8
Carnegie	Gossip	6
Carnegie	Grid	6
Carnegie	Groove	5
Carnegie	Hashtag	5
Carnegie	Havana S	6
Carnegie	Hepburn	6
Carnegie	Herald	5
Carnegie	Heritage	Call
Carnegie	Herringbone S	5
Carnegie	Hide	5
Carnegie	Hive	7
Carnegie	Hoop Embroider S	8

Manufacturer	Pattern	Grade
Carnegie	Icon	9
Carnegie	In Line	6
Carnegie	Index	4
Carnegie	Infinity Flora	Call
Carnegie	Infinity Plaid	8
Carnegie	Infinity Plush	7
Carnegie	Infinity Stripe	8
Carnegie	Journey	7
Carnegie	Kaleidoscope S	6
Carnegie	Kid	5
Carnegie	Koi	7
Carnegie	Lineage	8
Carnegie	Locket	9
Carnegie	Loft	8
Carnegie	Maxwell Street	8
Carnegie	Maze	7
Carnegie	Merkhet	6
Carnegie	Mesh S	5
Carnegie	Meteor S	5
Carnegie	Monocle Embroider	9
Carnegie	Monroe	6
Carnegie	Morocco	Call
Carnegie	Nuance	9
Carnegie	Obelisk	6
Carnegie	Ola	Call
Carnegie	Oxford	5
Carnegie	Paparazzi	6
Carnegie	Pebble	7
Carnegie	Pixie Applique S	Call
Carnegie	Pony	5
Carnegie	Pop Emboss S	6
Carnegie	Prism S	5
Carnegie	Quarry S	5
Carnegie	Rail Trail	7
Carnegie	Rattan S	5
Carnegie	Reveal	8
Carnegie	Sail	6
Carnegie	Sequence S	6
Carnegie	Shimmy	6
Carnegie	Siesta	9
Carnegie	Silhouette Embroider S	8
Carnegie	Slide S	6
Carnegie	Soiree	8
Carnegie	Sojourn	9
Carnegie	Spark	9
Carnegie	Spyro Embroider S	7
Carnegie	Strata S	5
Carnegie	Strie S	5
Carnegie	Sway Embroider S	7
Carnegie	Tempo	7
Carnegie	Topiary Embroider S	9
Carnegie	Touchstone	7
Carnegie	Trestle	7
Carnegie	Tweed S	5
Carnegie	Twinkle	7
Carnegie	Veneer Emboss S	6
Carnegie	Versailles Emboss S	6
Carnegie	Verse	4
Carnegie	Vintage	7

Manufacturer	Pattern	Grade	Manufacturer	Pattern	Grade	Manufacturer	Pattern	Grade
Carnegie	Whirlybird	7	C.F. Stinson	Deflection	6	C.F. Stinson	On the Money	5
Carnegie	Wilderness	9	C.F. Stinson	Detail	6	C.F. Stinson	Outlander	4
Carnegie	Wired	7	C.F. Stinson	Double Time w/ Agion	7	C.F. Stinson	Pacifica	7
Carnegie	Wish	7	C.F. Stinson	Duet	5	C.F. Stinson	Park Avenue	6
Carnegie	Wonder	6	C.F. Stinson	Elderberry	6	C.F. Stinson	Perimeter	5
			C.F. Stinson	Equinox	5	C.F. Stinson	Persuasion	5
			C.F. Stinson	Fast Lane	3	C.F. Stinson	Polka	3
			C.F. Stinson	Fenestra	7	C.F. Stinson	Portico	5
			C.F. Stinson	Figment	6	C.F. Stinson	Posh	5
			C.F. Stinson	Firefly	6	C.F. Stinson	Profile	5
			C.F. Stinson	Flex	5	C.F. Stinson	Raquette	6
			C.F. Stinson	Flight	7	C.F. Stinson	Realm	5
			C.F. Stinson	Flip Flops	6	C.F. Stinson	Respite	6
			C.F. Stinson	Florentine	5	C.F. Stinson	Retrograde	3
			C.F. Stinson	Folio	6	C.F. Stinson	Revolution	5
			C.F. Stinson	Freehand	5	C.F. Stinson	Riddle	4
			C.F. Stinson	Furrows	4	C.F. Stinson	Rolling Stones	6
			C.F. Stinson	Geodesic	6	C.F. Stinson	Salinas	7
			C.F. Stinson	Glacier	3	C.F. Stinson	San Simeon	7
			C.F. Stinson	Gradation	5	C.F. Stinson	Satellite	5
			C.F. Stinson	Gravity	5	C.F. Stinson	Seagrass	6
			C.F. Stinson	Hands On	6	C.F. Stinson	Second Act	6
			C.F. Stinson	Happy Hour	5	C.F. Stinson	Sequence	4
			C.F. Stinson	Happy Tappy	7	C.F. Stinson	Sideline	5
			C.F. Stinson	Haven	5	C.F. Stinson	Skyline	6
			C.F. Stinson	Helix	6	C.F. Stinson	Snuggle	5
			C.F. Stinson	Hi-Fi	3	C.F. Stinson	Splash	6
			C.F. Stinson	Hive	3	C.F. Stinson	Sprint	3
			C.F. Stinson	Horizons	6	C.F. Stinson	Squire	5
			C.F. Stinson	Hot Spot	5	C.F. Stinson	Stellar	5
			C.F. Stinson	Hourglass	6	C.F. Stinson	Stipple	5
			C.F. Stinson	Hudson	7	C.F. Stinson	Straight and Narrow	6
			C.F. Stinson	Hush	6	C.F. Stinson	Sumatran Palm	6
			C.F. Stinson	I Spy	6	C.F. Stinson	Summit	5
			C.F. Stinson	Inside Track	4	C.F. Stinson	Sunburst	6
			C.F. Stinson	Interplay	5	C.F. Stinson	Supersillyness	7
			C.F. Stinson	Interval	5	C.F. Stinson	Swivel	6
			C.F. Stinson	Isabella	6	C.F. Stinson	Symmetry	6
			C.F. Stinson	Jam Session w/ Agion	7	C.F. Stinson	Thicket	4
			C.F. Stinson	Jambi Stripe	6	C.F. Stinson	Tracing	5
			C.F. Stinson	Jasmine Screen	6	C.F. Stinson	Transcend	3
			C.F. Stinson	Jump w/ Agion	7	C.F. Stinson	Tranquility	6
			C.F. Stinson	Knock Knock	7	C.F. Stinson	Tribeca	3
			C.F. Stinson	Labyrinth	6	C.F. Stinson	True Path w/ Agion	7
			C.F. Stinson	Leaps & Bounds	6	C.F. Stinson	Tweed	6
			C.F. Stinson	Lift	7	C.F. Stinson	Up Tempo w/ Agion	7
			C.F. Stinson	Lindley Park	3	C.F. Stinson	Urban Grid	3
			C.F. Stinson	Line Dance	5	C.F. Stinson	Vanish	7
			C.F. Stinson	Linus	5	C.F. Stinson	Vapor	6
			C.F. Stinson	Makeover	7	C.F. Stinson	Velocity	5
			C.F. Stinson	Manchester	5	C.F. Stinson	Vermont	6
			C.F. Stinson	Marimba	5	C.F. Stinson	Vibe	5
			C.F. Stinson	Mingle	6	C.F. Stinson	View	6
			C.F. Stinson	Montage	5	C.F. Stinson	Vintage	6
			C.F. Stinson	Nest	6	C.F. Stinson	Vision	4
			C.F. Stinson	New Hempstead	3	C.F. Stinson	Voltage	6
			C.F. Stinson	Next Scene	6	C.F. Stinson	Whirl	6
			C.F. Stinson	Nova	5	C.F. Stinson	Willow Talk	6
			C.F. Stinson	Now & Zen w/ Agion	7	C.F. Stinson	Wish	8

C.F. STINSON

Manufacturer	Pattern	Grade
C.F. Stinson	Ace	2
C.F. Stinson	Acrobat	6
C.F. Stinson	Adirondack	6
C.F. Stinson	Aero	5
C.F. Stinson	Alchemy	5
C.F. Stinson	Alfresco	6
C.F. Stinson	Alignment	6
C.F. Stinson	Aloha	6
C.F. Stinson	Arc	5
C.F. Stinson	Ascend	6
C.F. Stinson	Balance Beam	6
C.F. Stinson	Bali	6
C.F. Stinson	Bass Line	6
C.F. Stinson	Beatbox	6
C.F. Stinson	Beep Beep	6
C.F. Stinson	Bespoke	5
C.F. Stinson	Blip	3
C.F. Stinson	Block Party	6
C.F. Stinson	Bloom	8
C.F. Stinson	Bongo	6
C.F. Stinson	Breton	6
C.F. Stinson	Brilliant	4
C.F. Stinson	Bryant Park	3
C.F. Stinson	Calla	6
C.F. Stinson	Cannon Beach	7
C.F. Stinson	Catalina	6
C.F. Stinson	Catwalk	5
C.F. Stinson	Celeste	6
C.F. Stinson	Chauncey	5
C.F. Stinson	Chi w/ Agion®	7
C.F. Stinson	Chloe	5
C.F. Stinson	Cinnamon Blossom	6
C.F. Stinson	Coco	6
C.F. Stinson	Colden	6
C.F. Stinson	Comeback	7
C.F. Stinson	Concentric	6
C.F. Stinson	Continuum	5
C.F. Stinson	Cottonwood	5
C.F. Stinson	Courtyard	6
C.F. Stinson	Cozy	5
C.F. Stinson	Cruisin'	6
C.F. Stinson	Crypton Metro	5
C.F. Stinson	Crypton Suede	5
C.F. Stinson	Crystalline	6
C.F. Stinson	Current	7
C.F. Stinson	Curves Ahead	6
C.F. Stinson	Daddy-0 w/ Agion	7
C.F. Stinson	Dart	4

Graded In Fabrics

Manufacturer	Pattern	Grade	Manufacturer	Pattern	Grade	Manufacturer	Pattern	Grade
C.F. Stinson	Zoom	5	Designtex	Astrid	5	Designtex	Ellipsis	3
C.F. Stinson	Chakra	7	Designtex	Banda	6	Designtex	Eon	6
C.F. Stinson	Deza	7	Designtex	Baratto	7	Designtex	Epiphany	6
C.F. Stinson	Jala	7	Designtex	Barque	Call	Designtex	Essence	3
C.F. Stinson	Kambala	7	Designtex	Basketry	Call	Designtex	Exmouth	Call
C.F. Stinson	Ketana	7	Designtex	Battista	8	Designtex	Faux Sure	6
C.F. Stinson	Varati	7	Designtex	Bee	5	Designtex	Florin	5
C.F. Stinson	Grove	6	Designtex	Beetled Linen	8	Designtex	Flux	6
C.F. Stinson	Panorama	6	Designtex	Beguiled By The Wild	6	Designtex	Fortuna	8
C.F. Stinson	Sunswept	6	Designtex	Big Dot	6	Designtex	Friendly Faux	6
C.F. Stinson	Tuscan Hills	7	Designtex	Billiard Cloth Standard	6	Designtex	Fuse	6
C.F. Stinson	Umbrian Rain	7	Designtex	Birch Bark Plaid	7	Designtex	Gale	5
C.F. Stinson	Vineyard	7	Designtex	Bit	5	Designtex	Gallone	6
C.F. Stinson	Aura	7	Designtex	Block Print	7	Designtex	Gamut	3
C.F. Stinson	Lucent	7	Designtex	Bolt	6	Designtex	Glaze	6
C.F. Stinson	Radiance	7	Designtex	Bordo	6	Designtex	Gleam	6
C.F. Stinson	Spark	7	Designtex	Botanique	5	Designtex	Gradate	6
C.F. Stinson	Acanthus	7	Designtex	Boucle	6	Designtex	Gramercy	Call
C.F. Stinson	Algiers	7	Designtex	Boucle Two-Tone	5	Designtex	Grandeur	5
C.F. Stinson	Balustrade	7	Designtex	Bounce	6	Designtex	Griglia	6
C.F. Stinson	Canterbury	7	Designtex	Breena	5	Designtex	Hashtag	5
C.F. Stinson	Cyma	7	Designtex	Bunta	5	Designtex	Heather	7
C.F. Stinson	Delphi	6	Designtex	Caiman	5	Designtex	Hem Stitch	5
C.F. Stinson	Diffusion	7	Designtex	Cascadia	5	Designtex	Henrietta	9
C.F. Stinson	Impression	7	Designtex	Cassava	6	Designtex	Henrik Large	7
C.F. Stinson	Links	6	Designtex	Catalyst	5	Designtex	Henrik Small	7
C.F. Stinson	Mali	6	Designtex	Cestino	7	Designtex	Hexstripe	6
C.F. Stinson	Malta	7	Designtex	Chapiteau	5	Designtex	Holmes	7
C.F. Stinson	Mumbai	7	Designtex	Checker Stripe	9	Designtex	Honor Plus	8
C.F. Stinson	Oscillate	7	Designtex	Chevron	Call	Designtex	Horizon	7
C.F. Stinson	Scintillate	6	Designtex	Chromatic	5	Designtex	Houndstooth Plaid	Call
C.F. Stinson	Spindles	7	Designtex	Circa	6	Designtex	Hyphen	5
C.F. Stinson	Stratford	8	Designtex	Circolo	6	Designtex	Inertia	7
C.F. Stinson	Tessellate	7	Designtex	Circumference	8	Designtex	Inga Large	7
			Designtex	Claire	9	Designtex	Inga Small	7
			Designtex	Clerkenwell	Call	Designtex	Inkling	6
			Designtex	Closed Loop	5	Designtex	Inlet	5
			Designtex	Cobble	Call	Designtex	Inside Edge	6
			Designtex	Colorblock	6	Designtex	Interlock	6
			Designtex	Colorful Plaid	5	Designtex	Introvert	5
			Designtex	Concept	6	Designtex	Irregular Grid	5
			Designtex	Converge	6	Designtex	Isometry	7
			Designtex	Cross Court	7	Designtex	Isotope	6
			Designtex	Crosshatch	6	Designtex	Jaunt	7
			Designtex	Crossweave	5	Designtex	Journey	9
			Designtex	Crosswind	5	Designtex	Kabuki	6
			Designtex	Culebra	9	Designtex	Kalahari	5
			Designtex	Current	5	Designtex	Kanthas	Call
			Designtex	Cusco	9	Designtex	Klange	6
			Designtex	Cut & Paste	7	Designtex	Komposition	6
			Designtex	Dahlia	7	Designtex	Lambert	7
			Designtex	Dart	6	Designtex	Lattice	7
			Designtex	Dashing	5	Designtex	Leaf Dot	6
			Designtex	Delaine	6	Designtex	Leafette	5
			Designtex	Dharma Stripe	5	Designtex	Leap	5
			Designtex	Dichotomy	8	Designtex	Leaves	6
			Designtex	Dot To Dot	7	Designtex	Leland	5
			Designtex	Draft	6	Designtex	Linari	5
			Designtex	Eastside	6	Designtex	Lindos	6

DESIGNTEX		
Manufacturer	Pattern	Grade
Designtex	Acacia	6
Designtex	Adler	5
Designtex	Aggregate	6
Designtex	Ainsley	8
Designtex	Aksel	6
Designtex	Alcazar	5
Designtex	Alchemy	5
Designtex	Aleman	6
Designtex	Alistair	6
Designtex	Alpine	5
Designtex	Amaranth	6
Designtex	Amuse	7
Designtex	Amwell	Call
Designtex	Annex	5
Designtex	Appleseed	6
Designtex	Argiano	5
Designtex	Array	9
Designtex	Arthur	9
Designtex	Aster	8

Manufacturer	Pattern	Grade	Manufacturer	Pattern	Grade	Manufacturer	Pattern	Grade
Designtex	Lioret	5	Designtex	Restore	5	Designtex	Tweed Multi	5
Designtex	Little Dot	6	Designtex	Reuse	7	Designtex	Urban Grid	6
Designtex	Little Plaid	5	Designtex	Rice	6	Designtex	Valanka	7
Designtex	Lofty	5	Designtex	Rio Grande	6	Designtex	Valet	5
Designtex	Lolland	9	Designtex	Rivergrass	5	Designtex	Variant	8
Designtex	Loop To Loop	8	Designtex	Rivet	5	Designtex	Versed	5
Designtex	Lorien	7	Designtex	Rivet Pearl	5	Designtex	Vivid	4
Designtex	Ludington	4	Designtex	Rocket	4	Designtex	Volley	7
Designtex	Luster	6	Designtex	Rosario	9	Designtex	Vox	6
Designtex	Lydia	9	Designtex	Rotary	7	Designtex	W	6
Designtex	Maglia	7	Designtex	Rothsay	7	Designtex	Westside	7
Designtex	Majolica	8	Designtex	Rough & Ready II	6	Designtex	Whim	5
Designtex	Mandala	6	Designtex	Round Leaves	7	Designtex	Windowpane	5
Designtex	Margin	9	Designtex	Rume	6	Designtex	Winsome	5
Designtex	Match Point	7	Designtex	Rumeli	5	Designtex	Wire	8
Designtex	Melange	5	Designtex	Samba	7	Designtex	Woodcut	6
Designtex	Melrose	Call	Designtex	Samba Otra Vez	7	Designtex	Wren	4
Designtex	Metamorphosis	8	Designtex	Saugatuck	5	Designtex	Yoruba	6
Designtex	Metta	5	Designtex	Savile Plaid	8	Designtex	Yucca	6
Designtex	Microgrid	5	Designtex	See Saw	7	Designtex	Zhuba	5
Designtex	Migration	8	Designtex	Seed	6	Designtex	Zocalo	7
Designtex	Mingle	6	Designtex	Sequence	6			
Designtex	Mod	7	Designtex	Sett	8			
Designtex	Modern Tweed	9	Designtex	Shibori Stripe	6			
Designtex	Moderne	7	Designtex	Shimmering Tide	8			
Designtex	Mohair Plus	Call	Designtex	Signal	7			
Designtex	Motif	6	Designtex	Skye	8			
Designtex	Myddleton	Call	Designtex	Sorano	5			
Designtex	New Selkirk	8	Designtex	Spandau	5			
Designtex	Nexus	6	Designtex	Spiro	6			
Designtex	Noble	5	Designtex	Splendor	5			
Designtex	Nonchalant	5	Designtex	Stacks	7			
Designtex	Notion	6	Designtex	Starburst	7			
Designtex	Omar	5	Designtex	Steppe	5			
Designtex	Ophidian	5	Designtex	Striae	5			
Designtex	Opulent	5	Designtex	Sugar Shoots	6			
Designtex	Oscillate	6	Designtex	Sunburst	8			
Designtex	Oxford Stripe	7	Designtex	Sunburst	8			
Designtex	Palomino	5	Designtex	Swayed	Call			
Designtex	Parga	5	Designtex	Swing	7			
Designtex	Pennington	7	Designtex	Swing Set	7			
Designtex	Phase	5	Designtex	Synthesis	6			
Designtex	Pigment	7	Designtex	Tack Cloth	6			
Designtex	Piiki	7	Designtex	Tarascon	5			
Designtex	Pika	5	Designtex	Terrain	6			
Designtex	Pinball	7	Designtex	Tessellate	8			
Designtex	Pivot	5	Designtex	Tetris	7			
Designtex	Pleat	6	Designtex	The Last Aphid	7			
Designtex	Pop Art	6	Designtex	Tinos	6			
Designtex	Porte	5	Designtex	Tiny Herringbone	6			
Designtex	Posey	7	Designtex	Titanium	8			
Designtex	Prairie	5	Designtex	To The Point	5			
Designtex	Precision	5	Designtex	Tomolo	5			
Designtex	Prime	4	Designtex	Top Spin	7			
Designtex	Quintessence	7	Designtex	Trace	Call			
Designtex	Radar	6	Designtex	Tramway	6			
Designtex	Rail	6	Designtex	Transport	7			
Designtex	Razor Stripe	7	Designtex	Travertine	5			
Designtex	Refine	5	Designtex	Tumble Stones	8			
			Designtex	Tumbleweed	6			

GUILFORD OF MAINE		
Manufacturer	Pattern	Grade
Guilford of Maine	Anchorage	2
Guilford of Maine	Aurora	5
Guilford of Maine	Beacon	2
Guilford of Maine	BeeHave	2
Guilford of Maine	Brook	5
Guilford of Maine	Chalet	5
Guilford of Maine	Echo	3
Guilford of Maine	Frolic	2
Guilford of Maine	Harvest	5
Guilford of Maine	Highbeams	2
Guilford of Maine	Hush	5
Guilford of Maine	Jane	2
Guilford of Maine	Jane	2
Guilford of Maine	Lifesaver	2
Guilford of Maine	Madison	2
Guilford of Maine	Moguls	3
Guilford of Maine	Napa	5
Guilford of Maine	Open House	2
Guilford of Maine	Open House	2
Guilford of Maine	Pirouette	5
Guilford of Maine	Punchline	2
Guilford of Maine	Reef	5
Guilford of Maine	River Rock	5
Guilford of Maine	Rock Star	4
Guilford of Maine	Sand Dollar	5
Guilford of Maine	Sedona	5
Guilford of Maine	Snakeskin	2
Guilford of Maine	Soundbyte	2
Guilford of Maine	Surf	5
Guilford of Maine	Telegraph	3
Guilford of Maine	Trellis	5
Guilford of Maine	Whirl	2

Graded In Fabrics

KNOLL			Manufacturer	Pattern	Grade	Manufacturer	Pattern	Grade
Manufacturer	Pattern	Grade	Knoll	Firefly	7	Knoll	Noble	5
Knoll	Abacus	5	Knoll	Foil Rap	5	Knoll	Nonchalant CR	5
Knoll	Alignment	5	Knoll	Forza	5	Knoll	Origins	5
Knoll	Arabella	1	Knoll	Fox Trot CR	6	Knoll	Palisade	5
Knoll	Argyle	4	Knoll	Framework	5	Knoll	Panache CR	6
Knoll	Arno	9	Knoll	Gala II	5	Knoll	Paradigm	6
Knoll	Aswan	8	Knoll	Gibson	8	Knoll	Petal Pusher	4
Knoll	Atelier	7	Knoll	Glider	6	Knoll	Pogo	6
Knoll	Atlas	6	Knoll	Grande	5	Knoll	Prairie	3
Knoll	Axiom	5	Knoll	Grandview	5	Knoll	Prep	5
Knoll	Bank Shot	6	Knoll	Greenwich	5	Knoll	Presto	3
Knoll	Baxter	5	Knoll	Haze	8	Knoll	Prim	4
Knoll	Beacon	2	Knoll	Heavy Metal	5	Knoll	Quark	7
Knoll	Belize	5	Knoll	Highland	6	Knoll	Radiance	5
Knoll	Biota	6	Knoll	Holbrook	4	Knoll	Ransom	5
Knoll	Biscayne	6	Knoll	Hologram	6	Knoll	Regard CR	6
Knoll	Bistro	4	Knoll	Honour	Call	Knoll	Ricochet	5
Knoll	Bocce	4	Knoll	Hourglass	3	Knoll	Rivington	7
Knoll	Bollywood	5	Knoll	Hudson	5	Knoll	Roam	5
Knoll	Boundary	4	Knoll	Hula Hoop	6	Knoll	Roundtrip	6
Knoll	Cairo	5	Knoll	Icon	8	Knoll	Rush Hour	4
Knoll	Calais Cotton Velvet	8	Knoll	Ikat Square	6	Knoll	Sahara	6
Knoll	Cameo	6	Knoll	Ikat Stripe	6	Knoll	Sandpiper CR	6
Knoll	Cato	Call	Knoll	Improv	4	Knoll	Sequin CR	6
Knoll	Cats Cradle	4	Knoll	Intrigue	6	Knoll	Serendipity	7
Knoll	Century	7	Knoll	Island	5	Knoll	Sherman	6
Knoll	Chance	3	Knoll	Journey	4	Knoll	Shima	7
Knoll	Charm	6	Knoll	Kampala	6	Knoll	Sinclair	5
Knoll	Chroma	5	Knoll	Katazome	6	Knoll	Smart	5
Knoll	Chronicle	5	Knoll	Keaton	4	Knoll	Soiree	5
Knoll	Circa	6	Knoll	Kimono	7	Knoll	Soliloquy	2
Knoll	Classic Boucle	6	Knoll	Kinabalu	7	Knoll	Sonnet	3
Knoll	Close Knit	5	Knoll	Kingston	7	Knoll	Soon	6
Knoll	Coco	8	Knoll	Knoll Felt	5	Knoll	Spark	5
Knoll	Common Ground	5	Knoll	Knoll Hopsack	5	Knoll	Spectator	6
Knoll	Commuter Cloth	2	Knoll	Knoll Velvet	Call	Knoll	Spencer	9
Knoll	Compass CR	6	Knoll	Kora CR	6	Knoll	Spot On	6
Knoll	Constance	1	Knoll	Lagos	5	Knoll	Spree	5
Knoll	Cornaro	8	Knoll	Legend CR	6	Knoll	Stacks	4
Knoll	Coterie	6	Knoll	Liberty	6	Knoll	Star Struck	6
Knoll	Dahlia CR	5	Knoll	Lore CR	6	Knoll	Stepping Stones	6
Knoll	Decobeat	5	Knoll	Ludlow	4	Knoll	Striae Stripe	7
Knoll	Delite	2	Knoll	Lytic	6	Knoll	Summit	4
Knoll	Diamond Days	1	Knoll	Magnolia	5	Knoll	Sutton	4
Knoll	Diva	4	Knoll	Mamba	8	Knoll	Swing	6
Knoll	Djenne	7	Knoll	Mariner	5	Knoll	Synth	4
Knoll	Dovetail	5	Knoll	Marquee	6	Knoll	Theory	5
Knoll	Dristi	5	Knoll	Masquerade	6	Knoll	Tight Rope	5
Knoll	Dune	5	Knoll	Melange	7	Knoll	Tilden	5
Knoll	Durand	5	Knoll	Melody	4	Knoll	Tinge	4
Knoll	Dynamic	Call	Knoll	Menagerie	6	Knoll	Topography	8
Knoll	Earthwork	6	Knoll	Meroe	6	Knoll	Totem	7
Knoll	Eclat Weave	7	Knoll	Metro	6	Knoll	Tower Grid	5
Knoll	Empire Stripe	6	Knoll	Milestone	5	Knoll	Treble CR	6
Knoll	Entourage	5	Knoll	Mini Stitch	5	Knoll	Trophy	3
Knoll	Essence	5	Knoll	Mod Plaid	7	Knoll	Tryst	7
Knoll	Fable CR	6	Knoll	Monarch	5	Knoll	Tweed Frieze	8
Knoll	Ferry	4	Knoll	Moto CR	6	Knoll	Ultrasuede	8
Knoll	Fibra	7	Knoll	Night Life	6	Knoll	Una	9

Manufacturer	Pattern	Grade
Knoll	Utmost	6
Knoll	Utrillo	7
Knoll	Venue	4
Knoll	Versa	4
Knoll	Vibe	5
Knoll	Vinyl	5
Knoll	Westwood	4
Knoll	Whip	6
Knoll	Wide Angle	6
Knoll	Wit	5
Knoll	Woodland	5
Knoll	Zari CR	6
Knoll	Zipline	5
Knoll	Zoom	7

LUNA

Manufacturer	Pattern	Grade
Luna	Allegra	8
Luna	Allure	9
Luna	Amuse	6
Luna	Beam	8
Luna	Betwixt	6
Luna	Boink	7
Luna	Boucle Stripe	7
Luna	Burst	7
Luna	Charm	9
Luna	Cloud	8
Luna	Cozy	Call
Luna	Dapple	7
Luna	Delight	6
Luna	Dimension Mohair	Call
Luna	Dish	5
Luna	Doodad	8
Luna	Dots Damask	4
Luna	Downtown Two	5
Luna	Eclipse 54	6
Luna	Embarcadero	Call
Luna	Enchant	8
Luna	Ensemble	9
Luna	Esperanto	8
Luna	Filament	7
Luna	Flare	8
Luna	Flash	7
Luna	Gizmo	8
Luna	Hardcopy	5
Luna	Hardware	8
Luna	Hatch	8
Luna	Hatch Too	5
Luna	Hush	6
Luna	Jaunty	6
Luna	Luna Atelier 01 (LA01)	8
Luna	Matchsticks	6
Luna	Mezzanine	5
Luna	Micro Bubbly	9
Luna	Mobile	7
Luna	Motif.	7

Manufacturer	Pattern	Grade
Luna	Nifty	4
Luna	Notion	5
Luna	Peek	8
Luna	Plaza	5
Luna	Propeller	9
Luna	Redfern	9
Luna	Redondo	8
Luna	Sketch Stripe	8
Luna	Snug	Call
Luna	Sparkle	5
Luna	Spellbound	9
Luna	Splice	5
Luna	Staccato	8
Luna	Stacking Chairs	6
Luna	Stars	6
Luna	Tech Stripe	8
Luna	Telepathy	7
Luna	Trapeze	4
Luna	Urban Grid	8
Luna	Waffle	5
Luna	Wallflower	5
Luna	Whimsy	5
Luna	Winsome	Call
Luna	Wish	6

MAHARAM

Manufacturer	Pattern	Grade
Maharam	A Band Apart	Call
Maharam	Abacus	6
Maharam	Abacus Standard	5
Maharam	Acre	6
Maharam	Across	6
Maharam	Aftermath	Call
Maharam	Agency	Call
Maharam	Akimbo	6
Maharam	Align	6
Maharam	Alloy	5
Maharam	Alpaca Epingle	Call
Maharam	Alpaca Herringbone	Call
Maharam	Alpaca Velvet	Call
Maharam	Alter	5
Maharam	Anagram	7
Maharam	Arabesque	9
Maharam	Aria	9
Maharam	Array	5
Maharam	Article	5
Maharam	Balustrade	6
Maharam	Banister	6
Maharam	Bar	5
Maharam	Bar Crypton	6
Maharam	Basel by Kvadrat	6
Maharam	Bavaria	Call
Maharam	Bavaria Stripe	Call
Maharam	Beam	6
Maharam	Before	5
Maharam	Beside	6

Manufacturer	Pattern	Grade
Maharam	Bespoke Stripe	Call
Maharam	Bevel	5
Maharam	Big Stripe	Call
Maharam	Bitmap	5
Maharam	Blip	6
Maharam	Blocks	Call
Maharam	Blumen	9
Maharam	Borders	Call
Maharam	Bound	5
Maharam	Boundary	5
Maharam	Bridge	5
Maharam	Bright Angle	8
Maharam	Bright Cube	8
Maharam	Bright Grid	8
Maharam	Brushed Camel	Call
Maharam	Brushed Cashmere	Call
Maharam	Brushed Merino	Call
Maharam	Candid	5
Maharam	Canvas by Kvadrat	6
Maharam	Carapace	9
Maharam	Cartouche	6
Maharam	Cashmere Ripple	Call
Maharam	Centric	7
Maharam	Certain	6
Maharam	Chalet	6
Maharam	Chance	6
Maharam	Checker	9
Maharam	Checker Split	9
Maharam	Chenille Cord	7
Maharam	Chenille Stripe	Call
Maharam	Chime	5
Maharam	Chock	6
Maharam	Chroma	Call
Maharam	Cinch	5
Maharam	Cipher	7
Maharam	Circles	9
Maharam	Circuit	6
Maharam	Climb	7
Maharam	Coach Cloth	Call
Maharam	Cobblestone	Call
Maharam	Coda by Kvadrat	9
Maharam	Coin	5
Maharam	Coin Crypton	6
Maharam	Coincide	5
Maharam	Coincide High Performance	6
Maharam	Colline by Kvadrat	6
Maharam	Colorfield	Call
Maharam	Colorwheel	8
Maharam	Column	6
Maharam	Commentary	6
Maharam	Compartment	Call
Maharam	Compound	6
Maharam	Confetti	8
Maharam	Cotton Velvet	Call
Maharam	Couple	6
Maharam	Cover	5
Maharam	Crew	6
Maharam	Crosspatch	9
Maharam	Crush	6

Graded In Fabrics

Manufacturer	Pattern	Grade	Manufacturer	Pattern	Grade	Manufacturer	Pattern	Grade
Maharam	Cursive	7	Maharam	Industry	Call	Maharam	Parched Silk	Call
Maharam	Cycle	5	Maharam	Insignia	7	Maharam	Park	8
Maharam	Dapper	5	Maharam	Jacobs Coat	Call	Maharam	Pavement	9
Maharam	Dart	6	Maharam	Kindred	6	Maharam	Paver	6
Maharam	Dash	5	Maharam	Knob	Call	Maharam	Pebble Wool	Call
Maharam	Decode	6	Maharam	Knot	9	Maharam	Pebble Wool Multi	Call
Maharam	Deconstructed Rose	Call	Maharam	Lanalux	Call	Maharam	Pennant	6
Maharam	Defer	5	Maharam	Lariat	5	Maharam	Periphery	9
Maharam	Design 9297	9	Maharam	Latch	7	Maharam	Pick	5
Maharam	Dingbats	9	Maharam	Layers Garden	Call	Maharam	Pick Crypton	6
Maharam	Disc	5	Maharam	Layers Garden Double	Call	Maharam	Pitch	5
Maharam	Disc Crypton	6	Maharam	Layers Park	Call	Maharam	Plait	5
Maharam	Disperse	6	Maharam	Layers Park Double	Call	Maharam	Plait High Performance	6
Maharam	Ditto	6	Maharam	Layers Vineyard Large	Call	Maharam	Plural	9
Maharam	Divide	5	Maharam	Layers Vineyard Small	Call	Maharam	Ply Mesh Black/Tan	Call
Maharam	Divide Crypton	6	Maharam	Ledger	5	Maharam	Pocket	6
Maharam	Divina by Kvadrat	7	Maharam	Lens	5	Maharam	Point	Call
Maharam	Divina MD by Kvadrat	7	Maharam	Letters	Call	Maharam	Pressed Plaid	Call
Maharam	Divina Melange by Kvadrat	7	Maharam	Lift	7	Maharam	Quatrefoil	9
Maharam	Division	5	Maharam	Lineage	5	Maharam	Quick	5
Maharam	Dot Pattern	9	Maharam	Link	7	Maharam	Radiant	8
Maharam	Double Triangles	9	Maharam	Linomix	Call	Maharam	Recollection	6
Maharam	Drape	6	Maharam	Manner	4	Maharam	Reef	8
Maharam	Eden	Call	Maharam	Marquee	5	Maharam	Reel	7
Maharam	Ellipsis	6	Maharam	Massive Paisley	Call	Maharam	Regatta	6
Maharam	Emblem	6	Maharam	Matrix by Kvadrat	7	Maharam	Remix by Kvadrat	6
Maharam	Emboss	6	Maharam	Meander	6	Maharam	Repeat Classic	Call
Maharam	Enmesh	5	Maharam	Mechanism	8	Maharam	Repeat Classic Print	Call
Maharam	Epingle Stripe	Call	Maharam	Medium	5	Maharam	Repeat Classic Stripe	Call
Maharam	Exaggerated Plaid	Call	Maharam	Melange Tweed	Call	Maharam	Repeat Dot	Call
Maharam	Exchange	5	Maharam	Memory by Kvadrat	7	Maharam	Repeat Dot Print	Call
Maharam	Facets	9	Maharam	Meridian	6	Maharam	Repeat Dot Ring	Call
Maharam	Fasten	6	Maharam	Messenger	4	Maharam	Ring	5
Maharam	Fathom	5	Maharam	Metric	5	Maharam	Rise	6
Maharam	Feature	6	Maharam	Micro	5	Maharam	Rove	5
Maharam	Fiddle	6	Maharam	Mikado	9	Maharam	Rubric	6
Maharam	Floret	6	Maharam	Milestone	4	Maharam	Rule	6
Maharam	Fluent Crypton	6	Maharam	Millerstripe	Call	Maharam	Runner	6
Maharam	Fluted Silk	9	Maharam	Mimic	7	Maharam	Runner Standard	5
Maharam	Focus	5	Maharam	Mineral	6	Maharam	Salon	8
Maharam	Fold	6	Maharam	Minicheck	9	Maharam	Schema	6
Maharam	Foliage	Call	Maharam	Minimal	6	Maharam	Scout	6
Maharam	Fraction	6	Maharam	Mister	6	Maharam	Scuba	5
Maharam	Fruit	9	Maharam	Mode	5	Maharam	Seam	5
Maharam	Garden	8	Maharam	Mohair Extreme	Call	Maharam	Sequence	6
Maharam	Geometri	9	Maharam	Mohair Supreme	Call	Maharam	Shadowbox	6
Maharam	Grade	7	Maharam	Monk's Wool	Call	Maharam	Sheen	6
Maharam	Grid	Call	Maharam	Mortise	6	Maharam	Shuttle	6
Maharam	Hallingdal by Kvadrat	7	Maharam	Names	9	Maharam	Shuttle Standard	5
Maharam	Hedge	6	Maharam	Oblique	5	Maharam	Signal	6
Maharam	Helix	7	Maharam	Octave	6	Maharam	Silk Canvas	9
Maharam	Hero by Kvadrat	6	Maharam	Offset	7	Maharam	Skein	5
Maharam	Herringbone Stripe	Call	Maharam	Omen	6	Maharam	Small Dot Pattern	9
Maharam	Highfield by Kvadrat	7	Maharam	Optik	9	Maharam	Snap	8
Maharam	Horsehair Basket	Call	Maharam	Orakelblume	9	Maharam	Soft Tweed	9
Maharam	Horsehair Check	Call	Maharam	Ottoman Stripe	Call	Maharam	Sort	5
Maharam	Horsehair Striae	Call	Maharam	Outback by Kvadrat	7	Maharam	Stack	5
Maharam	Houndstooth	9	Maharam	Painted Stripe	Call	Maharam	Star by Kvadrat	7
Maharam	Hours	Call	Maharam	Palio	9	Maharam	Stature	5

Manufacturer	Pattern	Grade	MAYER			Manufacturer	Pattern	Grade
Maharam	Steady	5	Manufacturer	Pattern	Grade	Mayer	Cuddle Up	5
Maharam	Steady Crypton	6	Mayer	Acclaim	4	Mayer	Curlicue	3
Maharam	Steelcut by Kvadrat	6	Mayer	Align	3	Mayer	Dakota	4
Maharam	Steelcut Trio by Kvadrat	7	Mayer	All Seasons FR	3	Mayer	Dande	3
Maharam	Strand	6	Mayer	All Use FR	2	Mayer	Dapper	2
Maharam	Stride	5	Mayer	Amadeus	5	Mayer	Daydream	4
Maharam	Stripes	Call	Mayer	Anasazi	3	Mayer	Dazzle	5
Maharam	Strum	6	Mayer	Antique	4	Mayer	Debonair	5
Maharam	Study	7	Mayer	Apex	3	Mayer	Debut	6
Maharam	Sudden	6	Mayer	Arabesque	5	Mayer	Destiny	4
Maharam	Superweave	Call	Mayer	Aristocrat	5	Mayer	Destiny plus DuraBlock™	5
Maharam	Surge	6	Mayer	Array	5	Mayer	Detail	5
Maharam	Tailor	5	Mayer	Artistry	2	Mayer	Disco	5
Maharam	Tally	6	Mayer	Ascension	6	Mayer	Domain	5
Maharam	Tandem	5	Mayer	Athens FR	4	Mayer	Dublin Tweed FR	4
Maharam	Tangram	8	Mayer	Atomic	3	Mayer	Durango	3
Maharam	Teatro	7	Mayer	Aurora	6	Mayer	Duraweave® 10	2
Maharam	Technic	5	Mayer	Avenue	5	Mayer	Echo	4
Maharam	Telary	8	Mayer	Awakening	7	Mayer	Ecosphere	5
Maharam	Terrace	6	Mayer	Banner	2	Mayer	Eleanor Rigby	5
Maharam	The Firm	Call	Mayer	Bar None	5	Mayer	Element	3
Maharam	The Story of My Life	Call	Mayer	Basic	1	Mayer	Empire	7
Maharam	Ticker	6	Mayer	Batik	3	Mayer	Emu	2
Maharam	Tilt	6	Mayer	BeBop	5	Mayer	Encore	6
Maharam	Tokyo by Kvadrat	8	Mayer	Bella	5	Mayer	Enigma	6
Maharam	Tonica by Kvadrat	6	Mayer	Berkshire	5	Mayer	Entourage	6
Maharam	Tonus by Kvadrat	6	Mayer	Big Top	5	Mayer	Entwine	3
Maharam	Tonus Meadow by Kvadrat	6	Mayer	Blocks	3	Mayer	Equal	2
Maharam	Toostripe	Call	Mayer	Bolero	5	Mayer	Equation	4
Maharam	Trait	6	Mayer	Botanica	5	Mayer	Equinox	4
Maharam	Transport	9	Mayer	Boteh	7	Mayer	Erode	6
Maharam	Tread	6	Mayer	Brio	5	Mayer	Escapade	6
Maharam	Treat	6	Mayer	Bungalow	5	Mayer	Esprit	5
Maharam	Trees	8	Mayer	Burst	5	Mayer	Essex	4
Maharam	Trellis	6	Mayer	Camelot	4	Mayer	Europa	5
Maharam	Tremor	6	Mayer	Canvas	5	Mayer	Evolve	6
Maharam	Trio	7	Mayer	Caressa FR	3	Mayer	Fable	5
Maharam	Turn	6	Mayer	Caressa Suede	4	Mayer	Facets	6
Maharam	Twice	5	Mayer	Cascade	5	Mayer	Factor	4
Maharam	Twine	6	Mayer	Catalyst	4	Mayer	Fairy Tales	6
Maharam	Unisol	9	Mayer	Cavalier	2	Mayer	FanFare	6
Maharam	Urban	6	Mayer	Cayman	5	Mayer	Fantasy	6
Maharam	Vary	5	Mayer	Celtic	5	Mayer	Fathom	5
Maharam	Vases	8	Mayer	Chaps FR	4	Mayer	Figure Eight	3
Maharam	Velvet Stripe	Call	Mayer	Charade	5	Mayer	Finale	5
Maharam	Venn	6	Mayer	Charette	3	Mayer	Finesse	3
Maharam	Vestige	6	Mayer	Circuit	6	Mayer	Finish Line	5
Maharam	Vineyard	8	Mayer	Circumference	6	Mayer	Flock	6
Maharam	Voyage	9	Mayer	City Lights	5	Mayer	Florentino	2
Maharam	Waterborn by Kvadrat	Call	Mayer	Collage	6	Mayer	Flower Power	3
Maharam	Waxen	5	Mayer	Component	4	Mayer	Focal Point	3
Maharam	Wedge	6	Mayer	Contempo	3	Mayer	Formations	3
Maharam	Weimar	7	Mayer	Continuum	2	Mayer	Forte	1
Maharam	Whirl	5	Mayer	Convergence	6	Mayer	Foundation 10	2
Maharam	Wool Rib	9	Mayer	Copa	2	Mayer	Frequency	6
Maharam	Wool Striae	Call	Mayer	Cork	5	Mayer	Fresco	2
Maharam	Wool Velvet	Call	Mayer	Counterpoint	5	Mayer	Gala	5
Maharam	Wrap	5	Mayer	Cross Check	1	Mayer	Geisha	7
			Mayer	Crystals	5	Mayer	Genesis	3

Graded In Fabrics

Manufacturer	Pattern	Grade	Manufacturer	Pattern	Grade	Manufacturer	Pattern	Grade
Mayer	Genesis plus DuraBlock™	5	Mayer	Moonscape	3	Mayer	Reiki	6
Mayer	Glee	4	Mayer	Mosaic	3	Mayer	Relic	6
Mayer	Glimmer	5	Mayer	Mosaic plus DuraBlock™	5	Mayer	Replay	5
Mayer	Grasscloth	2	Mayer	Motif	5	Mayer	Reveal	5
Mayer	Groundworks	5	Mayer	Multi-Crepe	2	Mayer	Reverb	3
Mayer	Guardian	4	Mayer	Myriad	5	Mayer	Rhythm	6
Mayer	Haberdash	3	Mayer	Mystic	4	Mayer	Rift	5
Mayer	Habitat	5	Mayer	New Dimensions	7	Mayer	Ritz	4
Mayer	Heather FR	4	Mayer	Nexus	2	Mayer	Rock & Roll	5
Mayer	Hole In One	5	Mayer	Nirvana	5	Mayer	Round 'N Round	6
Mayer	Holiday	5	Mayer	Nostalgia	5	Mayer	Sakura	6
Mayer	Hombre	5	Mayer	Nuance	5	Mayer	Samurai	6
Mayer	Hoopla	3	Mayer	Nylon-Stat ESD	5	Mayer	Sashiko	6
Mayer	Hopsack	5	Mayer	Obi	6	Mayer	Sequel	2
Mayer	Illusion	6	Mayer	Obsession	6	Mayer	Sequel plus DuraBlock™	4
Mayer	Images	3	Mayer	On the Spot	5	Mayer	Sequence	3
Mayer	Impulse	4	Mayer	Optic	2	Mayer	Shantung	3
Mayer	In The Groove	5	Mayer	Orbit	4	Mayer	Sherlock	3
Mayer	Infinity	5	Mayer	Origami	6	Mayer	Shibori	6
Mayer	Interlace	4	Mayer	Origin	3	Mayer	Shimmer	5
Mayer	Interlochen	4	Mayer	Ottoman	5	Mayer	Sierra SP Black	1
Mayer	Interlude	2	Mayer	Outback	3	Mayer	Silk Screen	4
Mayer	Intrigue	3	Mayer	Ovation	3	Mayer	SilverWeave	4
Mayer	Jekyll & Hyde**	4	Mayer	Oxen SP Black	1	Mayer	Skate	5
Mayer	Jenga	5	Mayer	Palermo	5	Mayer	Sketch	3
Mayer	Jitterbug	5	Mayer	Panache	6	Mayer	Slick	4
Mayer	Journey	5	Mayer	Paparazzi	6	Mayer	Smart Suede	5
Mayer	Jubilee	3	Mayer	Paradigm	6	Mayer	Social Network	5
Mayer	Juncture	7	Mayer	Paradise	6	Mayer	Solaris	5
Mayer	Karma	5	Mayer	Paragon	3	Mayer	Soleil	6
Mayer	Katagami	6	Mayer	Pastime	5	Mayer	Solid Ground	5
Mayer	Key Largo	3	Mayer	Patent	5	Mayer	Sophisticate	4
Mayer	Kismet	5	Mayer	Pathway	5	Mayer	Source	3
Mayer	Kobe	2	Mayer	Patio	3	Mayer	Source plus DuraBlock™	5
Mayer	Komodo	3	Mayer	Pavilion	6	Mayer	Space Odyssey	3
Mayer	Laredo	5	Mayer	Pebble Beach	2	Mayer	Spacer Mesh	2
Mayer	Linen	3	Mayer	Peerless	4	Mayer	Spectre	3
Mayer	Links	4	Mayer	Phoenix	3	Mayer	Spirograph	5
Mayer	Locomotion	3	Mayer	Pick Up Sticks	3	Mayer	Spotlight	5
Mayer	Longhorn	5	Mayer	Pinehurst	4	Mayer	Stanza	5
Mayer	Luminary	2	Mayer	Pinnacle	4	Mayer	Stardust	3
Mayer	Lunar	4	Mayer	Plaza	5	Mayer	Stop & Go	5
Mayer	Madras	4	Mayer	Portal	5	Mayer	Strata	1
Mayer	Madrid SP Black	1	Mayer	Positive Thoughts	6	Mayer	Stratosphere	7
Mayer	Makore	5	Mayer	Prado	4	Mayer	Suede	5
Mayer	Malibu	5	Mayer	Primo	5	Mayer	Swank	6
Mayer	Mandala	7	Mayer	Prism	2	Mayer	Synapse	6
Mayer	Marquise	3	Mayer	Pulse	6	Mayer	Tangled Web	6
Mayer	Marvel	5	Mayer	Punch	3	Mayer	Tangram	7
Mayer	Matrix	6	Mayer	Quark	6	Mayer	Tea Leaves	5
Mayer	Maverick	3	Mayer	Quattro	1	Mayer	Terrain	3
Mayer	Maze	5	Mayer	Rain Dance	5	Mayer	Theory	2
Mayer	Meander	3	Mayer	Rain Drops	3	Mayer	Time Line	5
Mayer	Melange	3	Mayer	Ranchero	1	Mayer	Toss Up	4
Mayer	Melody	5	Mayer	Rapport	4	Mayer	Tributary	4
Mayer	Metro	4	Mayer	Ratio	6	Mayer	Turnabout	6
Mayer	Microdot	3	Mayer	Razzmatazz	5	Mayer	Tussah	4
Mayer	Milano	4	Mayer	Realm	6	Mayer	Twister	5
Mayer	Monogram	4	Mayer	Rebound	5	Mayer	Uptown	4

Manufacturer	Pattern	Grade	Manufacturer	Pattern	Grade	Manufacturer	Pattern	Grade
Mayer	Valet	3	Momentum	Camber	6	Momentum	Icon	5
Mayer	Variant	2	Momentum	Canter	3	Momentum	Idyll	6
Mayer	Venetian	8	Momentum	Carlo	7	Momentum	Impact	4
Mayer	Venue	4	Momentum	Cashmere II	4	Momentum	Index	6
Mayer	Verona	3	Momentum	Catalogue	6	Momentum	Infinity	1
Mayer	Vibrant	5	Momentum	Central	5	Momentum	Infusion	5
Mayer	Viewpoint	5	Momentum	Centric	6	Momentum	Inner Circle	6
Mayer	Vintage Mohair	9	Momentum	Channel	5	Momentum	Insight	2
Mayer	Vinyl Stat ESD	5	Momentum	Chipper	6	Momentum	Interim	6
Mayer	Vogue	4	Momentum	Cinch	2	Momentum	Intermezzo	6
Mayer	Volante	8	Momentum	Cite	6	Momentum	Intermix II	4
Mayer	Wallaby SP Black	1	Momentum	Clang	3	Momentum	Intersect	3
Mayer	Webscape	5	Momentum	Context	2	Momentum	Interval	2
Mayer	Whimsy	6	Momentum	Core	2	Momentum	Isla	5
Mayer	Whirlwind	2	Momentum	Course	6	Momentum	Jardin	6
Mayer	Wildflower	6	Momentum	Cover Cloth	4	Momentum	Jest	6
Mayer	Willow	3	Momentum	Crossing Colors	7	Momentum	Jitney	5
Mayer	Wool Boucle	7	Momentum	Current	3	Momentum	Juncture	6
Mayer	Xanadu	5	Momentum	Cycle	5	Momentum	Keynote	4
Mayer	Zest	2	Momentum	Dash	6	Momentum	Kindle	5

MOMENTUM

Manufacturer	Pattern	Grade	Manufacturer	Pattern	Grade	Manufacturer	Pattern	Grade
Momentum	Ace	2	Momentum	Dayspell	6	Momentum	Kindred	5
Momentum	Acoustic	6	Momentum	Decode	3	Momentum	Kinney	4
Momentum	Agora II	4	Momentum	Delve	5	Momentum	Knack	2
Momentum	Agora II	4	Momentum	Dive	5	Momentum	Kudos	6
Momentum	Aldo	7	Momentum	Dividend	6	Momentum	Ledge	5
Momentum	Align	6	Momentum	Domain	5	Momentum	Lella	6
Momentum	Allegory	6	Momentum	Drawing Lines	6	Momentum	Lina	7
Momentum	Amenity II	6	Momentum	Drift	6	Momentum	Lineup	2
Momentum	Amuse	4	Momentum	Duo	6	Momentum	Livia	7
Momentum	April	5	Momentum	Ebb	6	Momentum	Lloyd	7
Momentum	Ardour II	6	Momentum	Edison	6	Momentum	Lore	6
Momentum	Arrange	6	Momentum	Effloresce	6	Momentum	Lucio	8
Momentum	Ascend	5	Momentum	Elevate	6	Momentum	Ludwig	7
Momentum	Audio	6	Momentum	Elle	6	Momentum	Malmo	6
Momentum	Audubon	6	Momentum	Emanate	6	Momentum	Mapping Ideas	7
Momentum	Avanti	6	Momentum	Embark	5	Momentum	Marathon	1
Momentum	Avenue	4	Momentum	Eon	3	Momentum	Marcel	7
Momentum	Axis	2	Momentum	Epic	2	Momentum	Medley	5
Momentum	Bandwidth II	5	Momentum	Essay	6	Momentum	Mensa	6
Momentum	Bangle	2	Momentum	Estrella	6	Momentum	Millennium	1
Momentum	Banter	6	Momentum	Evolve	6	Momentum	Mix	6
Momentum	Basis	2	Momentum	Expo	2	Momentum	Molto	6
Momentum	Beeline	3	Momentum	Feliz	6	Momentum	Nagoya	6
Momentum	Beep	4	Momentum	Flection	6	Momentum	Neon	6
Momentum	Bento	6	Momentum	Fleet	5	Momentum	Nifty	4
Momentum	Bias	6	Momentum	Flow	6	Momentum	Nimble	6
Momentum	Bloc	6	Momentum	Flux	6	Momentum	Oath	5
Momentum	Boom II	4	Momentum	Focal	3	Momentum	Odyssey	1
Momentum	Boxcar	6	Momentum	Foray	5	Momentum	Ohs II	7
Momentum	Bravo II	5	Momentum	Free	3	Momentum	Origin	2
Momentum	Brisk	6	Momentum	Fringe	5	Momentum	Pace Crypton	5
Momentum	Buoy	6	Momentum	Fuse	1	Momentum	Pace Incase	5
Momentum	Cairns	6	Momentum	Geo	6	Momentum	Painting Strokes	6
			Momentum	Habit	3	Momentum	Panorama	6
			Momentum	Hearsay	6	Momentum	Parable	6
			Momentum	Helm	5	Momentum	Parkside Crypton	5
			Momentum	Hive	5	Momentum	Parkside Incase	5
			Momentum	Hue	3	Momentum	Perk	2
			Momentum	Hula	6	Momentum	Photon	6

Graded In Fabrics

Manufacturer	Pattern	Grade	Manufacturer	Pattern	Grade
Momentum	Pierre	7	Momentum	Twist	6
Momentum	Ping	4	Momentum	Upside	5
Momentum	Pique	4	Momentum	Vario	4
Momentum	Propensity	3	Momentum	Veer	5
Momentum	Prospect	5	Momentum	Velocity	4
Momentum	Proximity	6	Momentum	Venue	4
Momentum	Quirk	4	Momentum	Via	3
Momentum	Rally	6	Momentum	Viva II	5
Momentum	Recollection II	6	Momentum	Vox	2
Momentum	Redux	5	Momentum	Wander	6
Momentum	Rein II	5	Momentum	Waver	5
Momentum	Revolve	6	Momentum	Weaving Palettes	6
Momentum	Riga	6	Momentum	Whim	6
Momentum	Rivet	4	Momentum	Zola	6
Momentum	Row	5			
Momentum	Sail	6			
Momentum	Scan	6			
Momentum	Scape	6			
Momentum	Scrabble	3			
Momentum	Scribe	5			
Momentum	Sense	5			
Momentum	Sidebar Crypton	5			
Momentum	Sidebar Incase	5			
Momentum	Sidestep	6			
Momentum	Silica	7			
Momentum	Silica Breeze	7			
Momentum	Silica Etch	7			
Momentum	Silica Hiatus	7			
Momentum	Silica Leather	7			
Momentum	Silica Prints	7			
Momentum	Silica Reach	7			
Momentum	Silica Stride	7			
Momentum	Silica Tech	7			
Momentum	Sketching Air	7			
Momentum	Skip	3			
Momentum	Small Talk	6			
Momentum	Solace	4			
Momentum	Solo2	5			
Momentum	Soma	6			
Momentum	Sort	6			
Momentum	Span Crypton	5			
Momentum	Span Incase	5			
Momentum	Spin	6			
Momentum	Starboard	6			
Momentum	Strut	4			
Momentum	Sublime II	5			
Momentum	Sway II	5			
Momentum	Symbol	7			
Momentum	Synergy	5			
Momentum	Syntax	3			
Momentum	Tactic	6			
Momentum	Tesla	6			
Momentum	Tetra	4			
Momentum	Tone	5			
Momentum	Torque	6			
Momentum	Tradition	2			
Momentum	Trefoil	5			
Momentum	Trove	6			
Momentum	Turin	6			

VICTOR		
Manufacturer	Pattern	Grade
Victor	Artesian	4
Victor	Astral	3
Victor	Baroque	3
Victor	Blink	1
Victor	Connection	3
Victor	Couture	1
Victor	Eco Wool	5
Victor	Facet	2
Victor	High Line	3
Victor	Kevala	3
Victor	Martini	3
Victor	Orbit	3
Victor	Palazo	3
Victor	Particule	2
Victor	Pebbles	1
Victor	Perennial	2
Victor	Pergola	2
Victor	Punch Card	1
Victor	Quadrille	2
Victor	Relay	2
Victor	Riviere	3
Victor	Safari	2
Victor	Shazam	2
Victor	Staccatto	4
Victor	Stitch	1
Victor	Terra (arizona)	3
Victor	Titan	3
Victor	To The Point	2
Victor	Willows	5
Victor	Windmill	5

NeutralPosture

GSA	NeutralPosture.com
SCS Indoor Advantage	3904 N. Texas Ave.
BIFMA e3/LEVEL	Bryan, TX 77803
ISO 9001:2008 Approved	T 979.778.0502
Made in the U.S.A.	F 979.778.0408